

РАСКРАСКИ ПЛЮС!

# РАСКРАСКИ - ПРОПИСИ

Скажи, герой какой сказки  
изображён на этой картинке.

1

б б

6 6



Проведи карандашом точно по линиям,  
постарайся не отрывать карандаш от бумаги.  
Раскрась картинку.

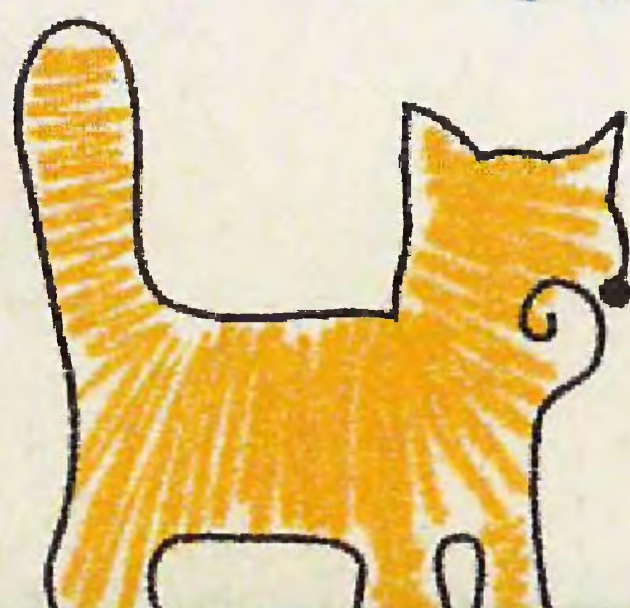

Л  
ЛЕВ



Перед тобой все буквы нашего алфавита. Обведи в кружочек те из них, которые составляют твоё имя. Раскрась картинку.



# A

Антилопа

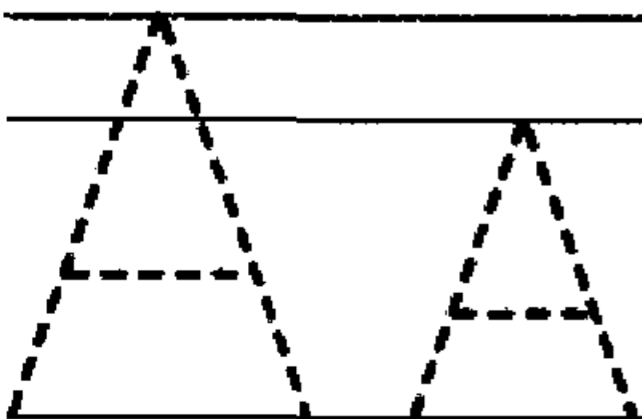
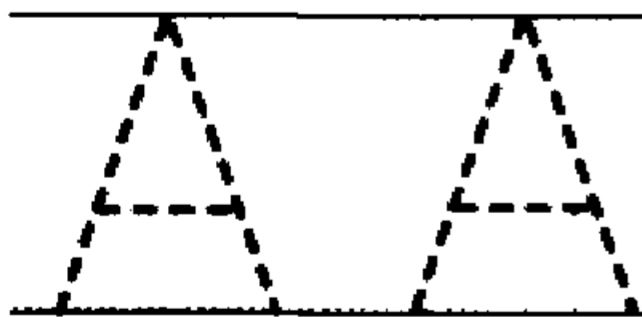
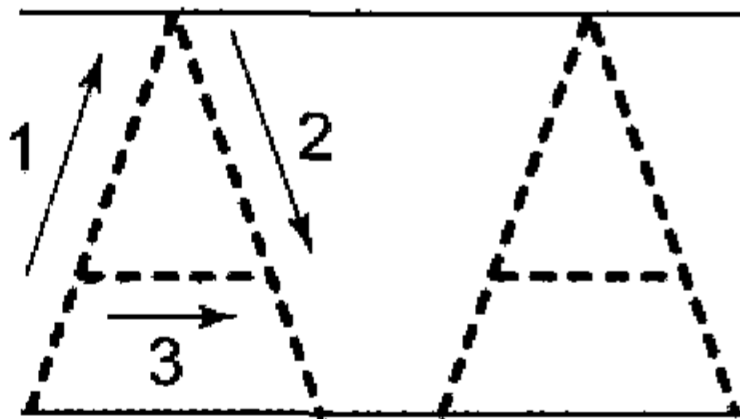
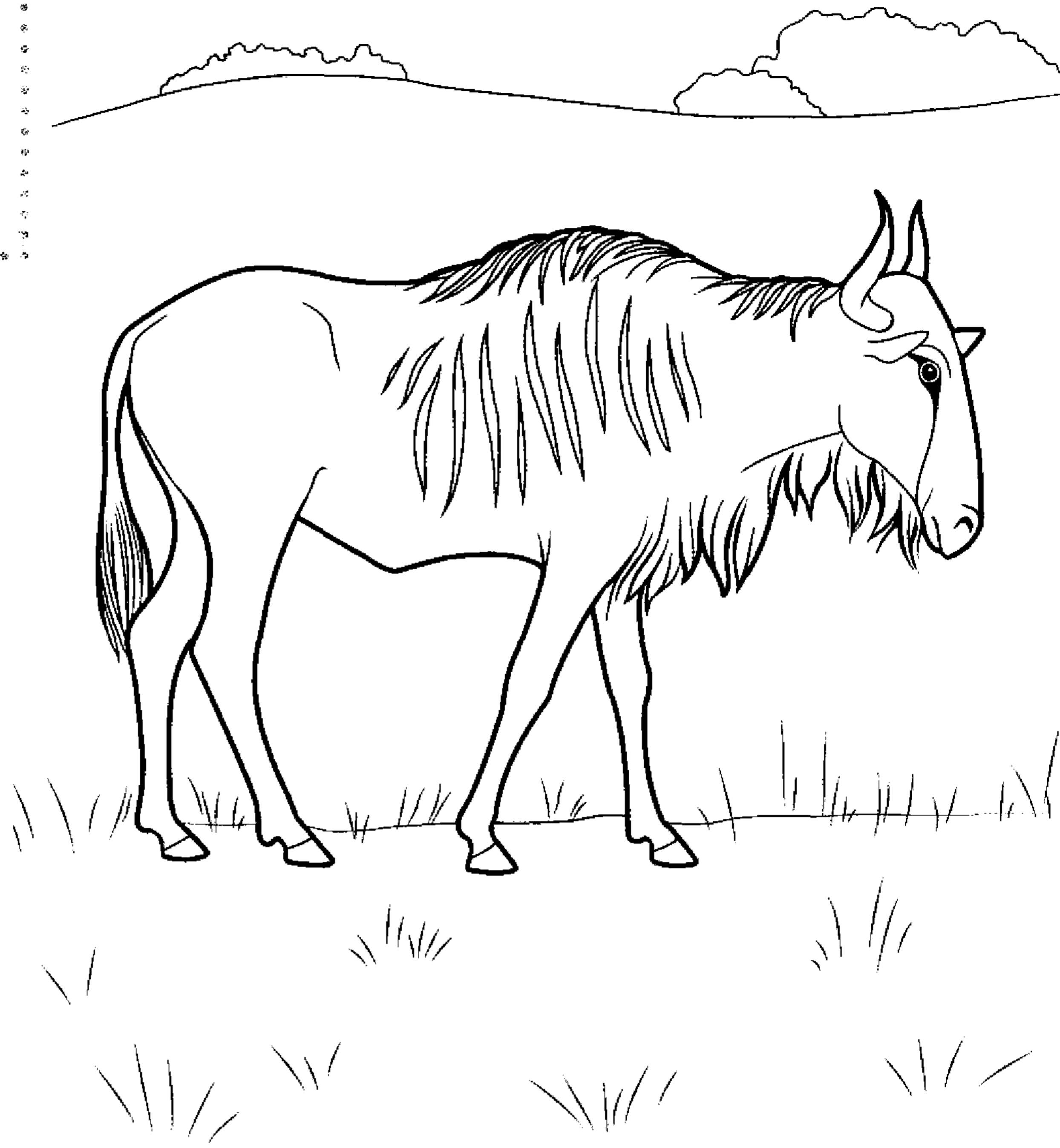

Дорисуй фигуры до конца строки и раскрась их.

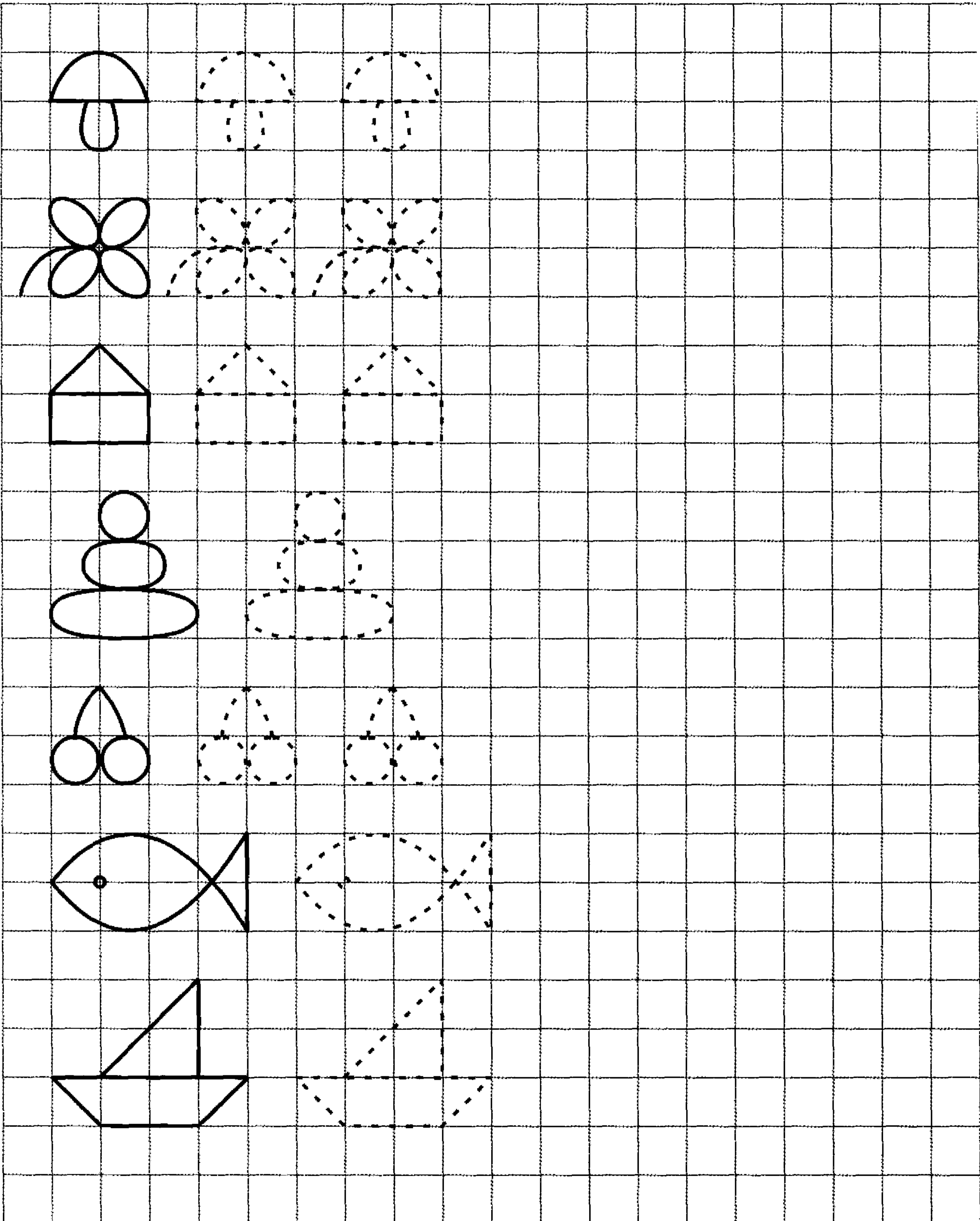

# Б

Белка

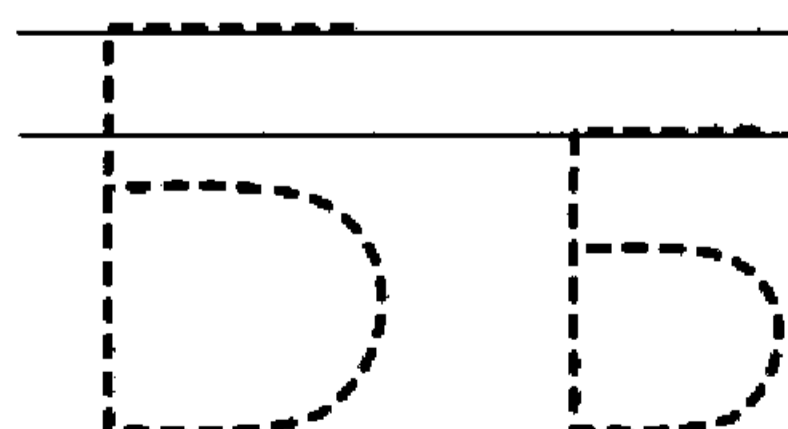
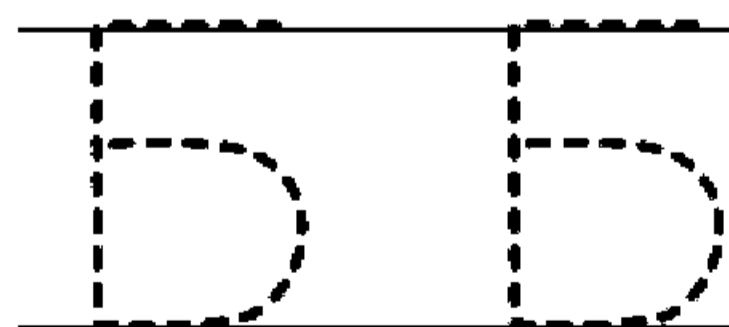
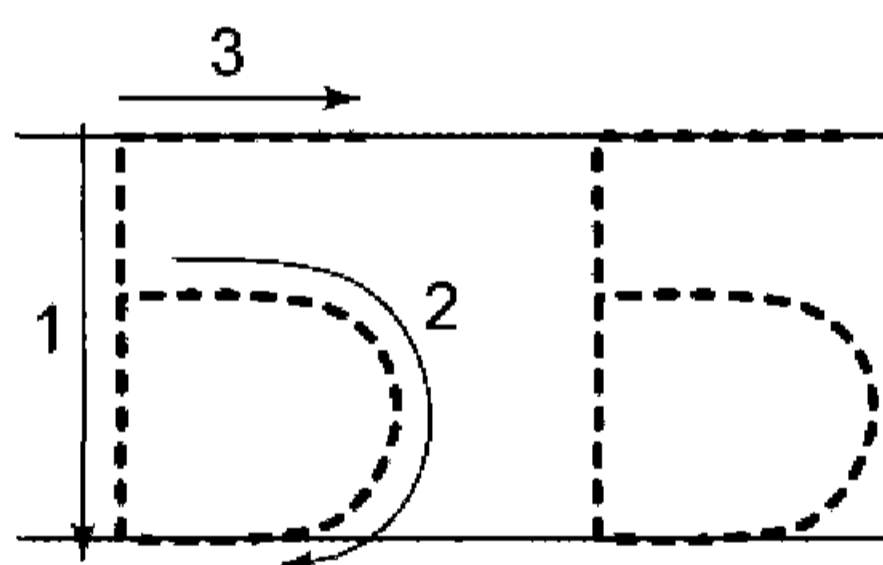

Проведи карандашом точно по линиям, постарайся не отрывать карандаш от бумаги. Раскрась картинки.

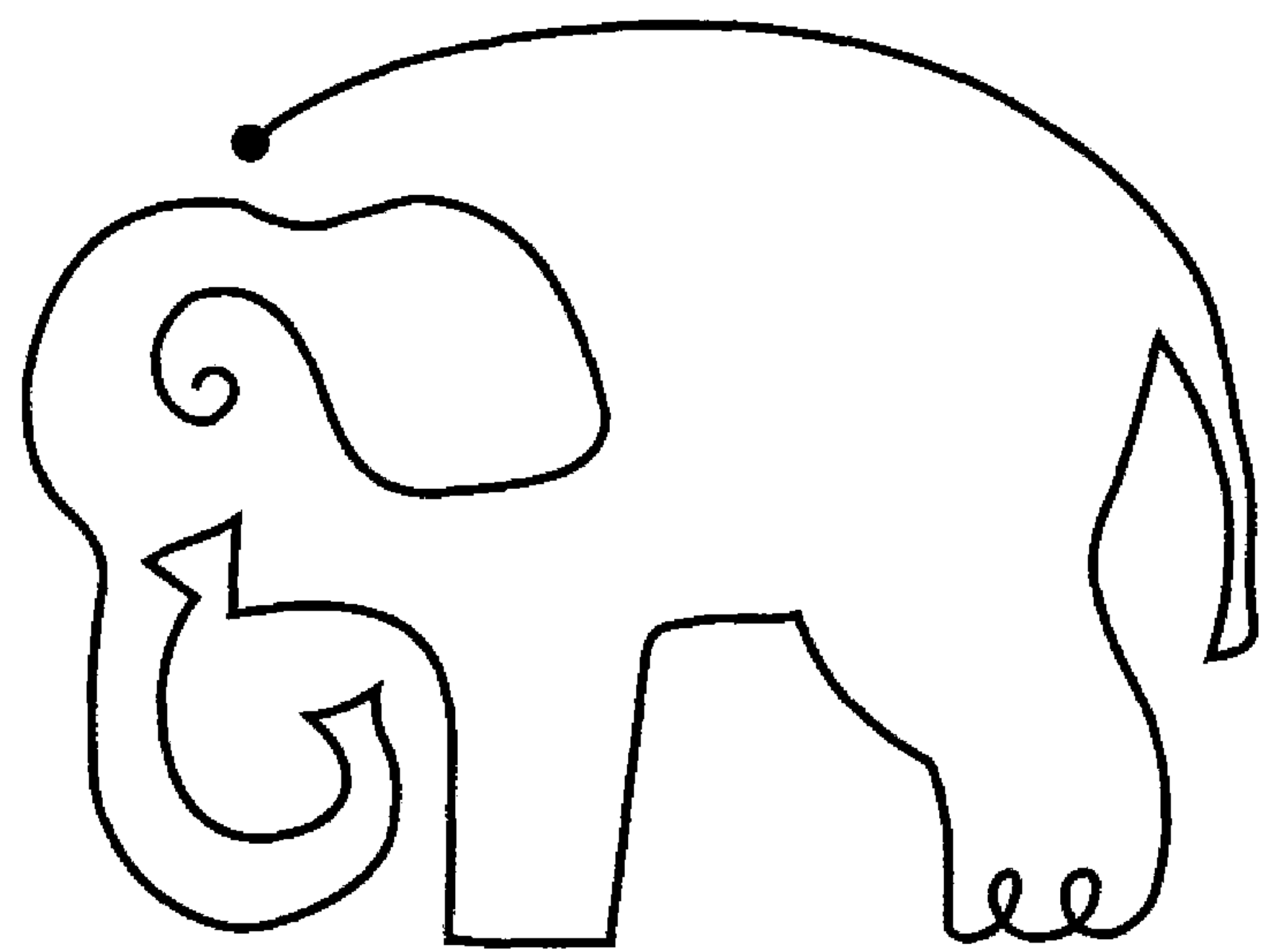
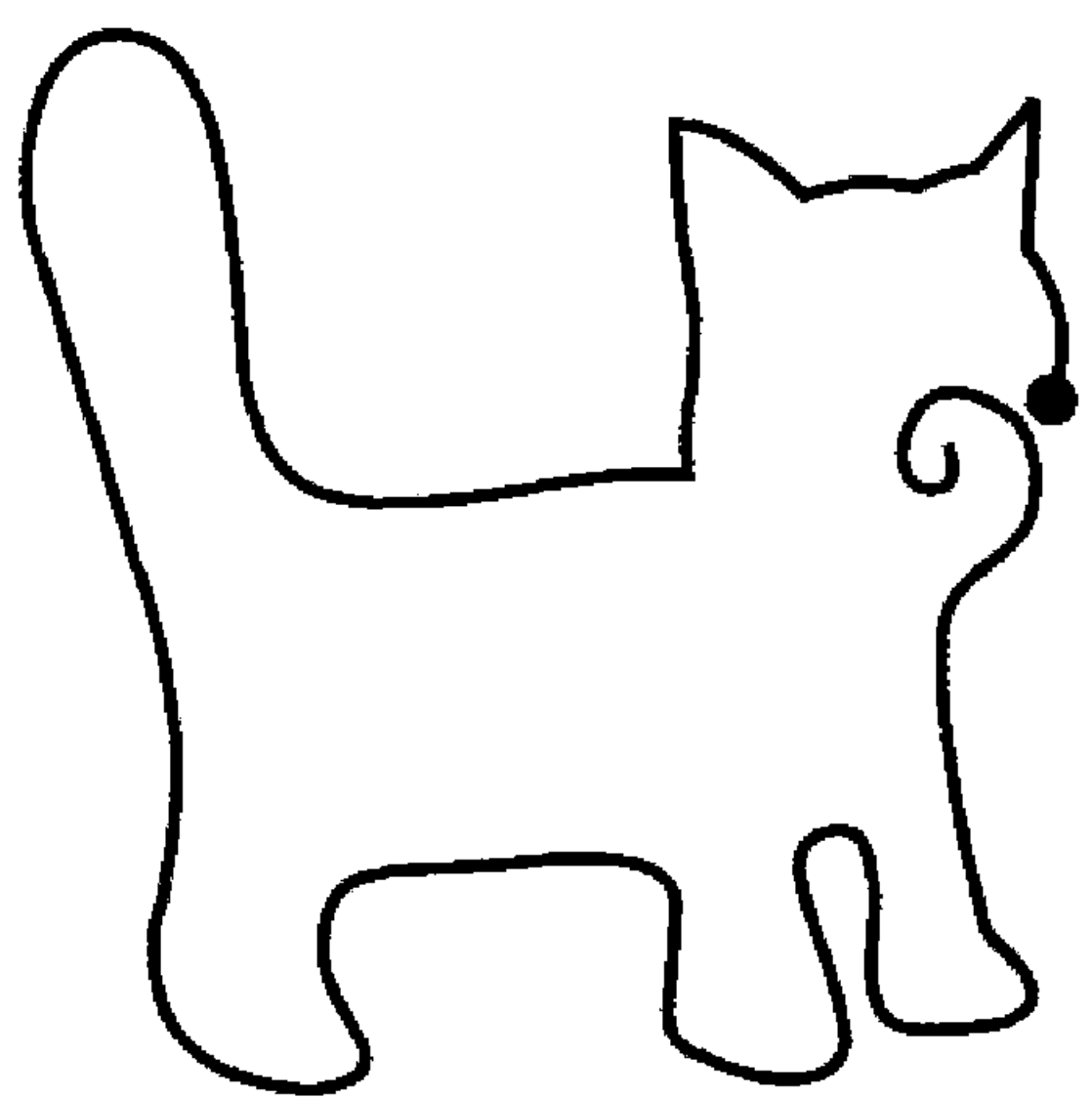
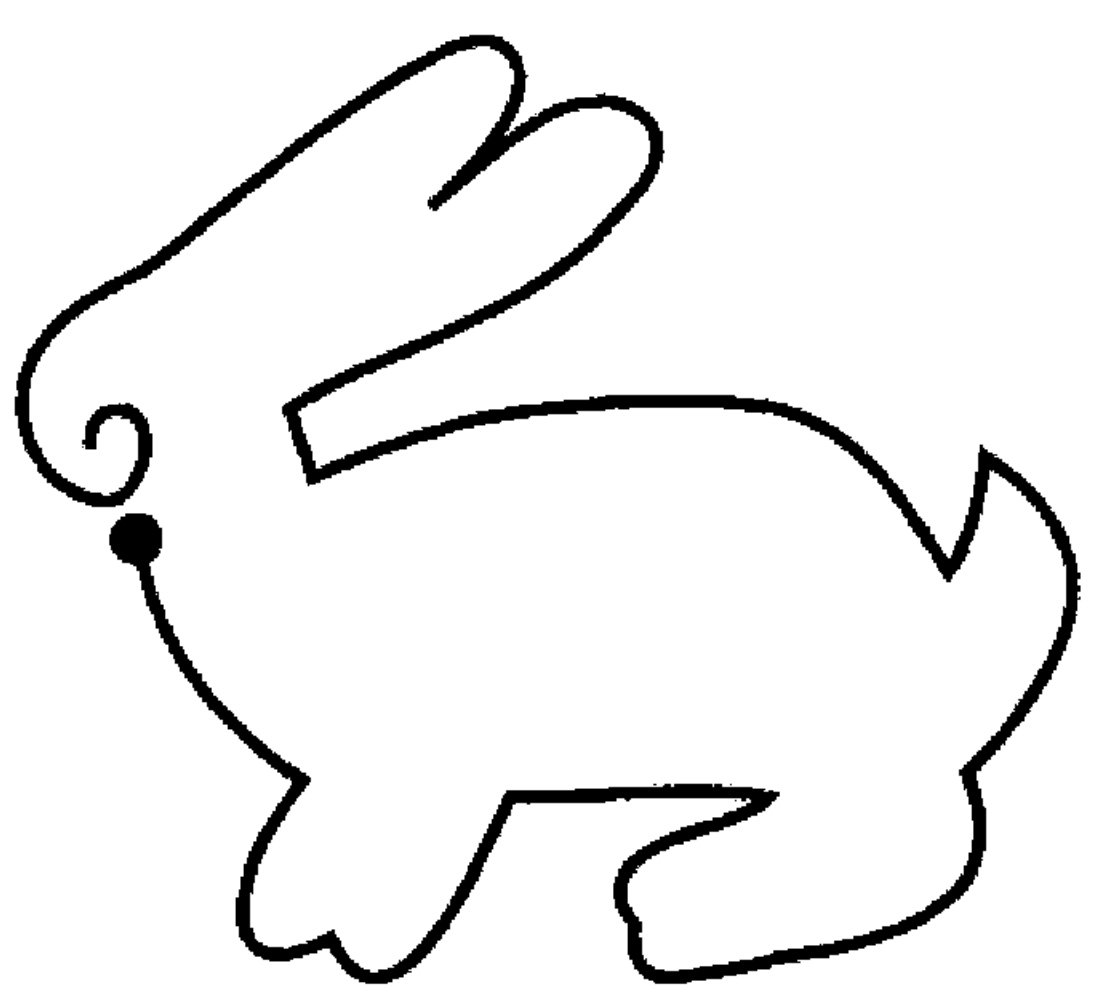
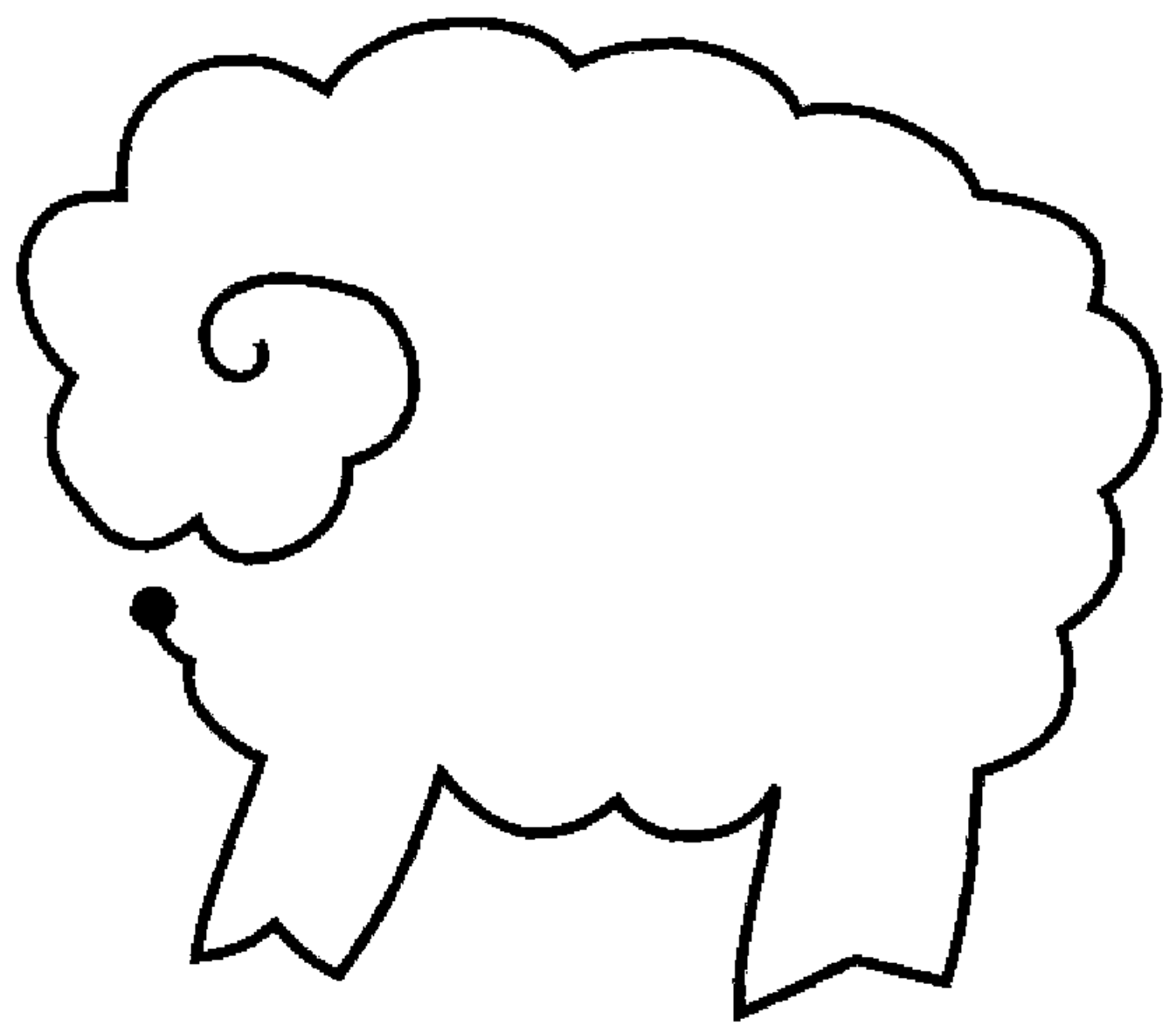
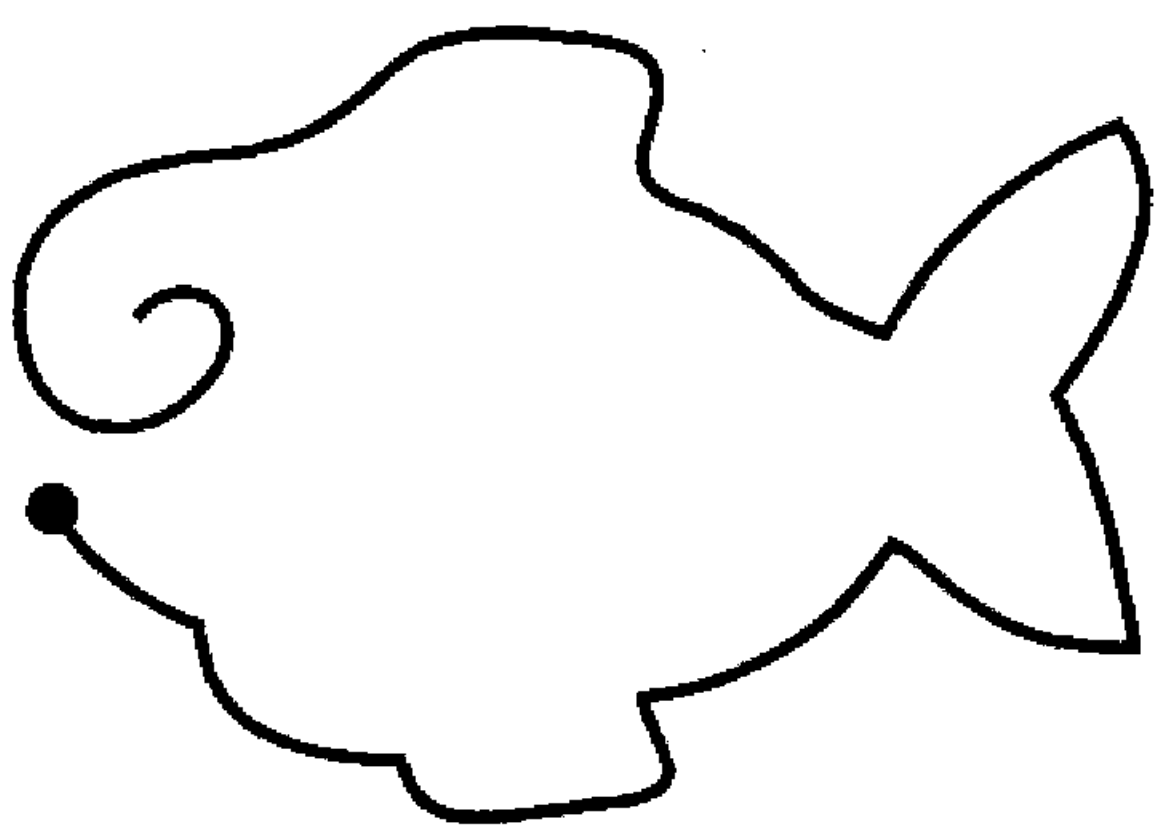

# В

Верблюд

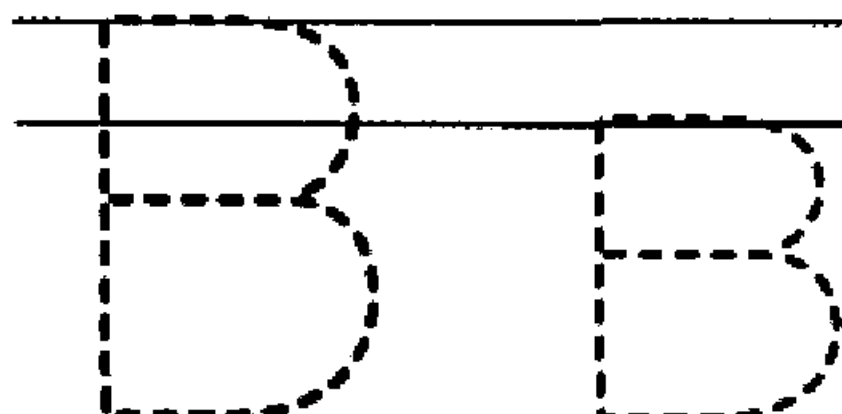
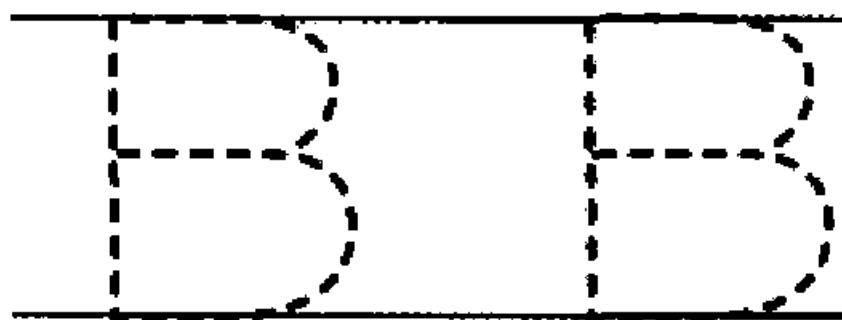
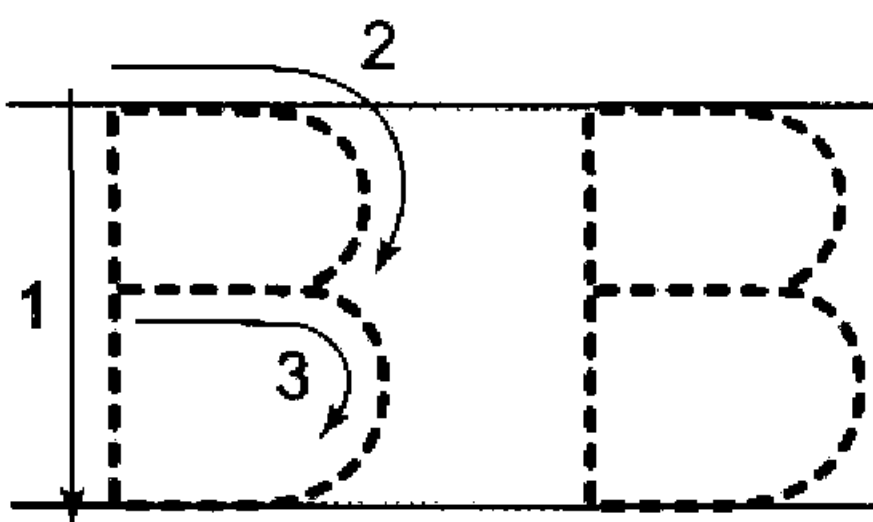
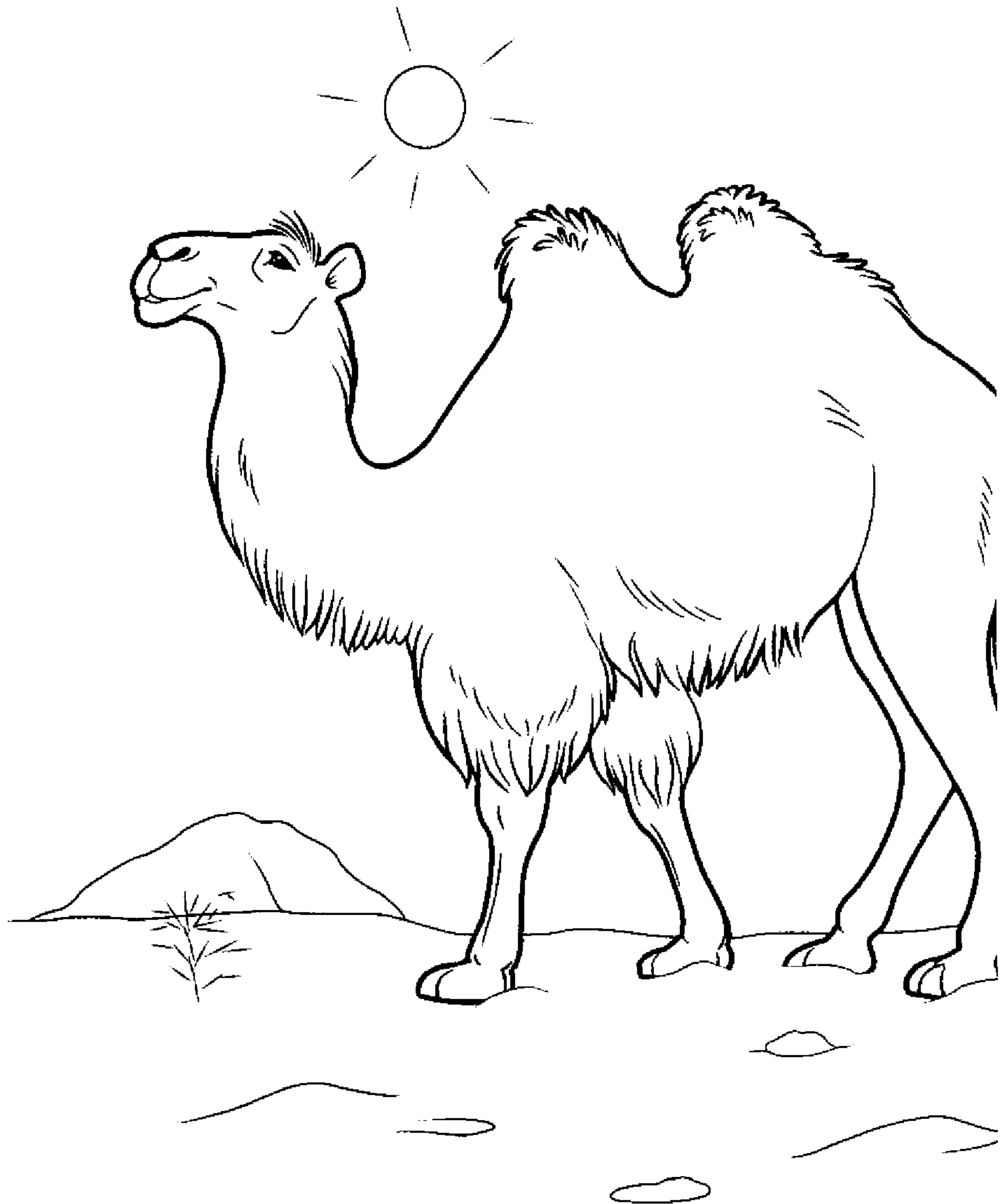

Дорисуй вторые половинки предметов и раскрась картинки.

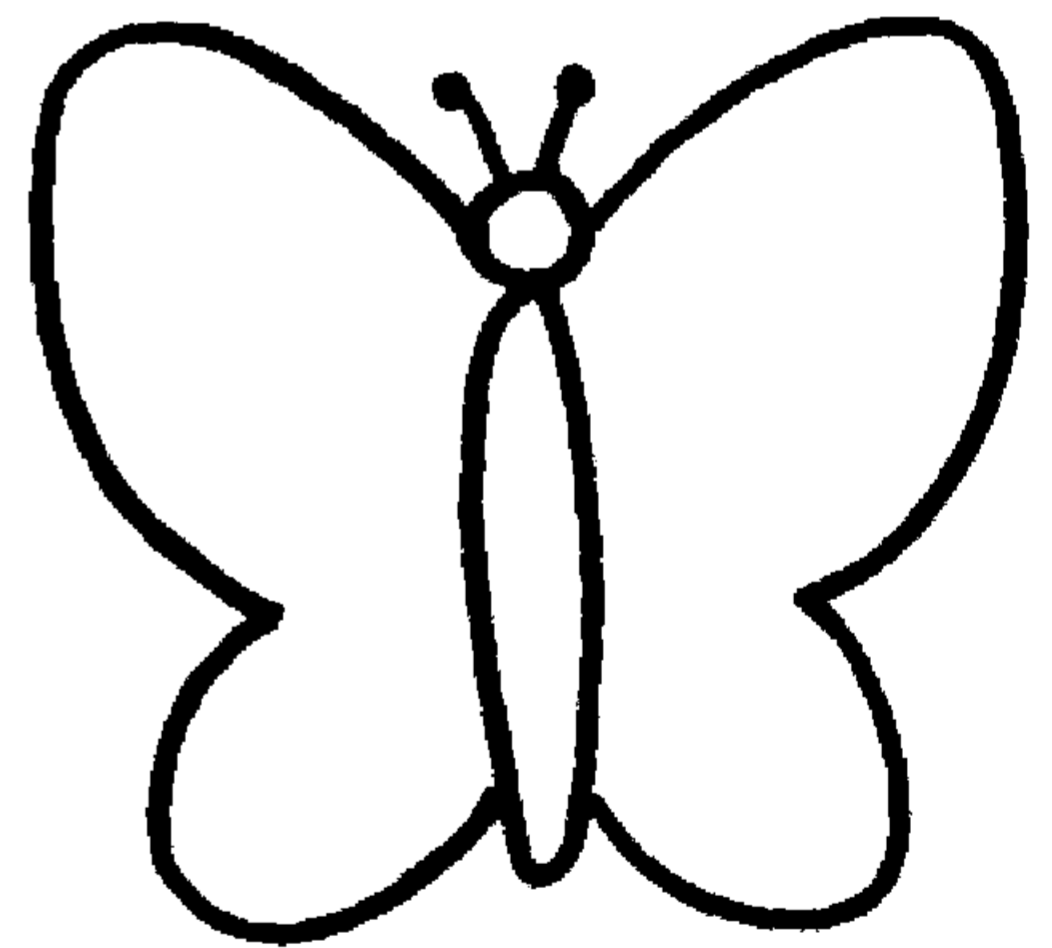
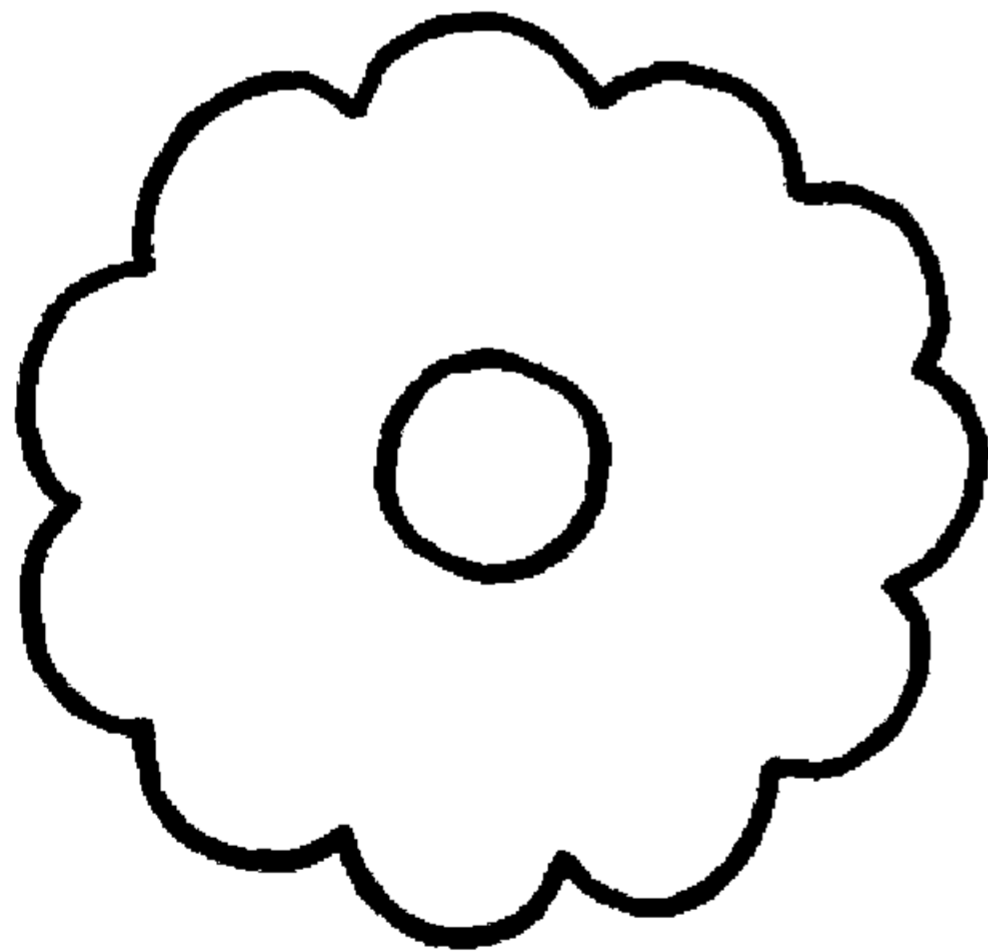
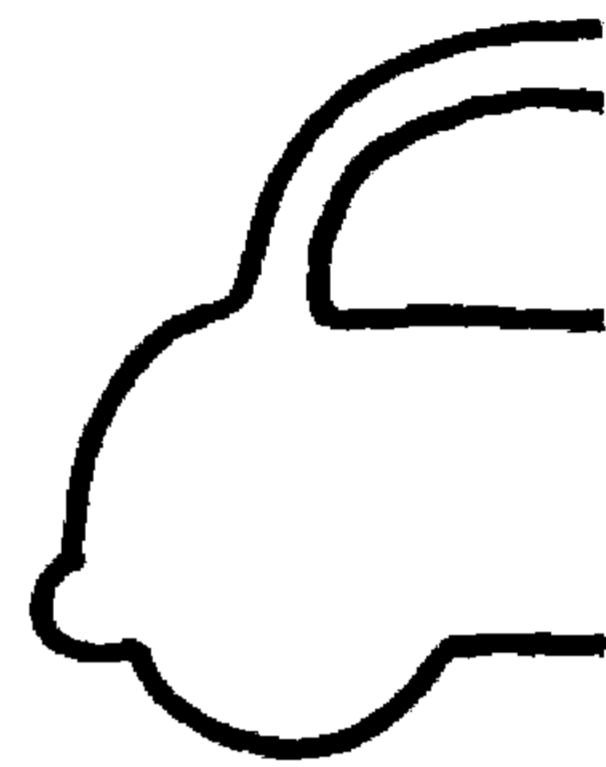
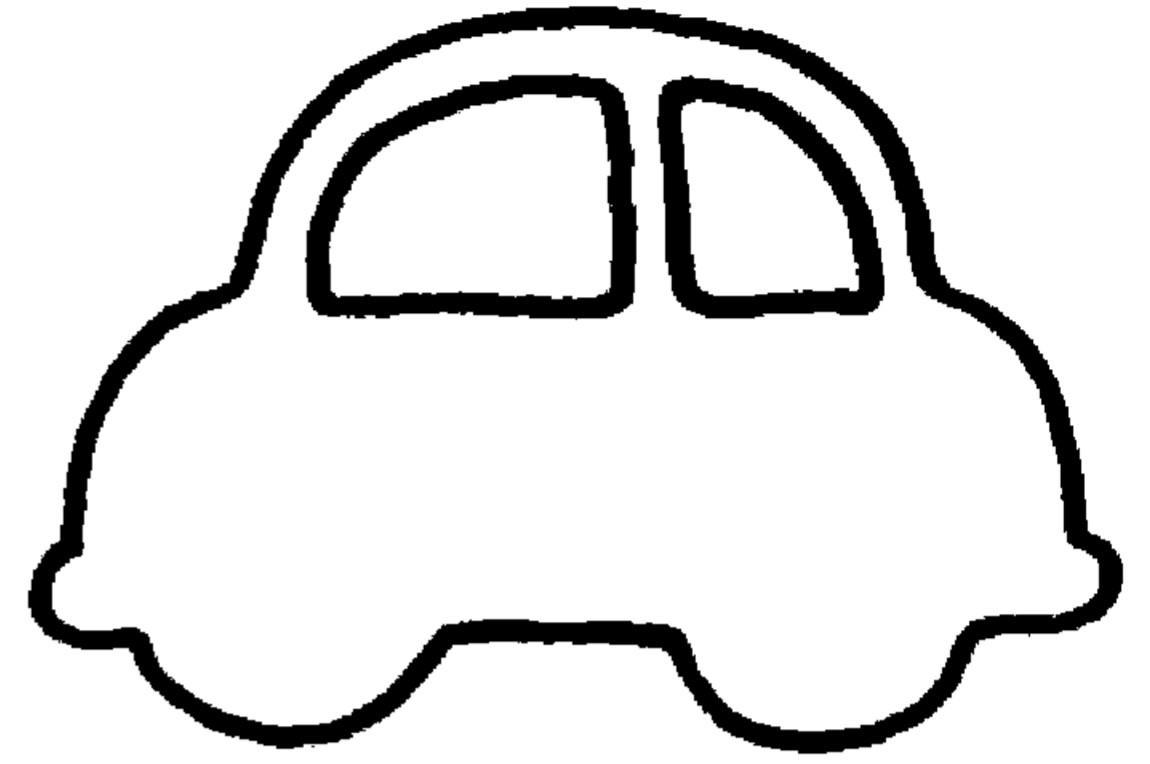
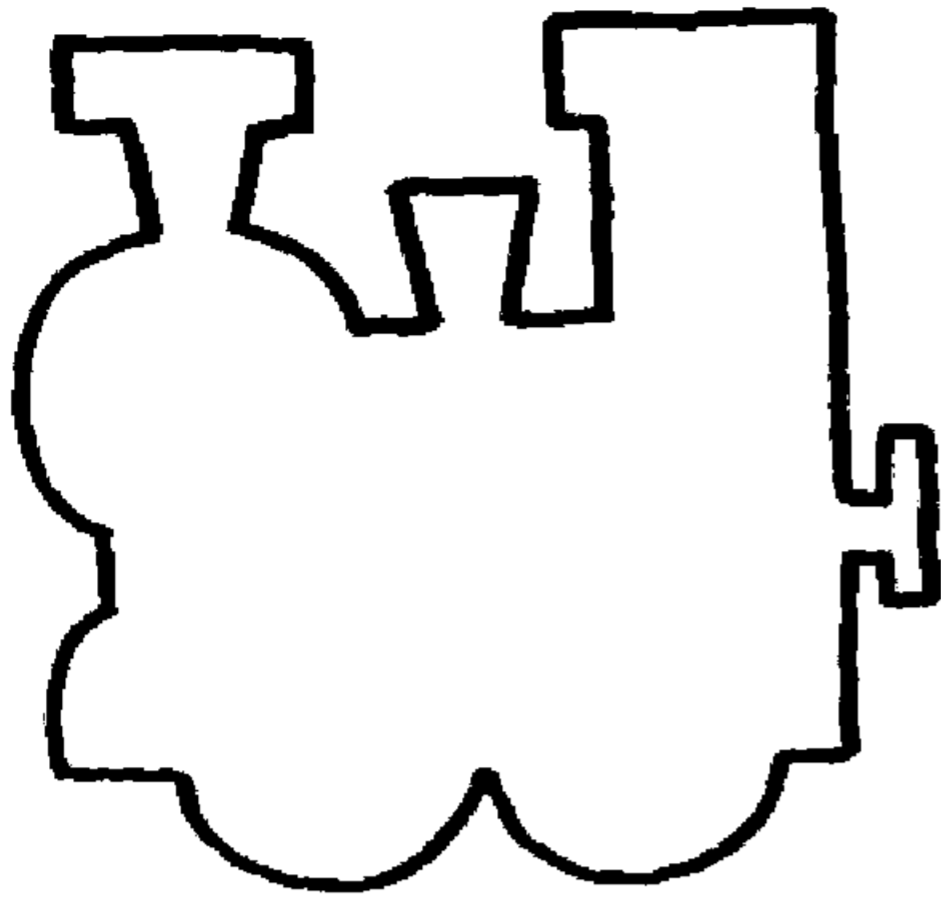



Г

Глухарь

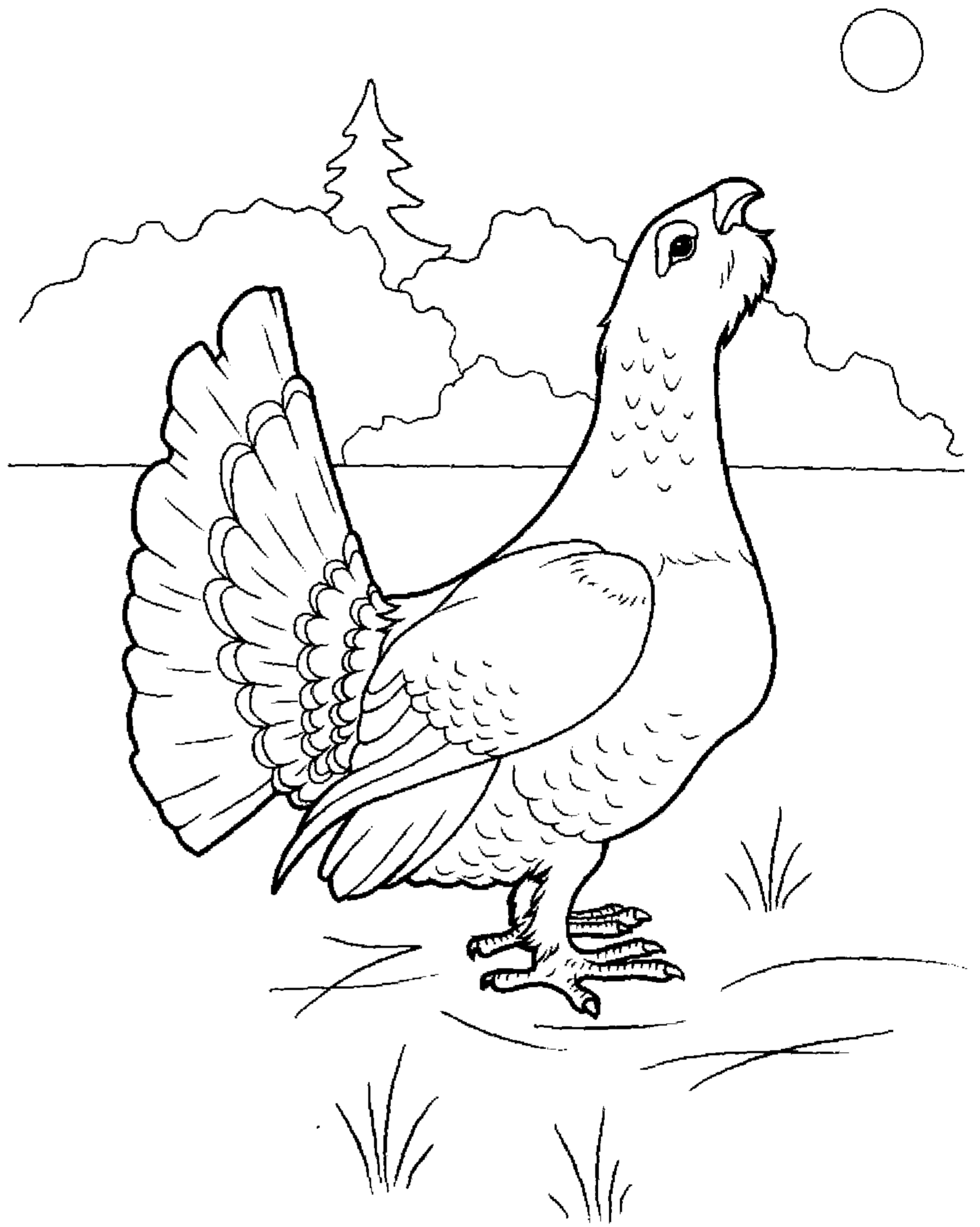

2 →

1 ↓

Нарисуй справа по клеточкам точно такие же предметы и раскрась их.

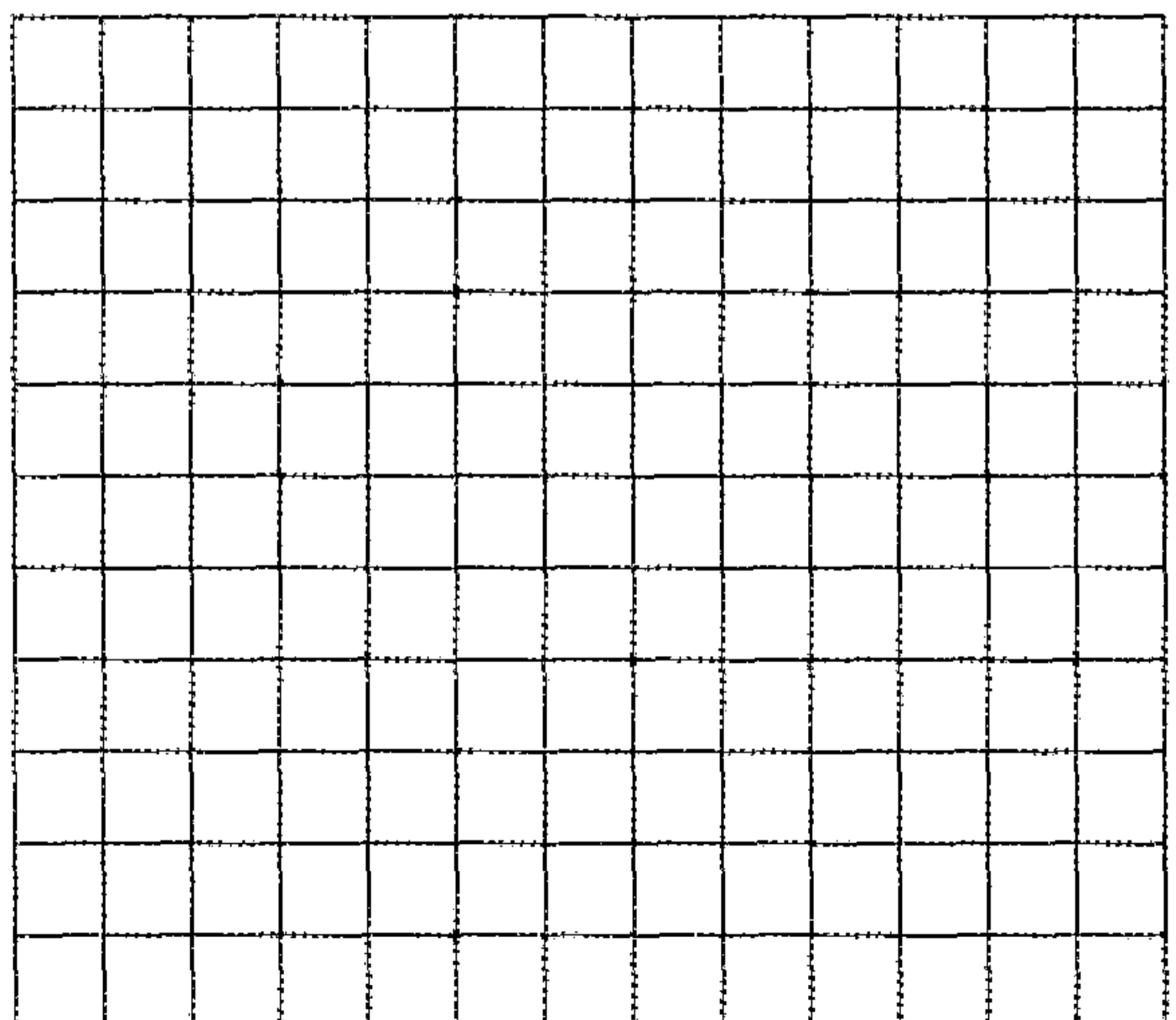
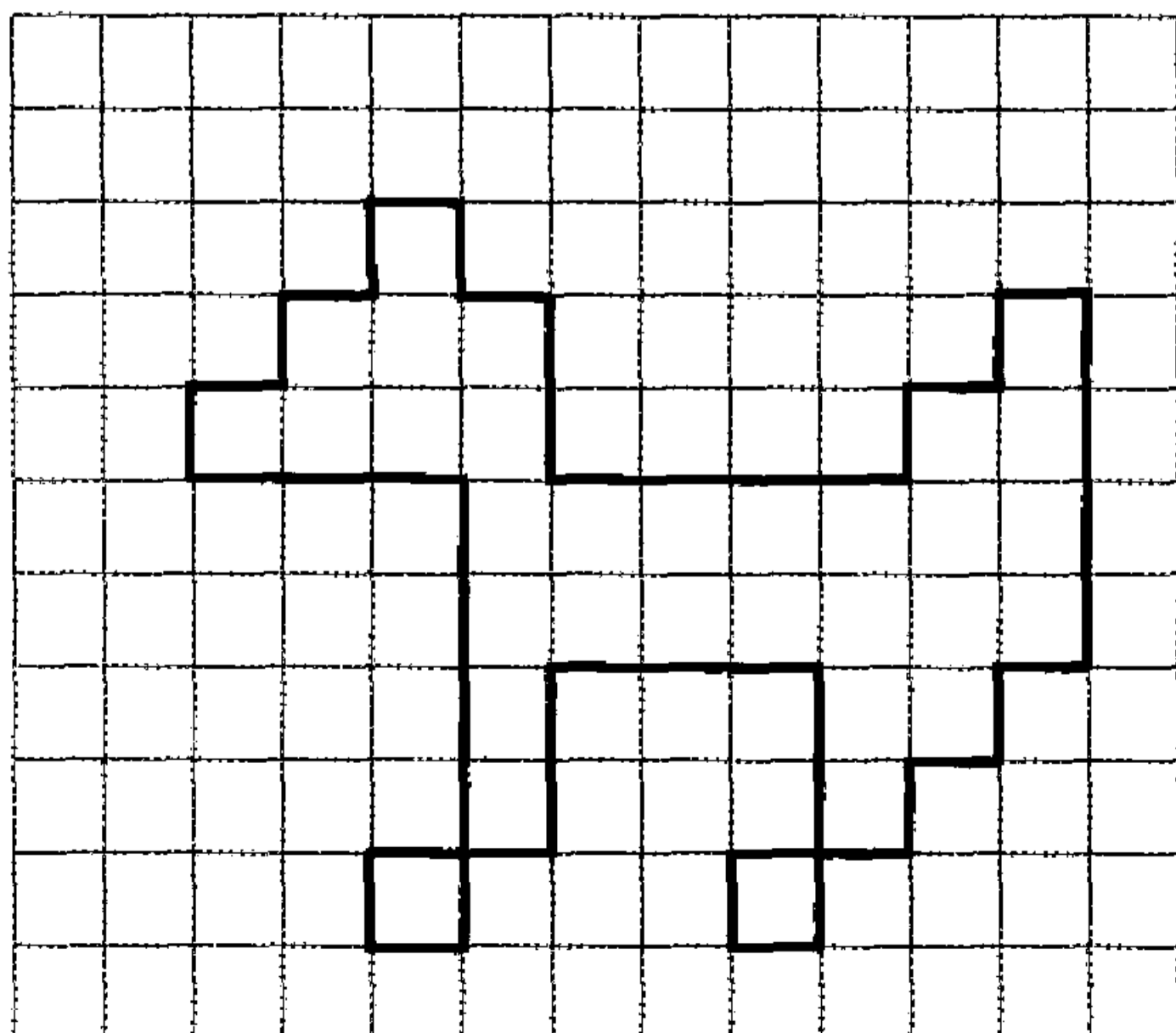
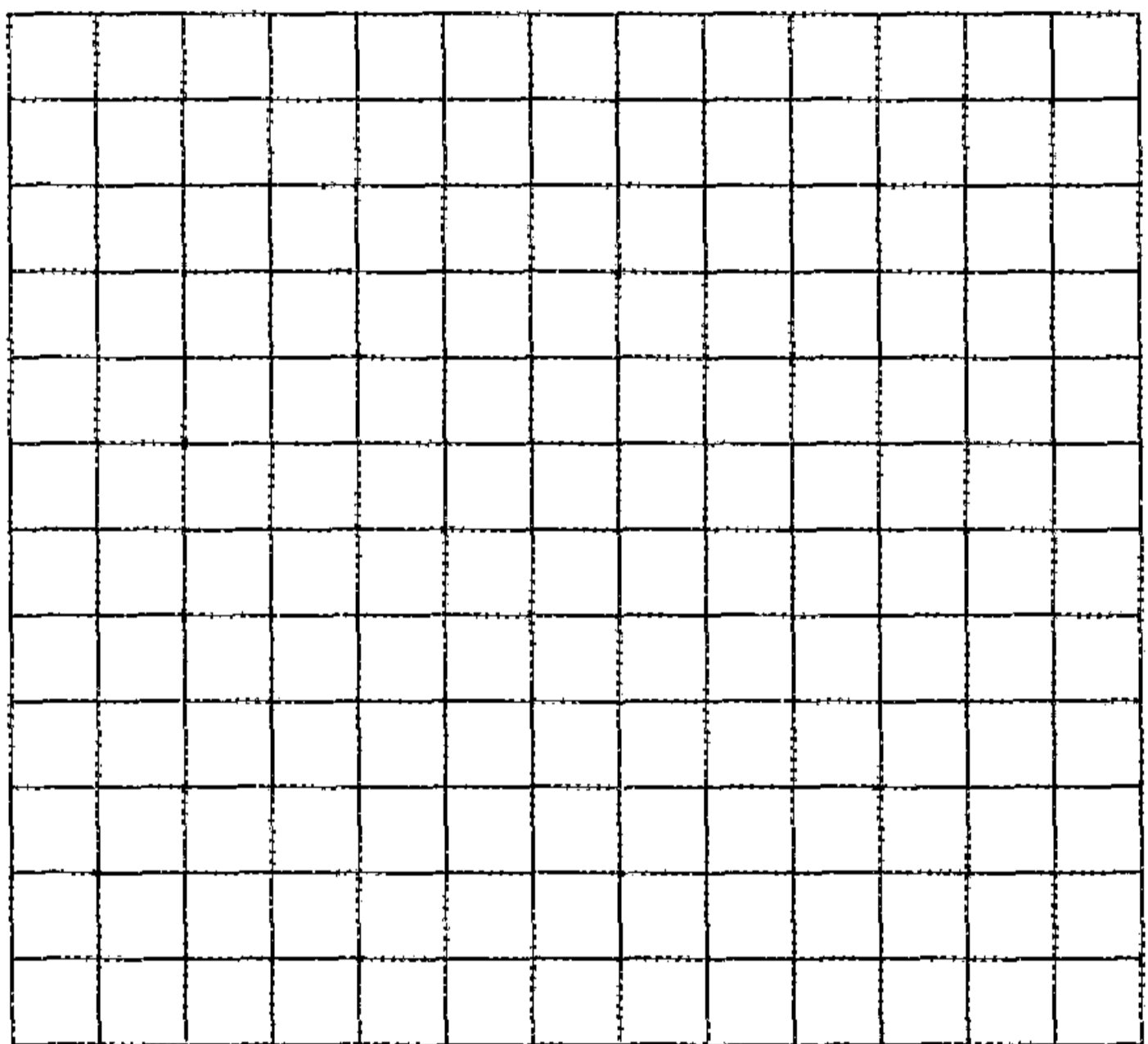
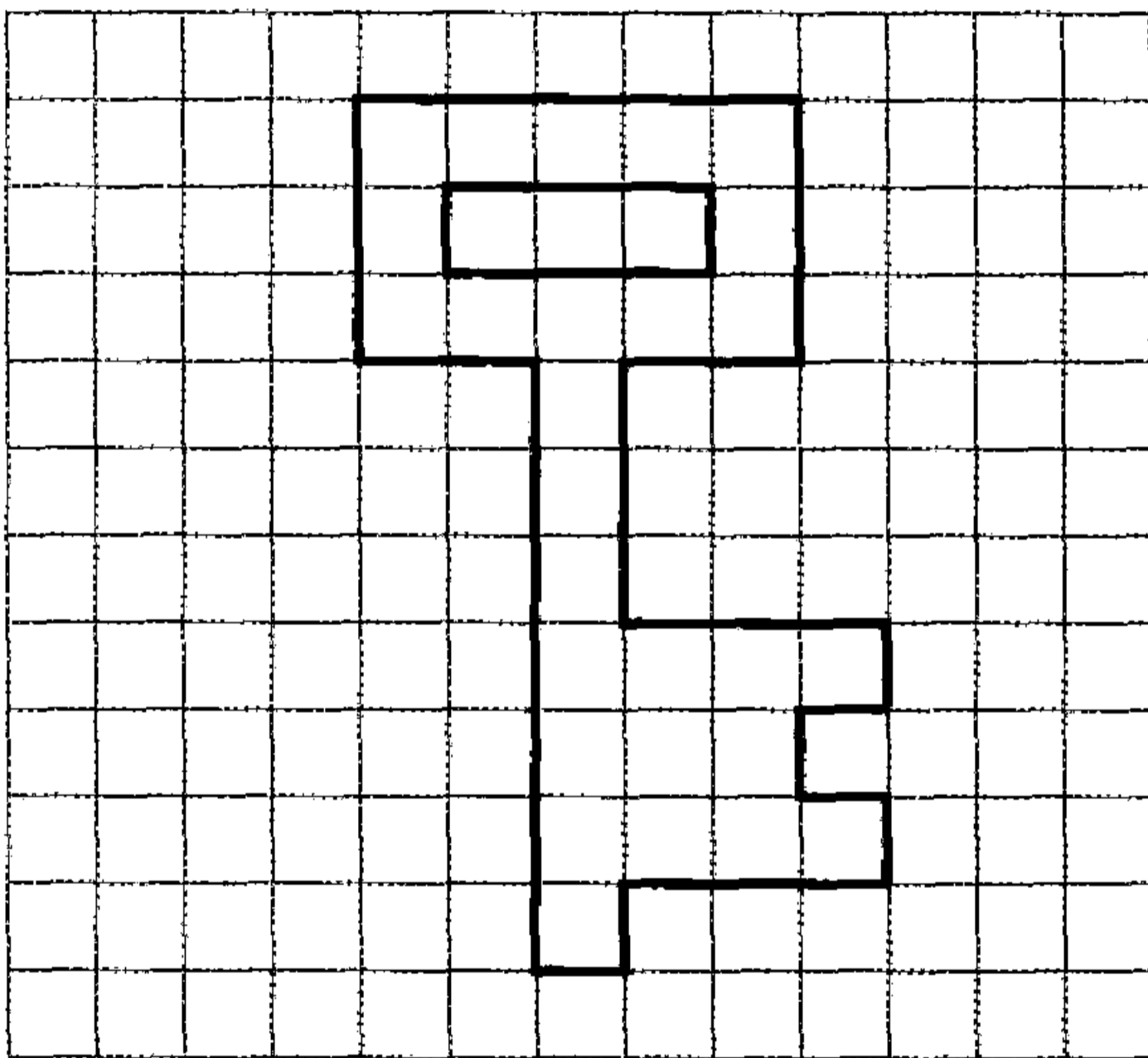
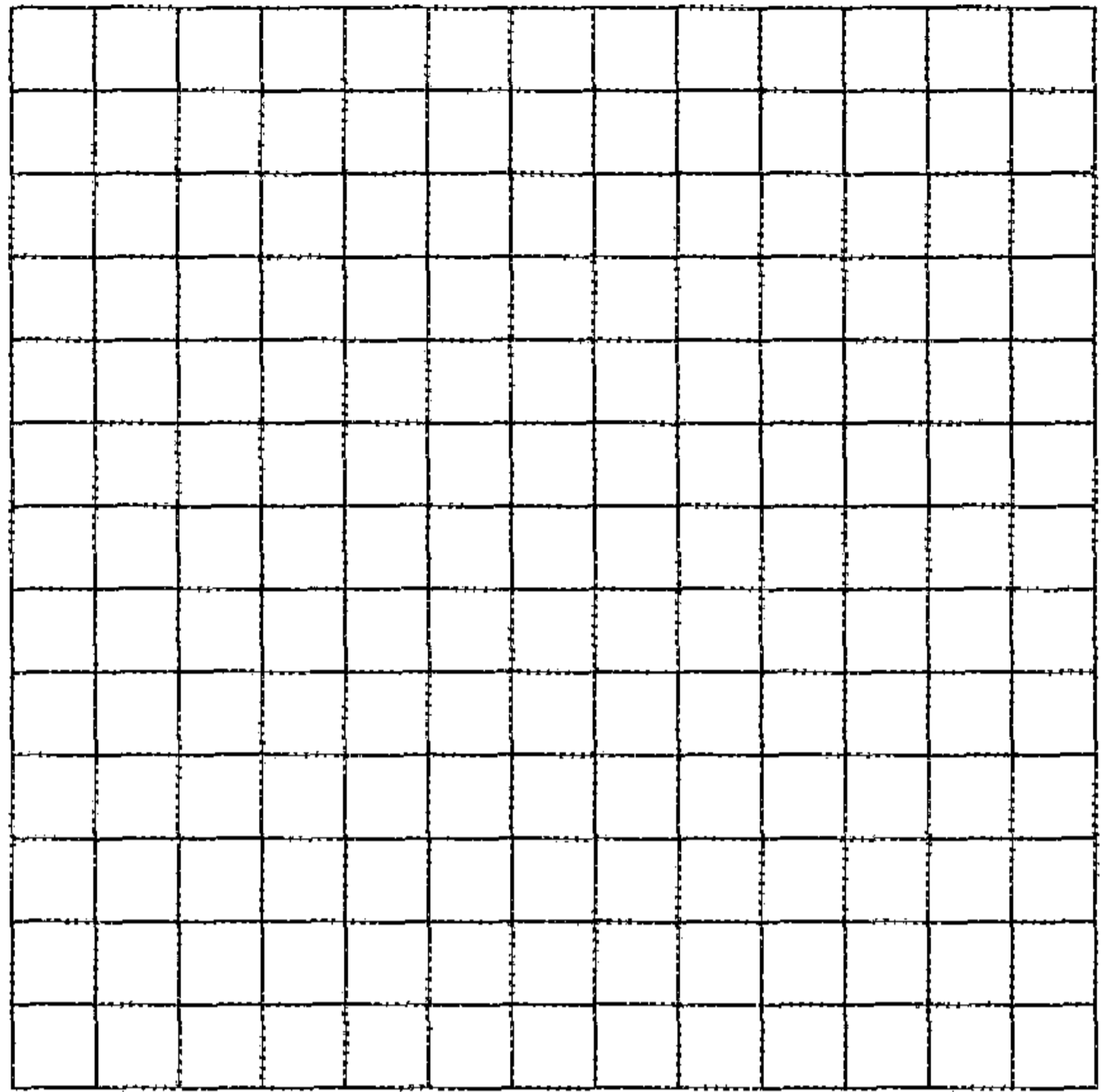
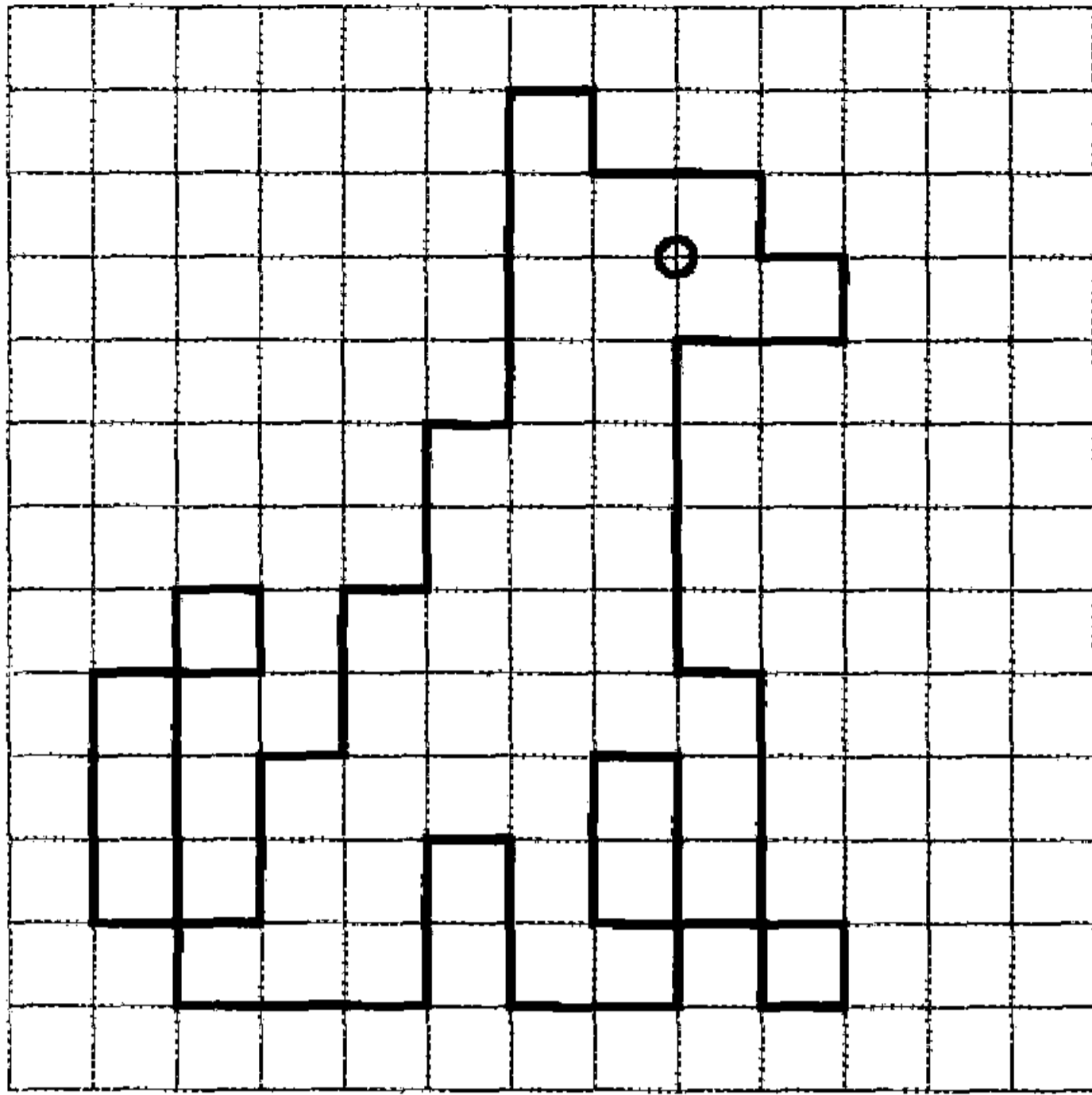

# Д

Динозавр

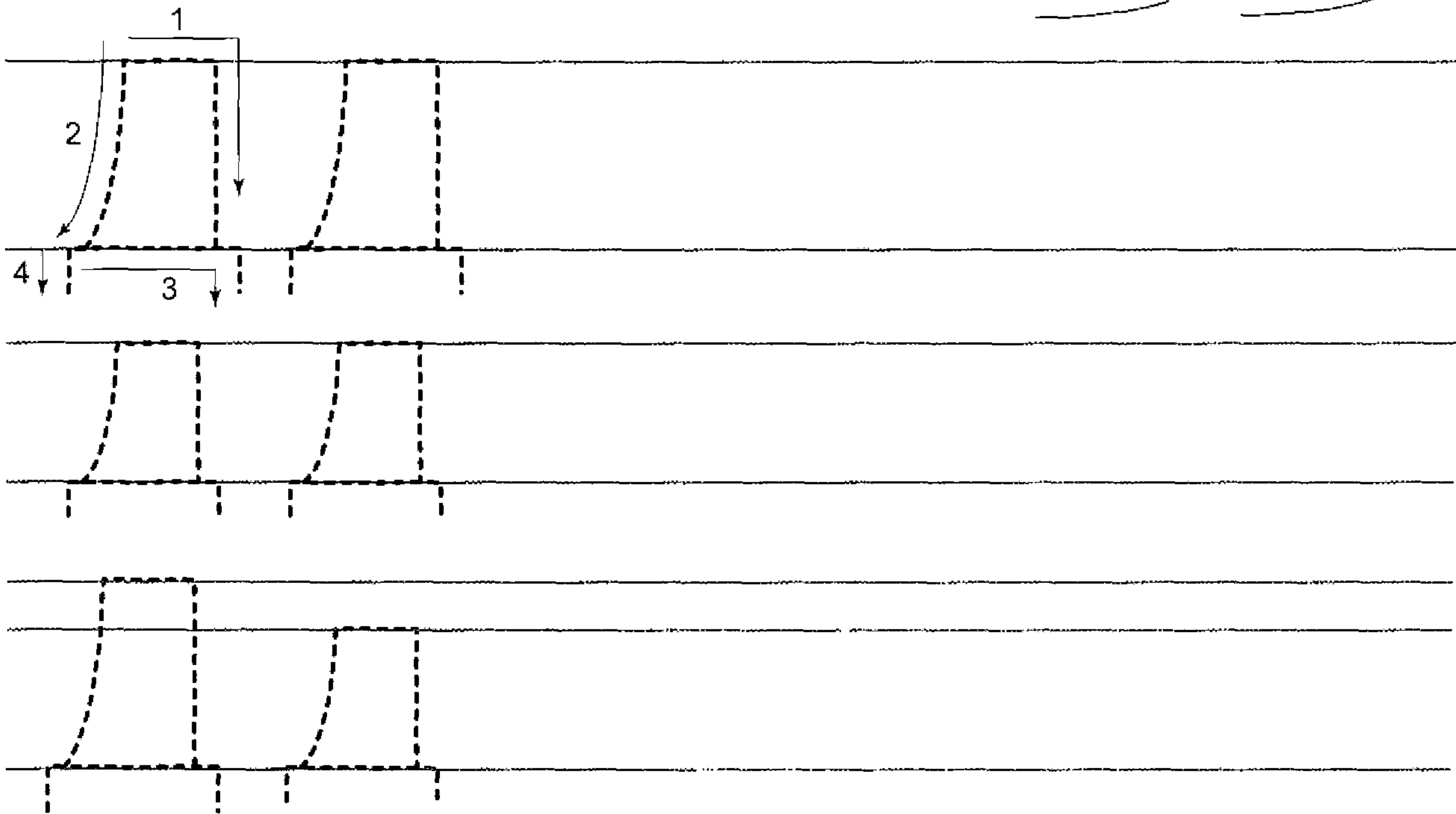

Выполни штриховку прямыми линиями, не выходя за контур рисунка. Раскрась картинку.

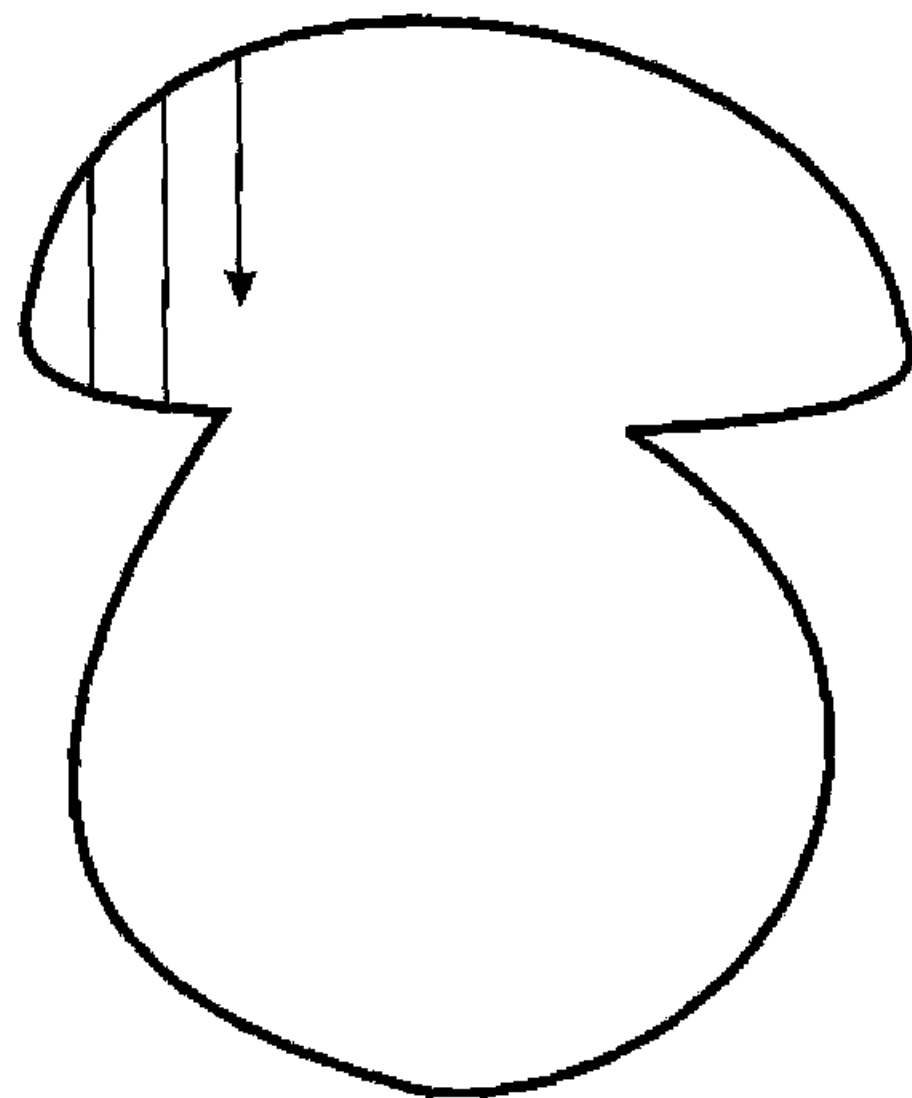
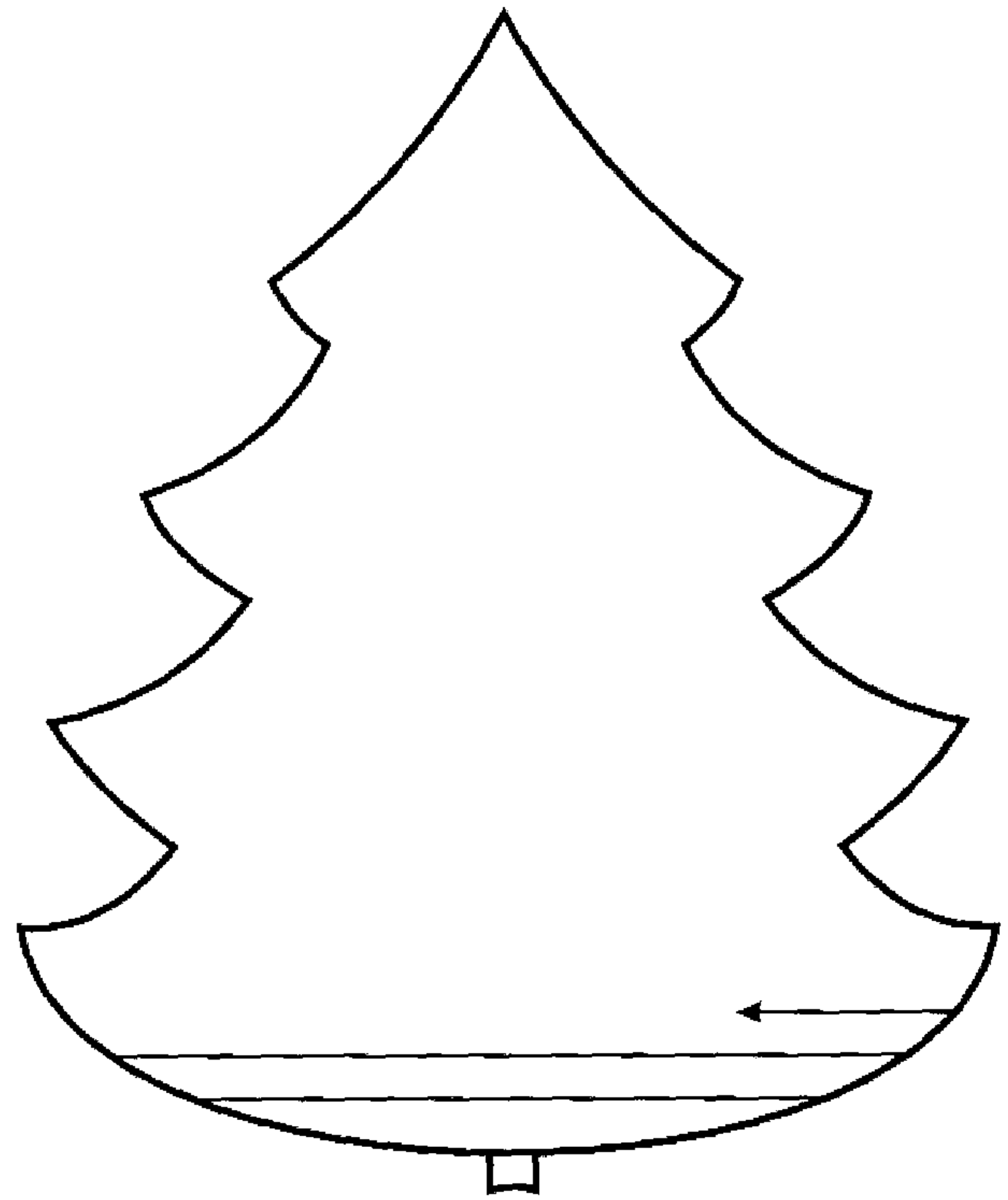
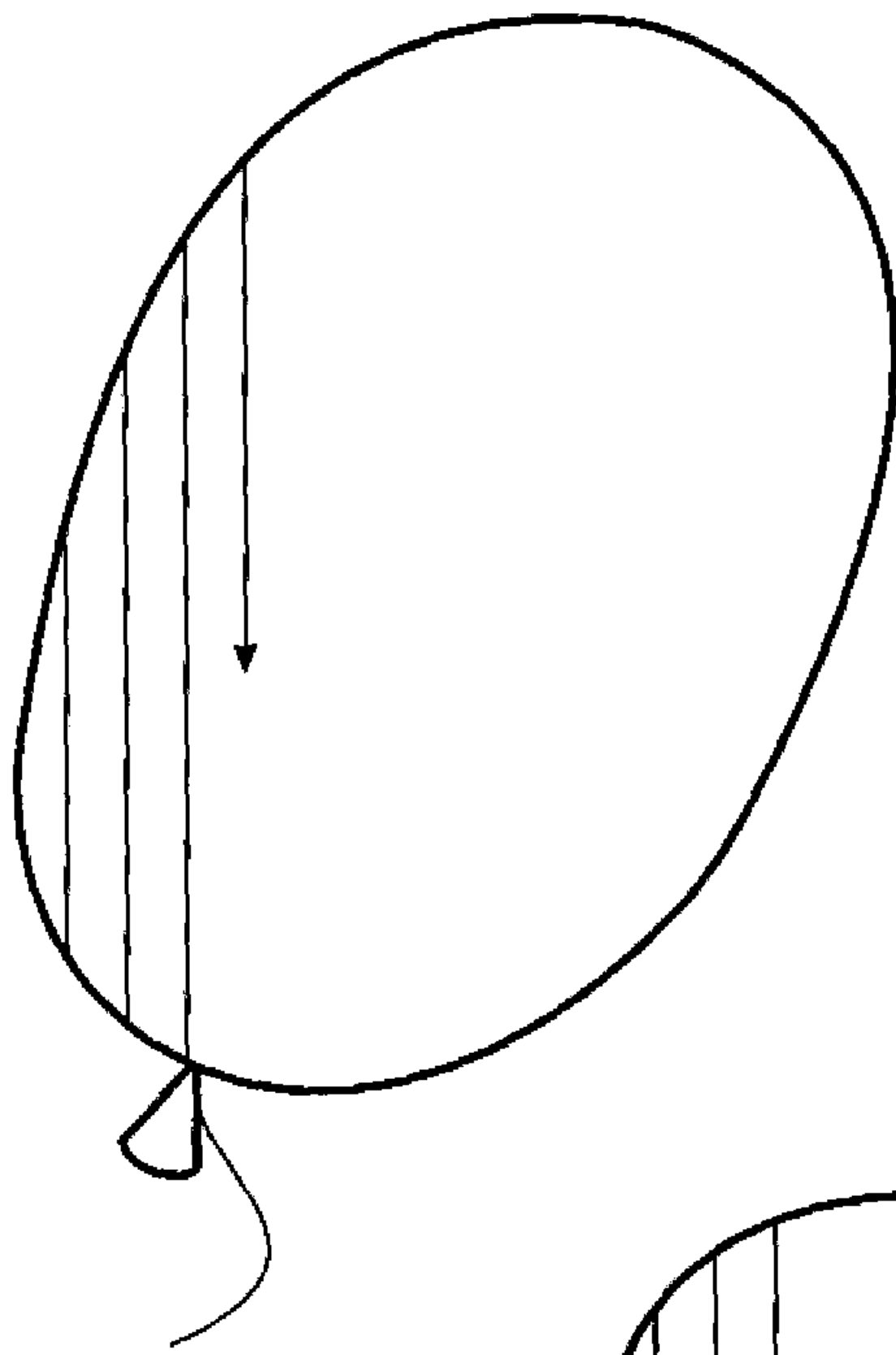
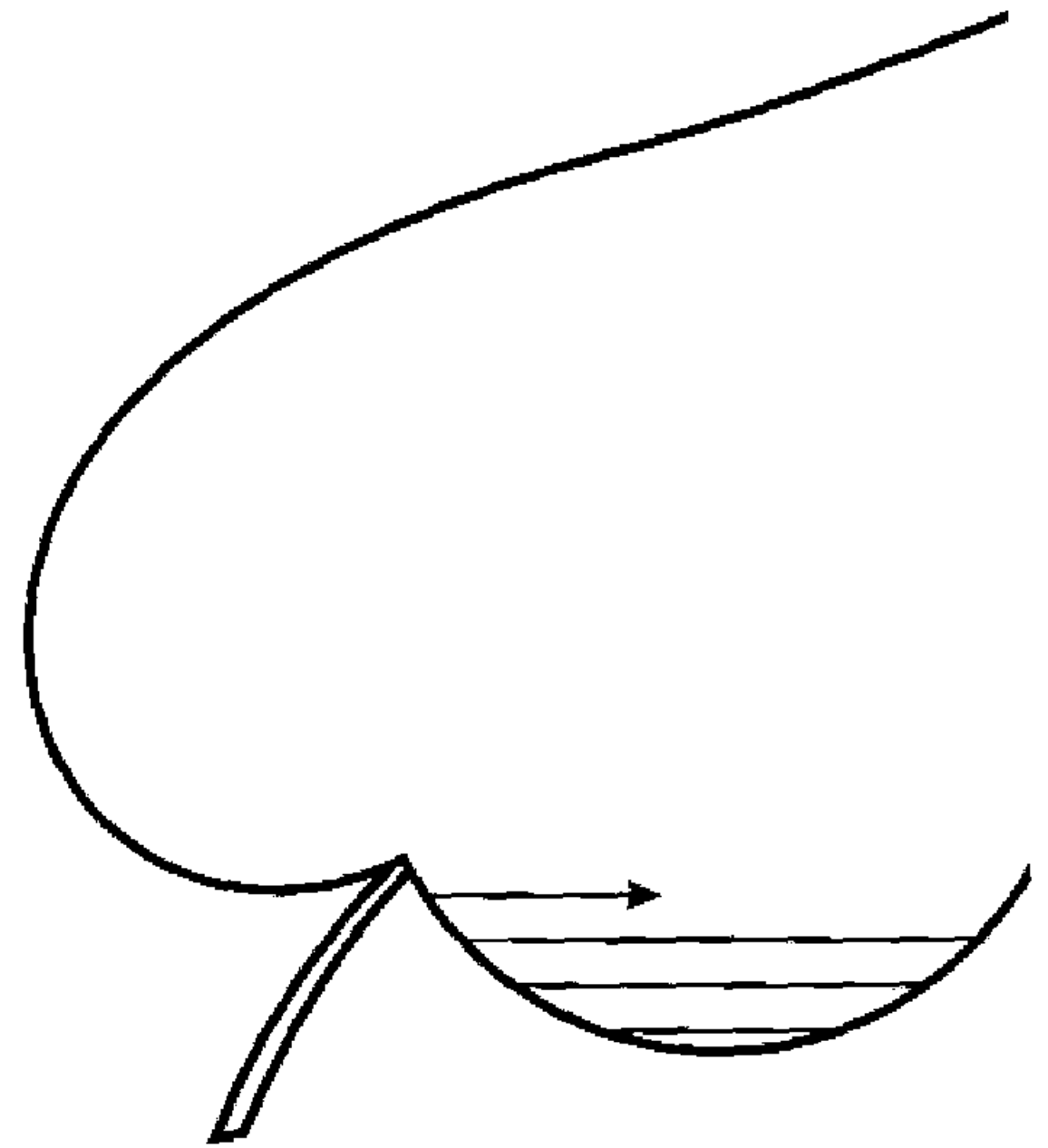
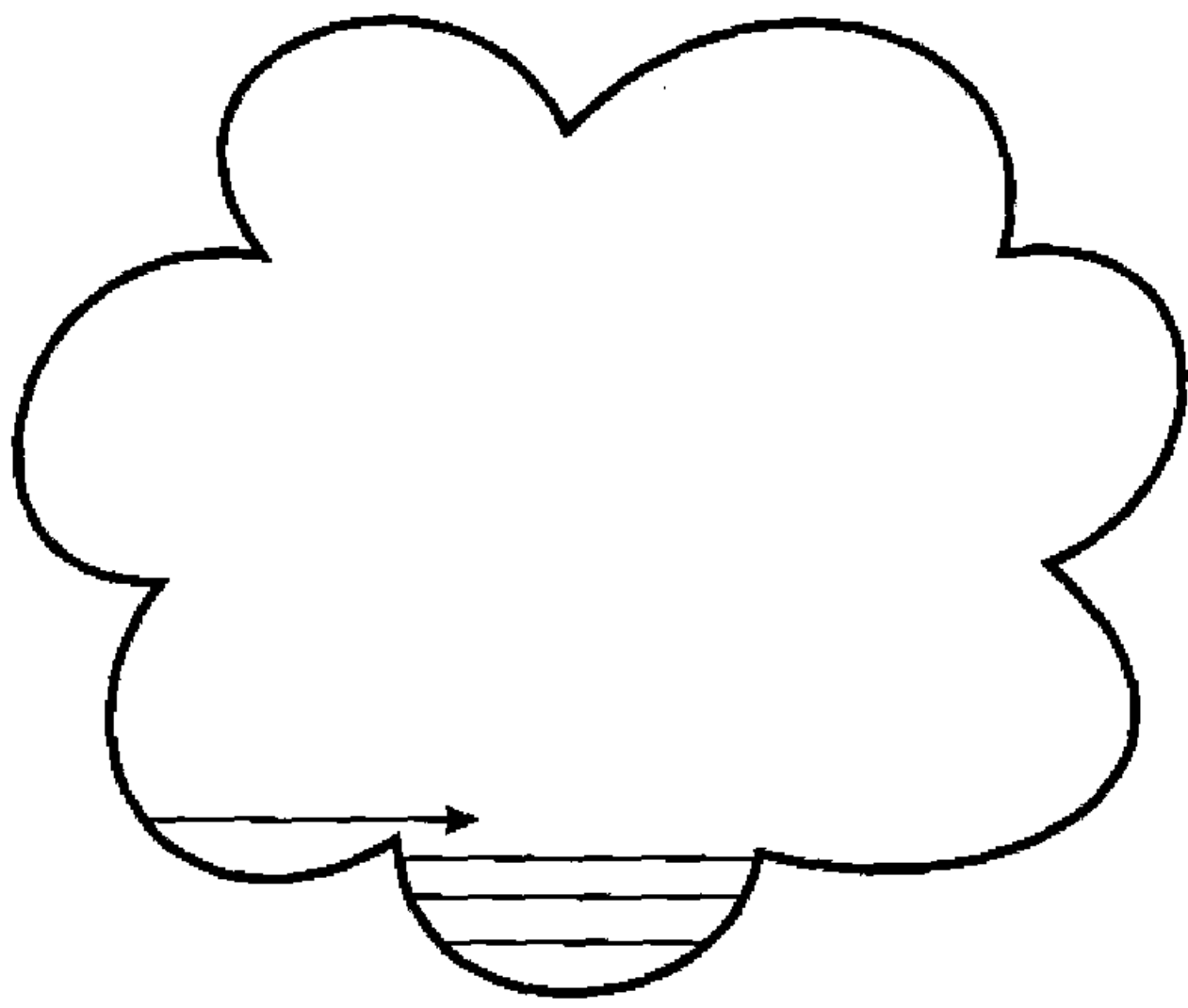

# E

EHOT

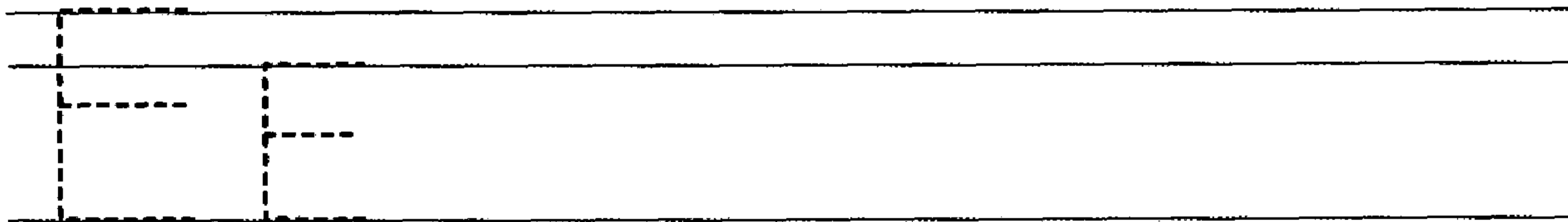
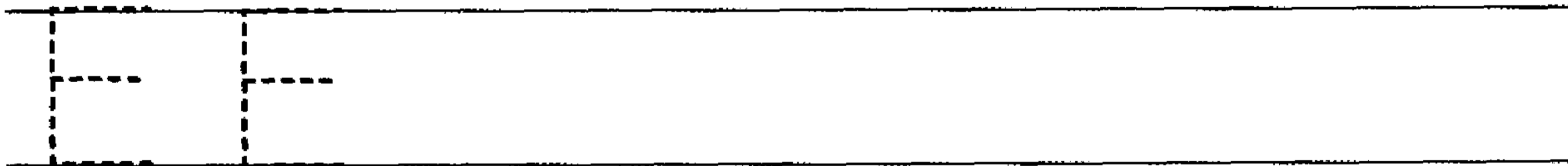
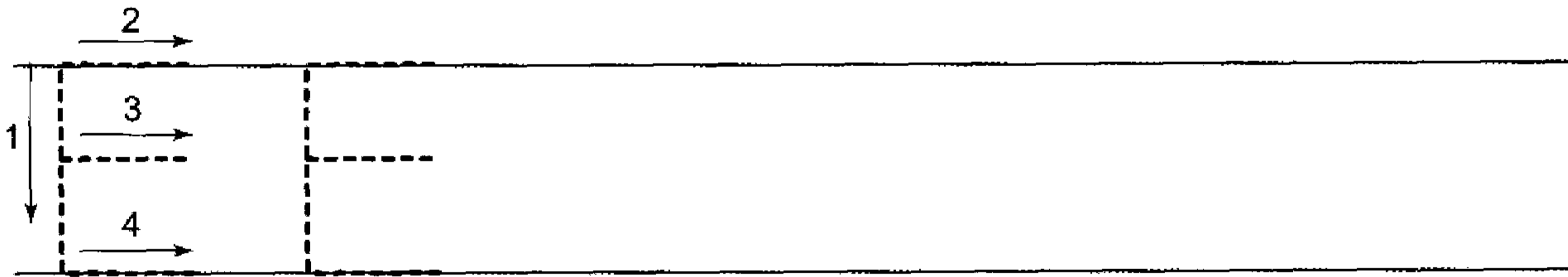

Обведи и раскрась орнаменты.

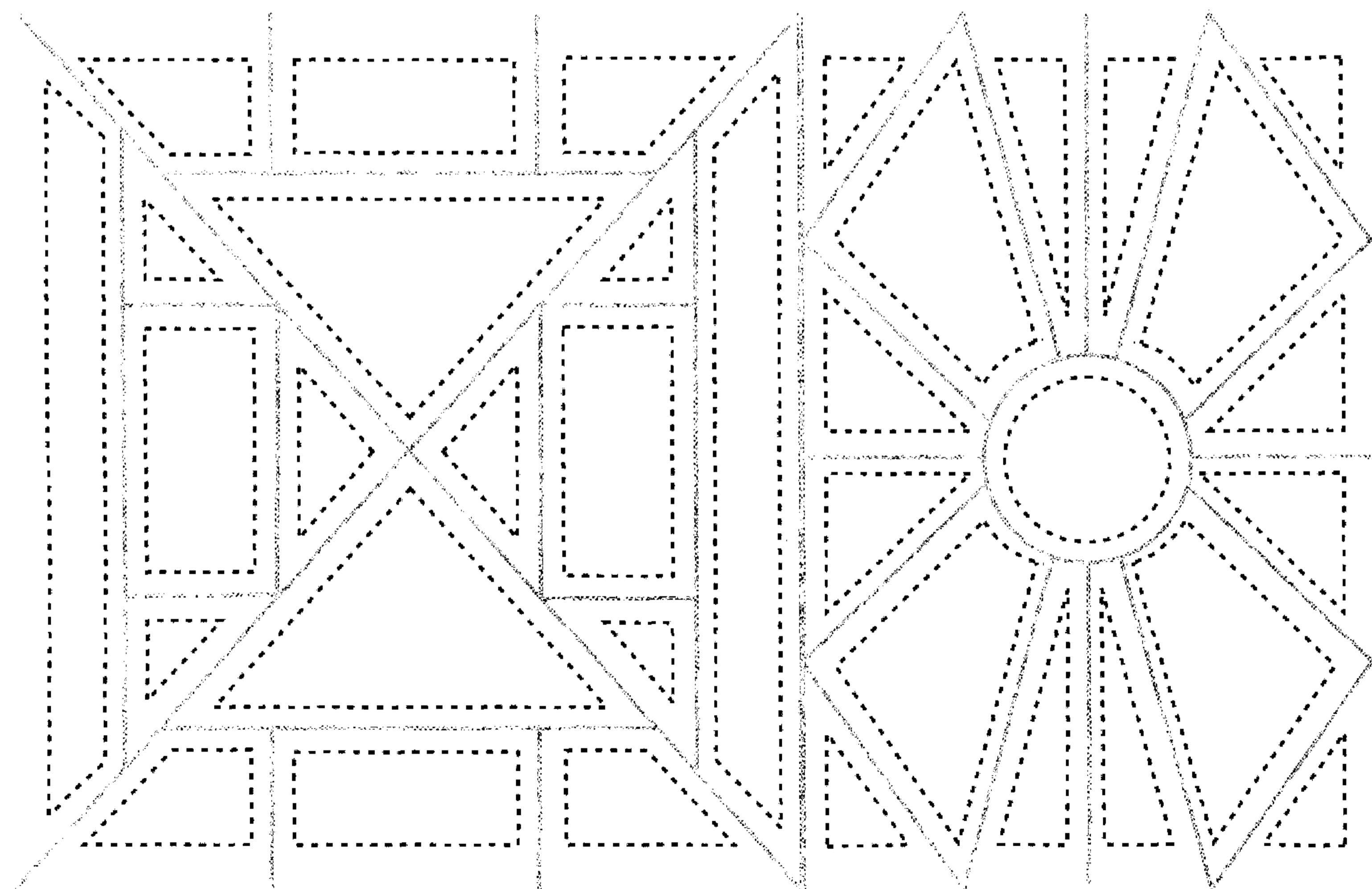
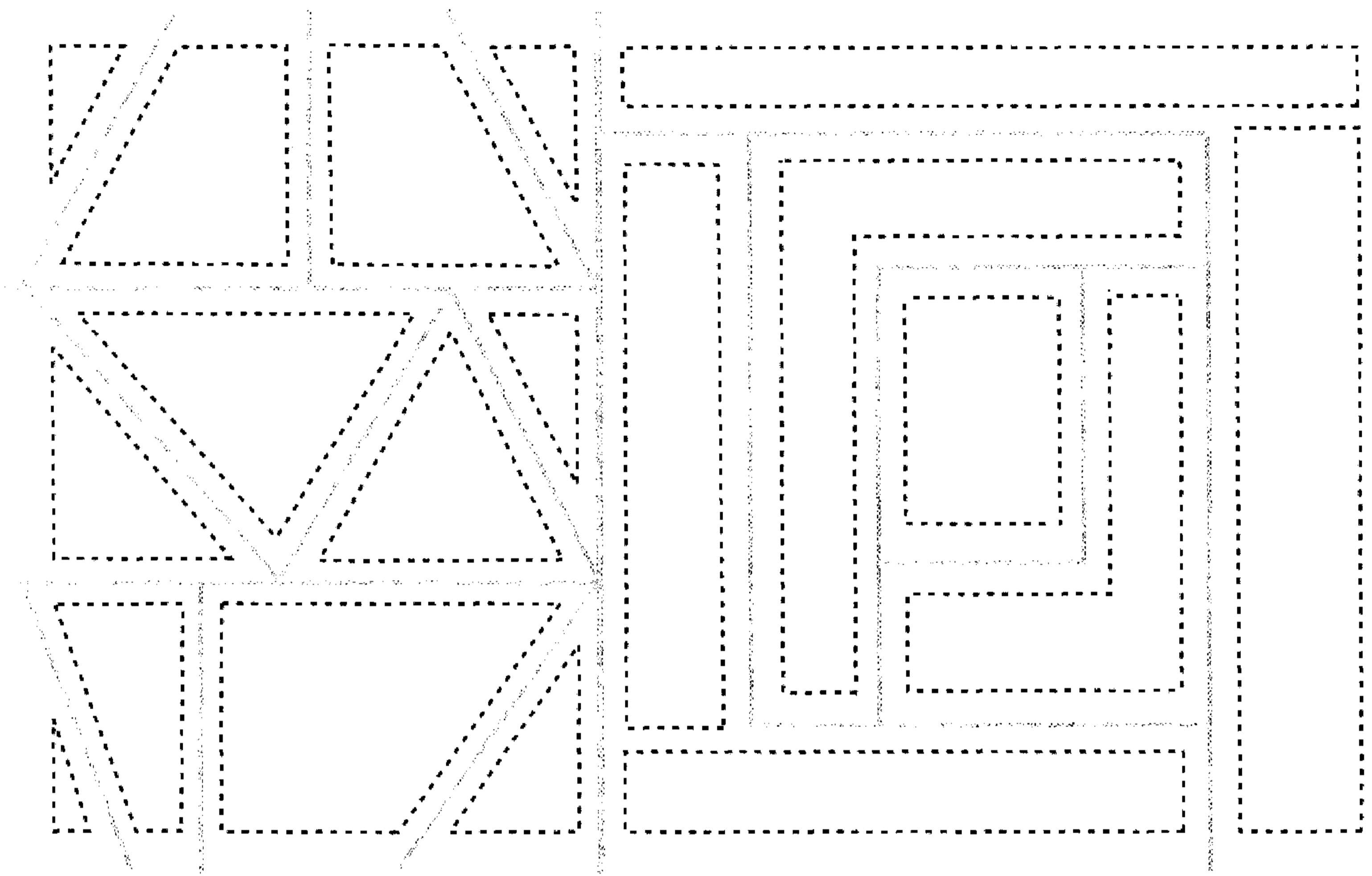

Ё

Ёж

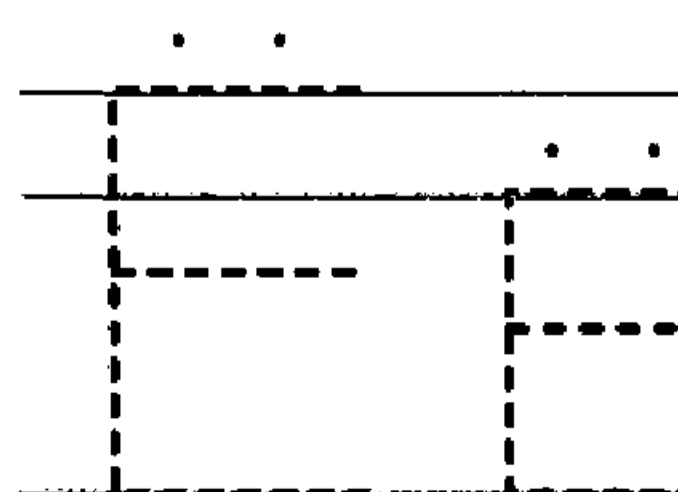
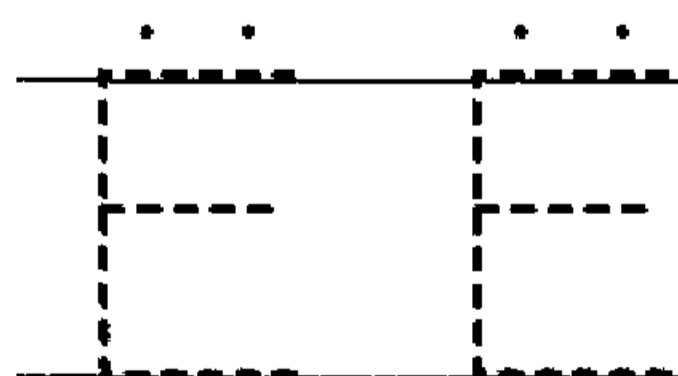
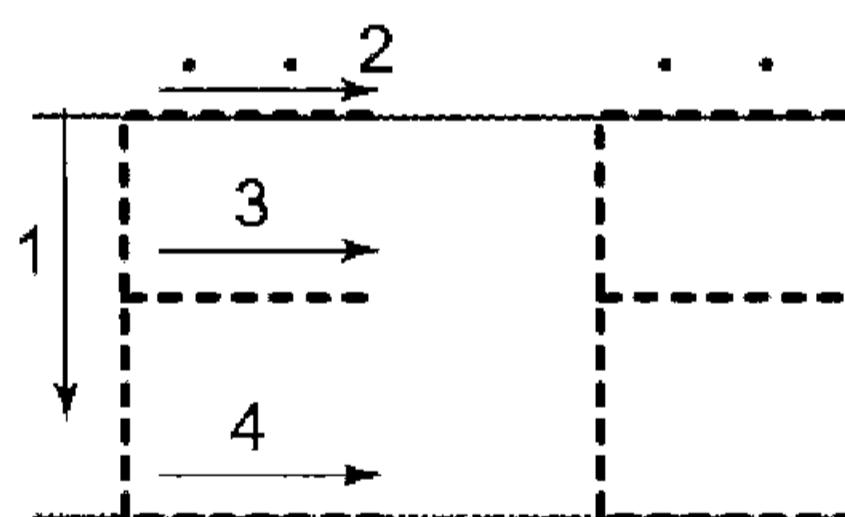

Проведи линию посередине дорожки, не отрывая карандаш от бумаги и не выходя за края дорожки. Раскрась дорожку.

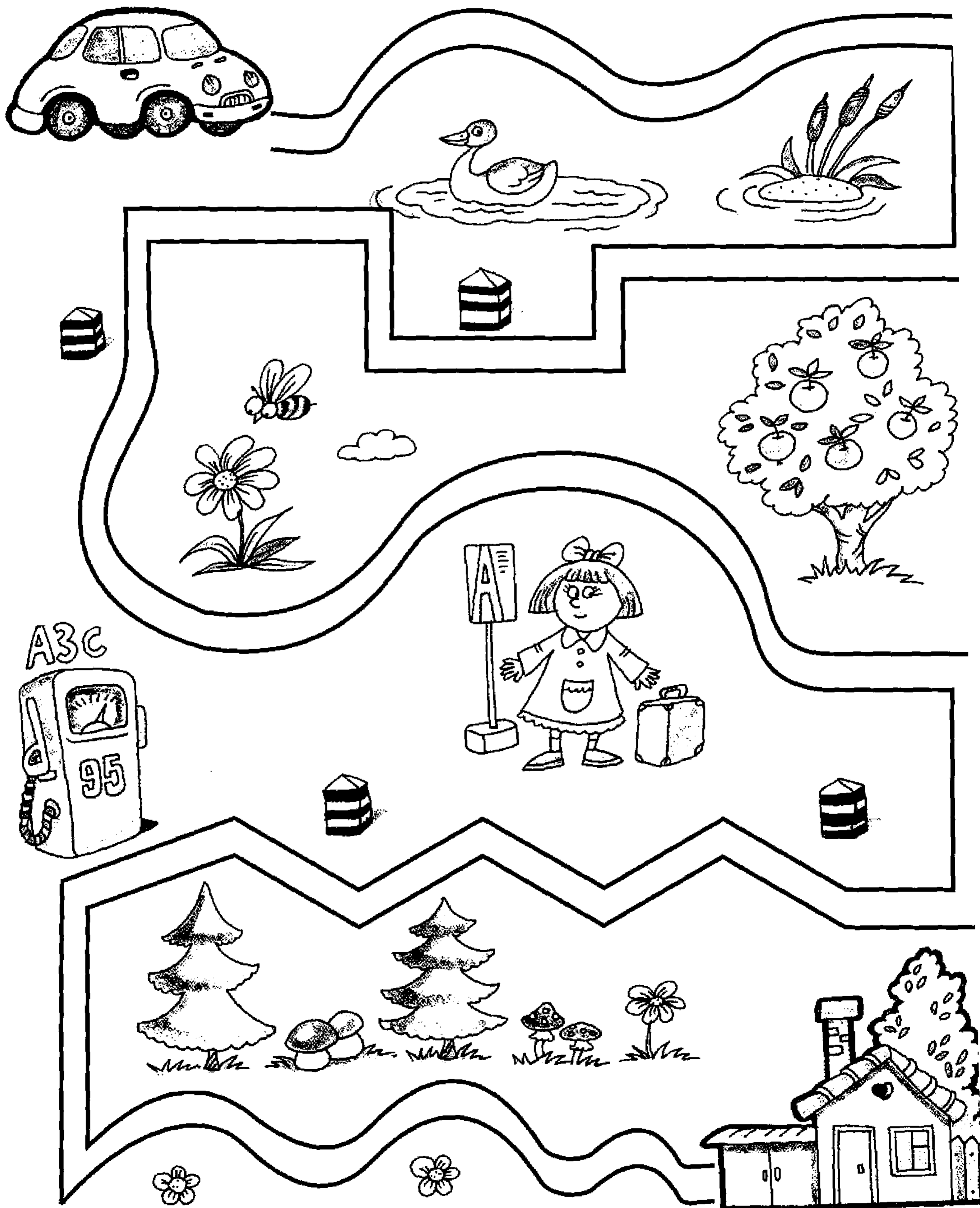



ЖЖ

Жираф

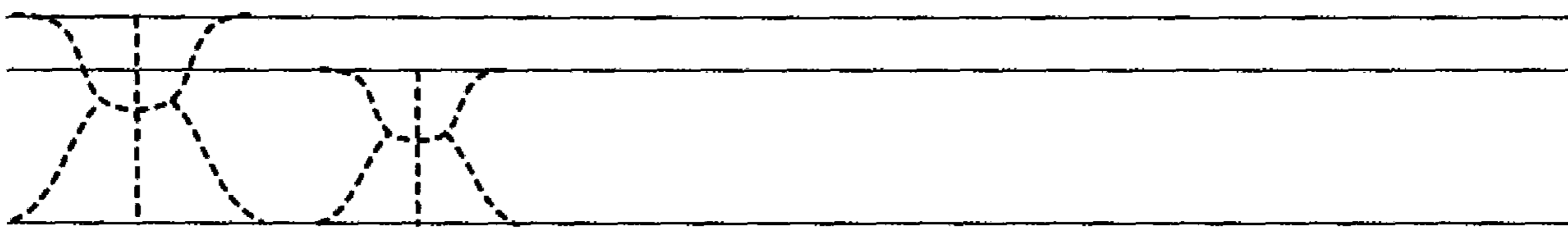
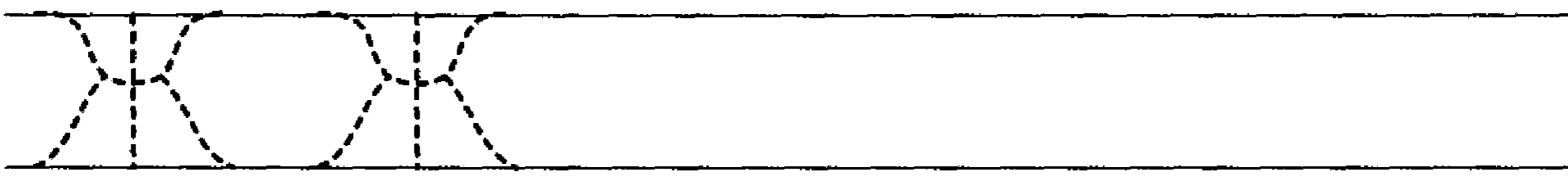
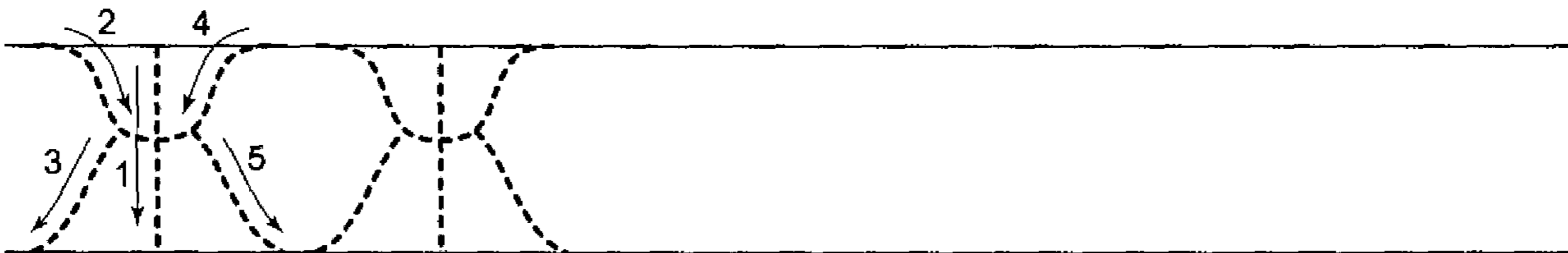
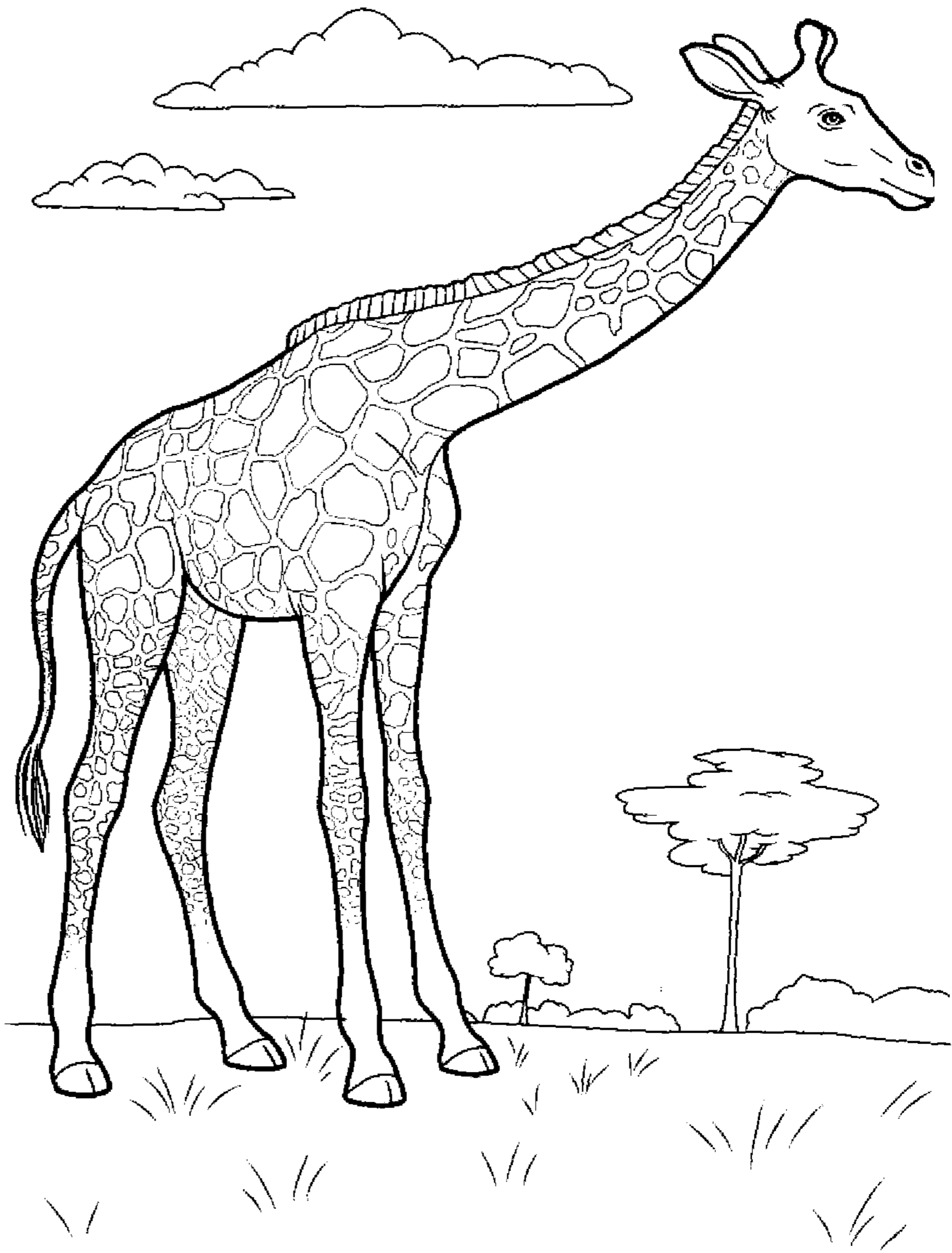

.....  
Дорисуй картинку. Соедини линии по точкам и раскрась.  
.....

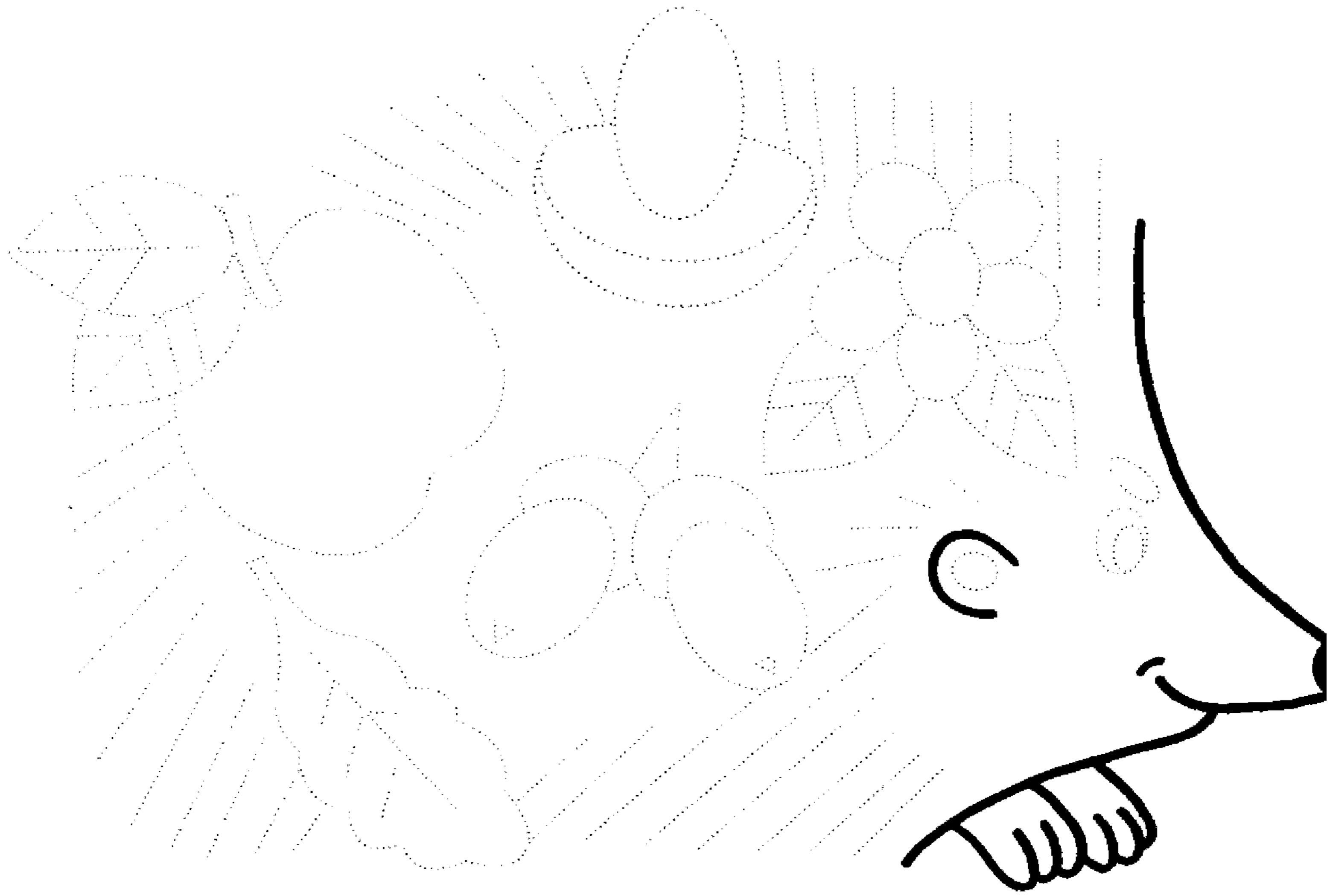

.....  
Выполни штриховку прямыми линиями, не выходя за контур рисунка, и раскрась.  
.....

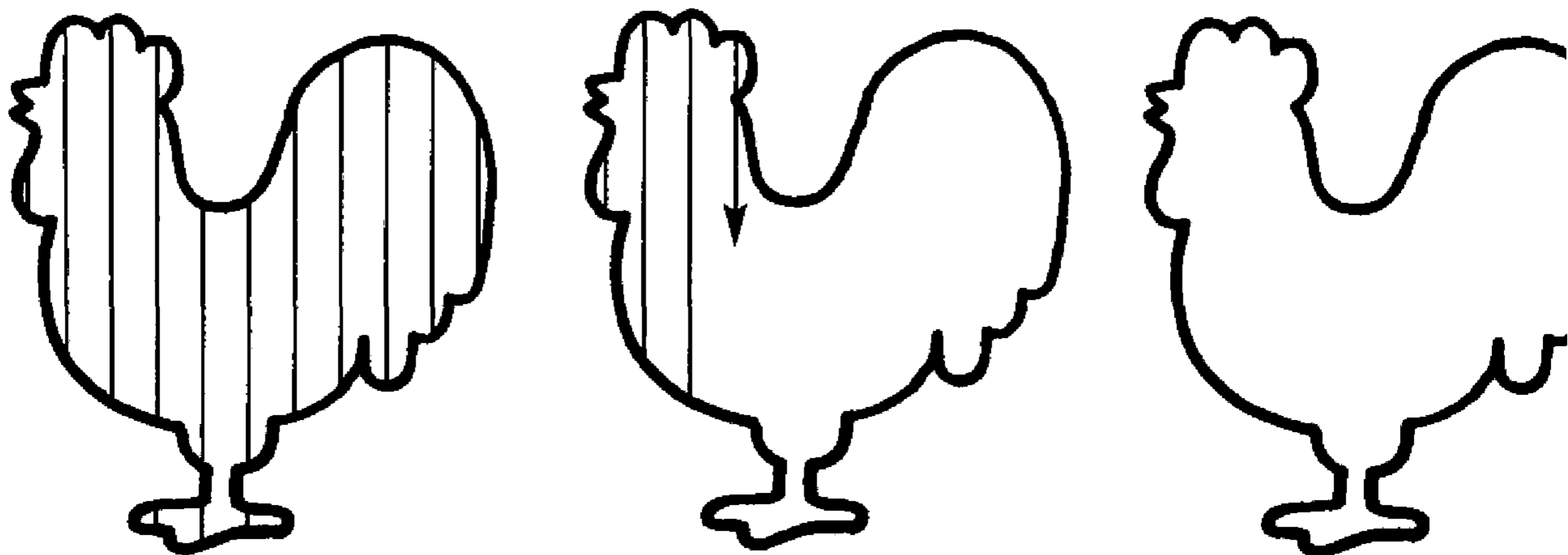

# З

Заяц

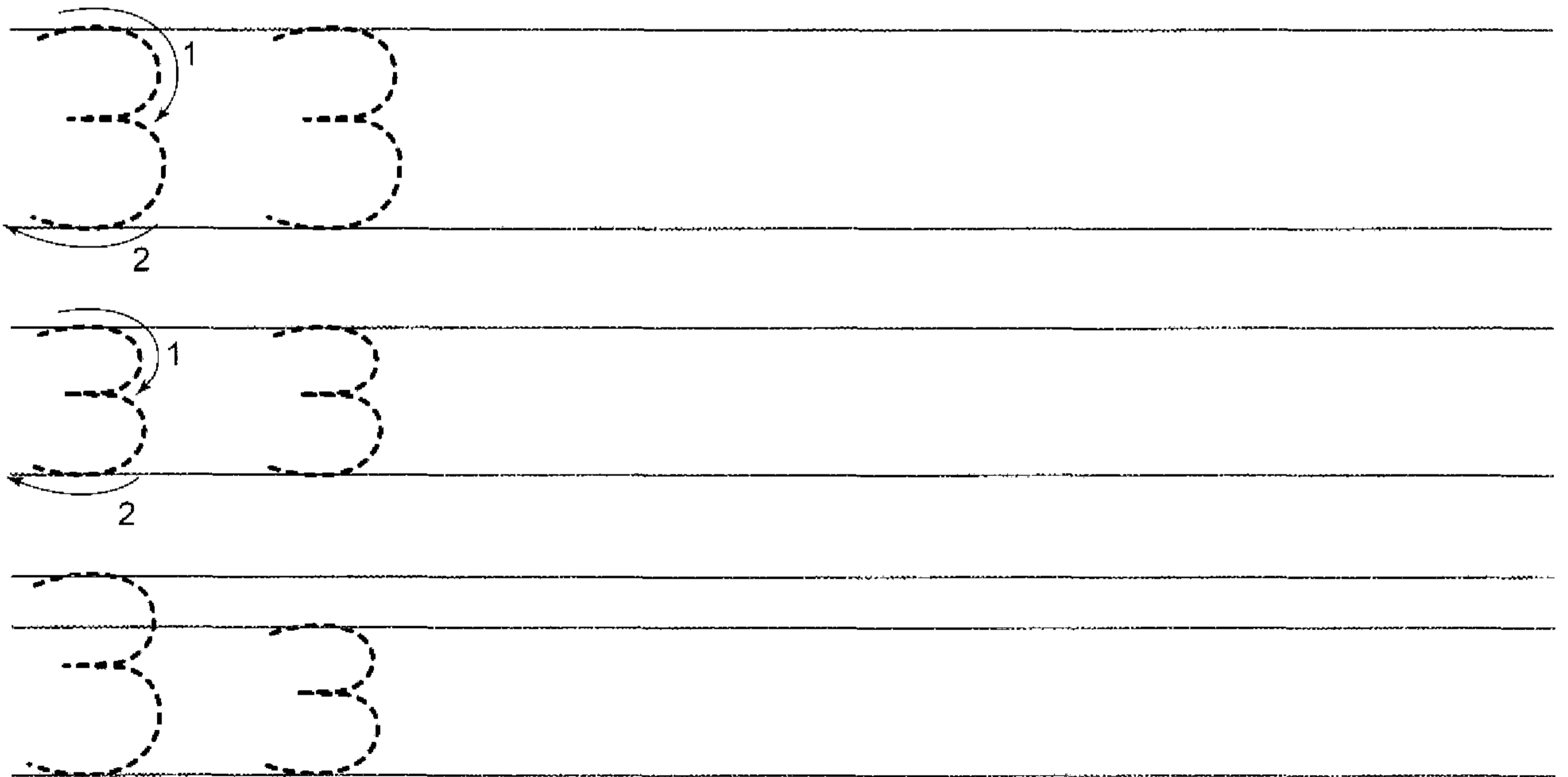
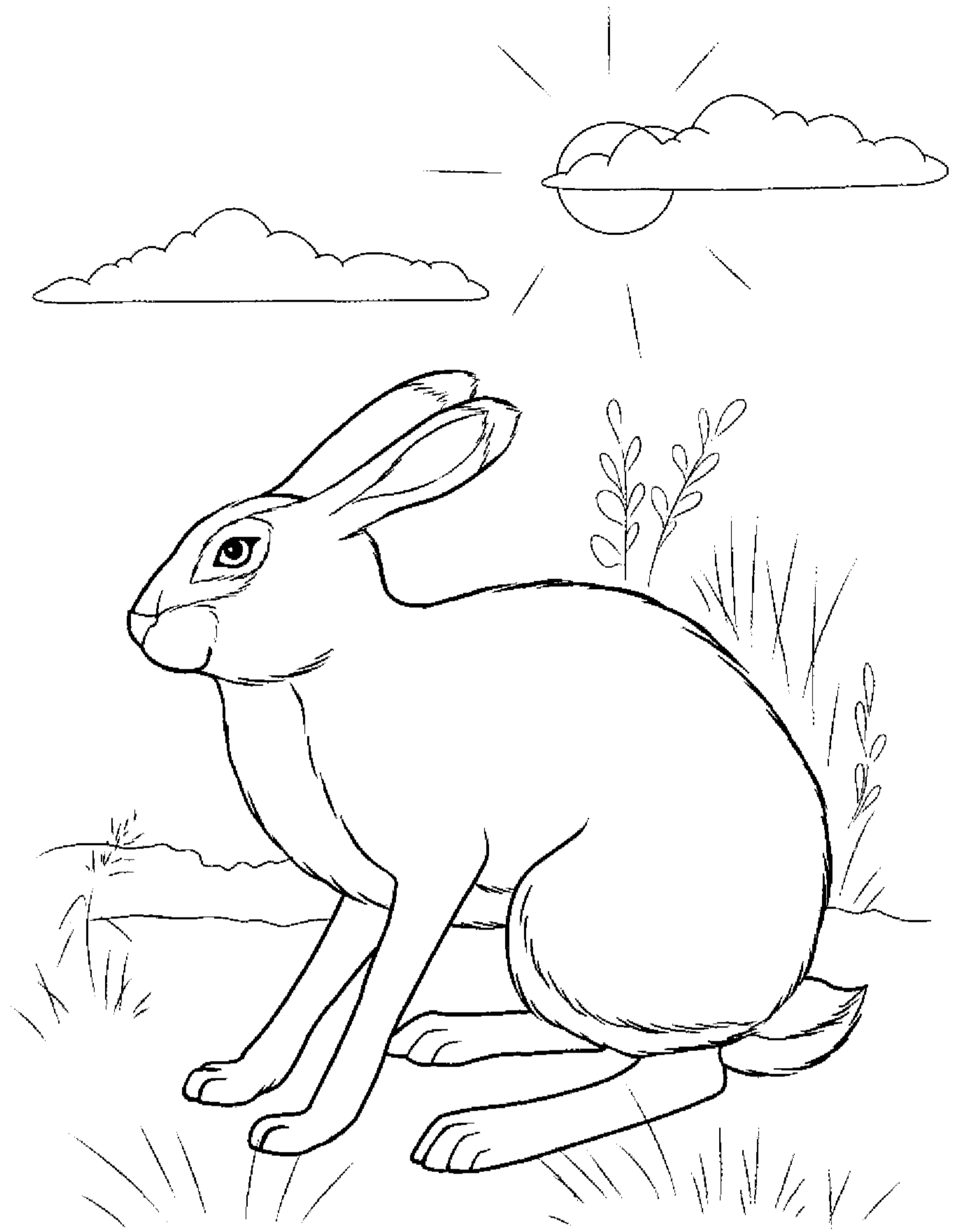

Обведи картинки по пунктирным линиям и раскрась их.

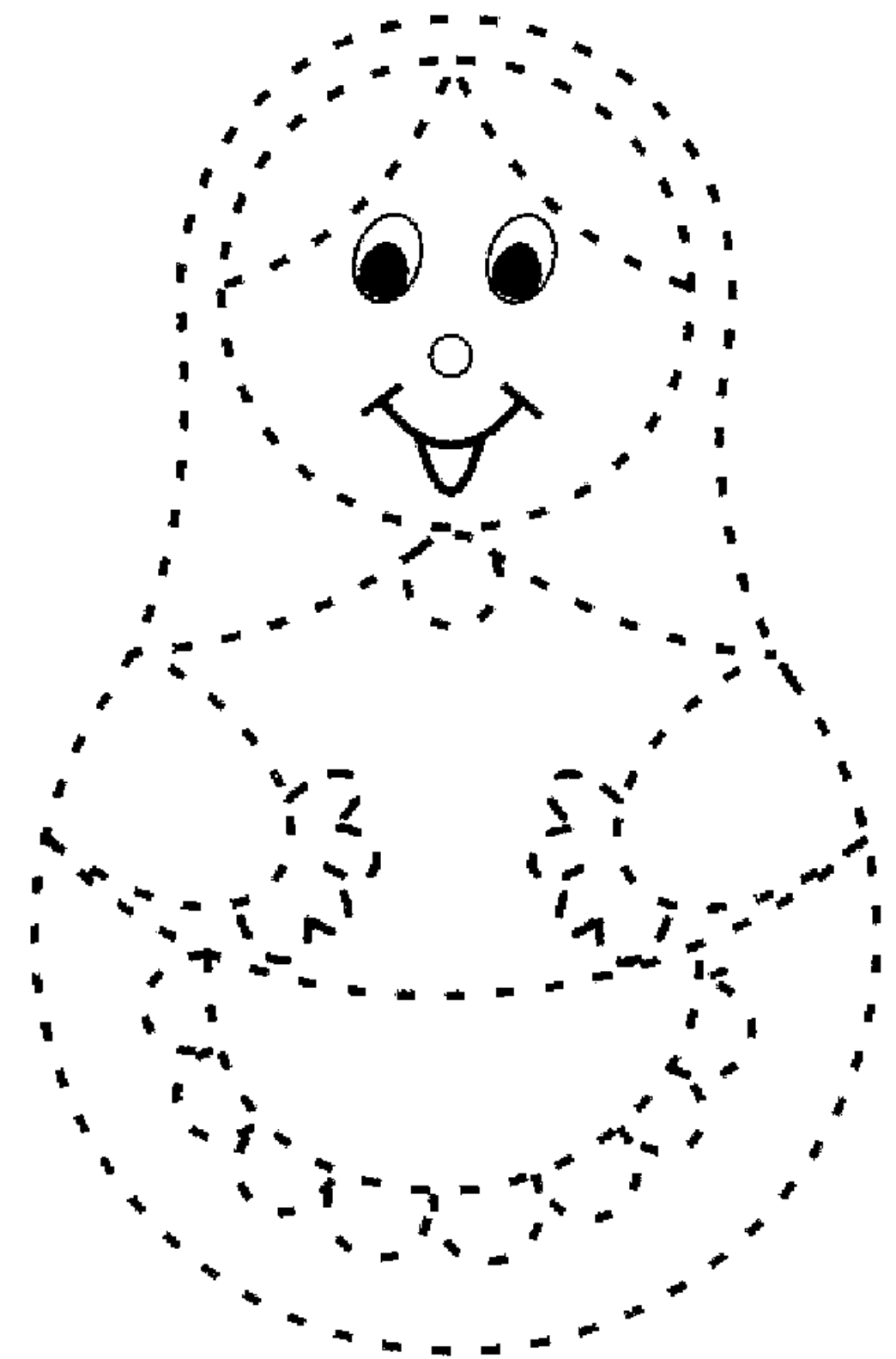
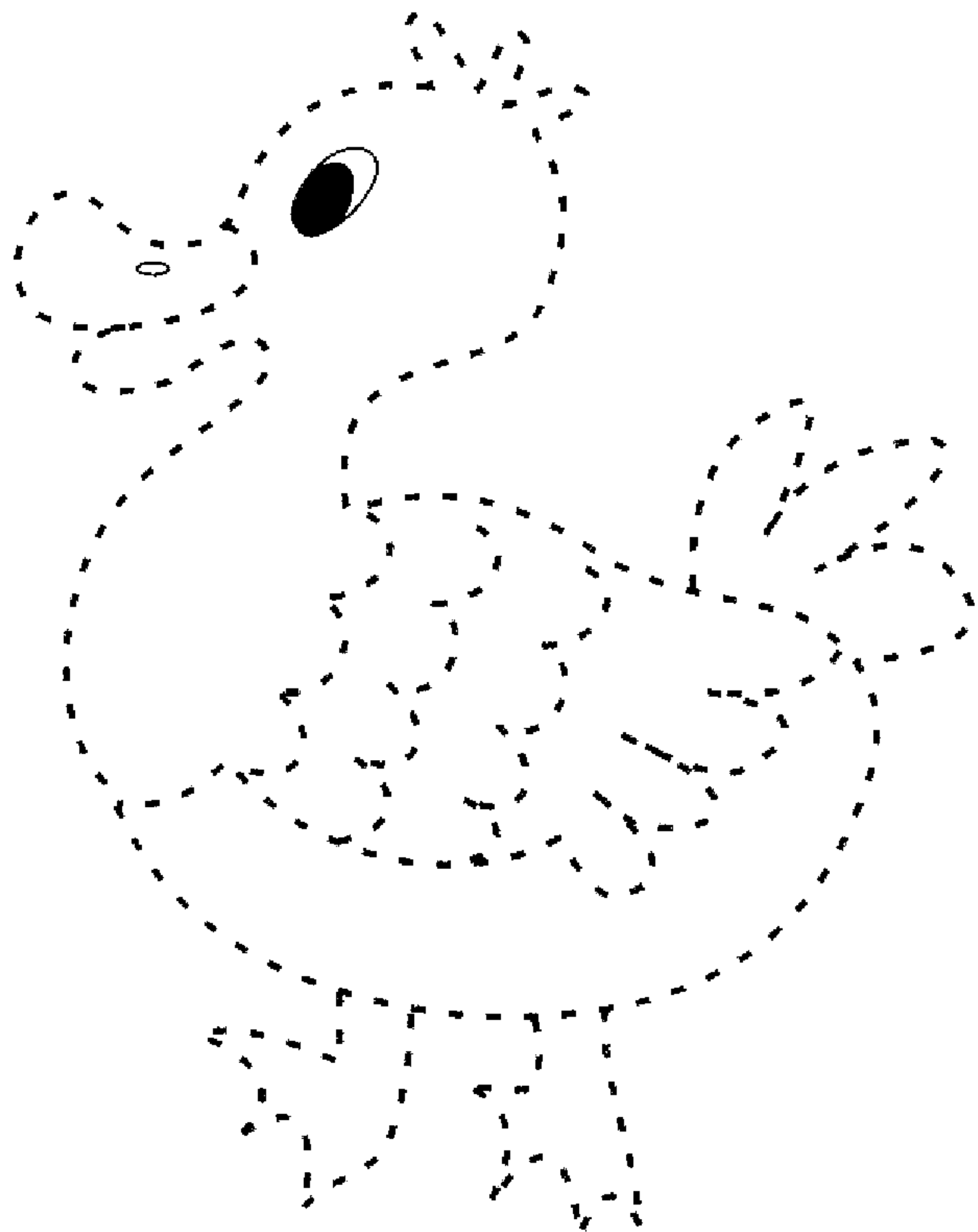
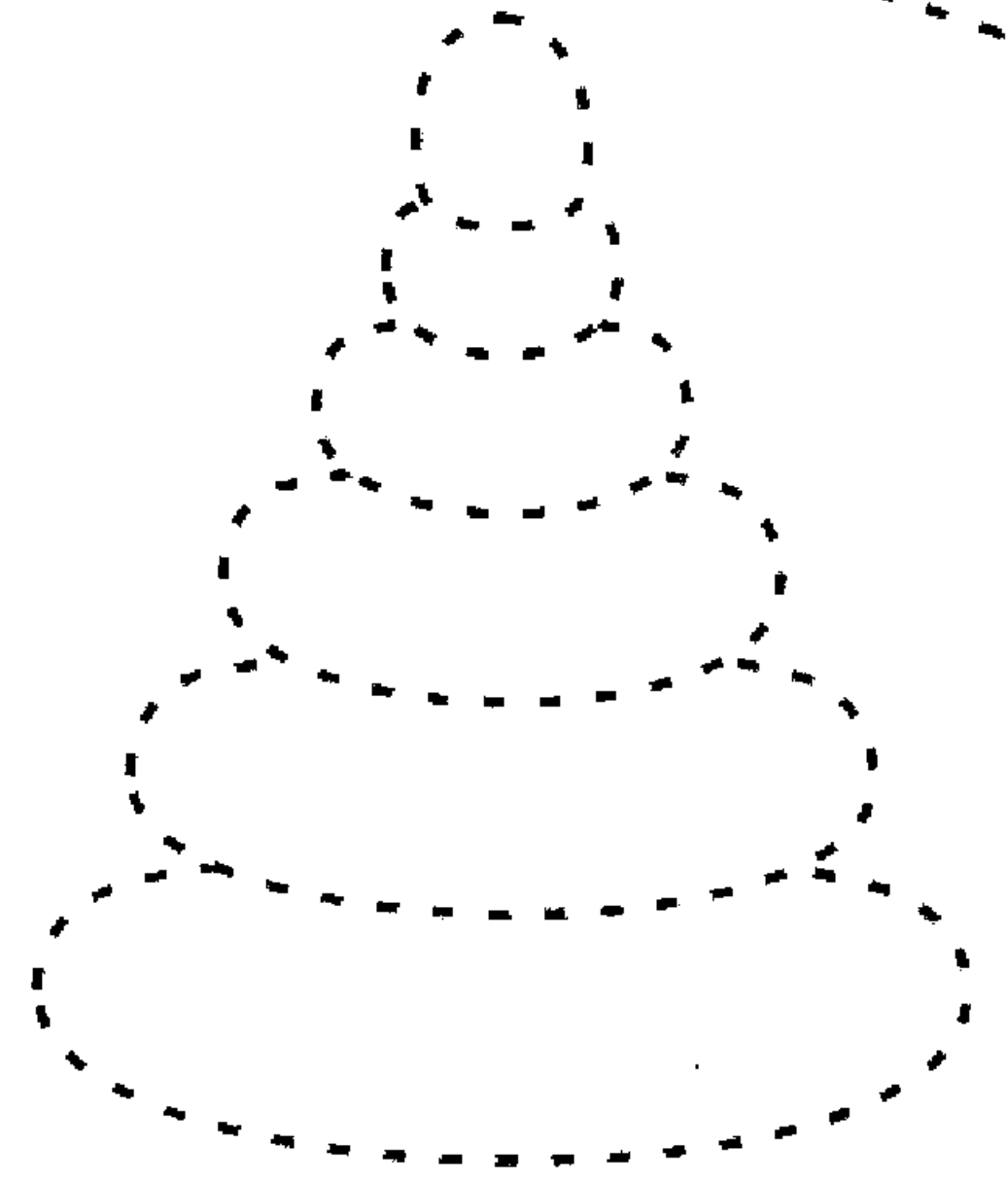
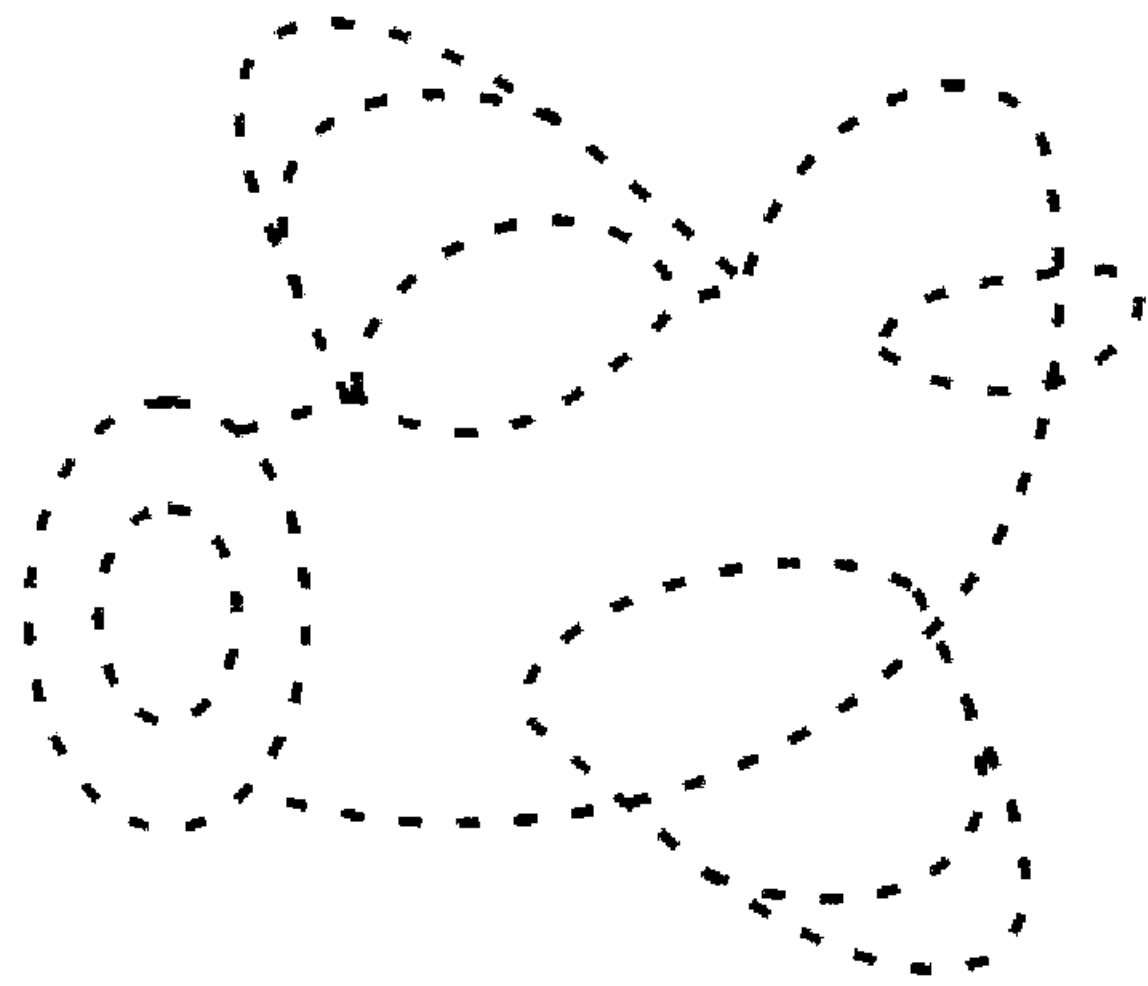
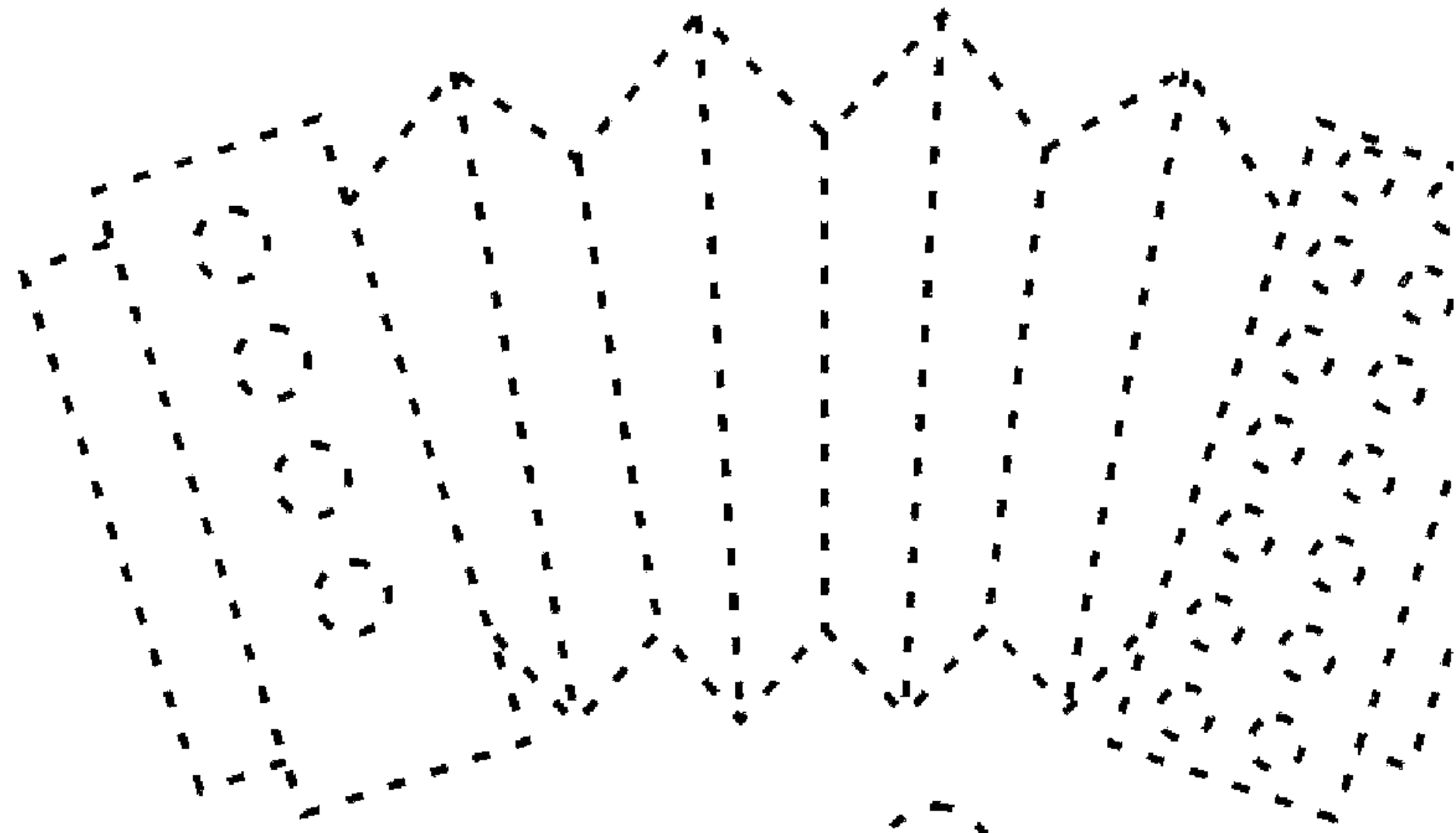
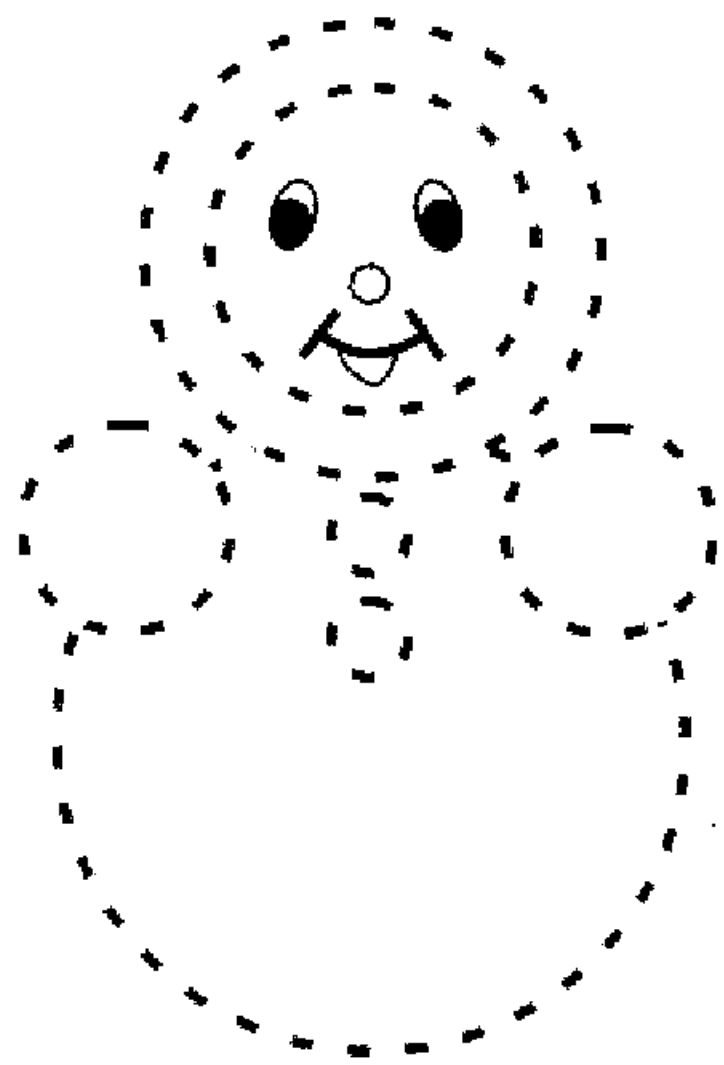

# И

Индюк

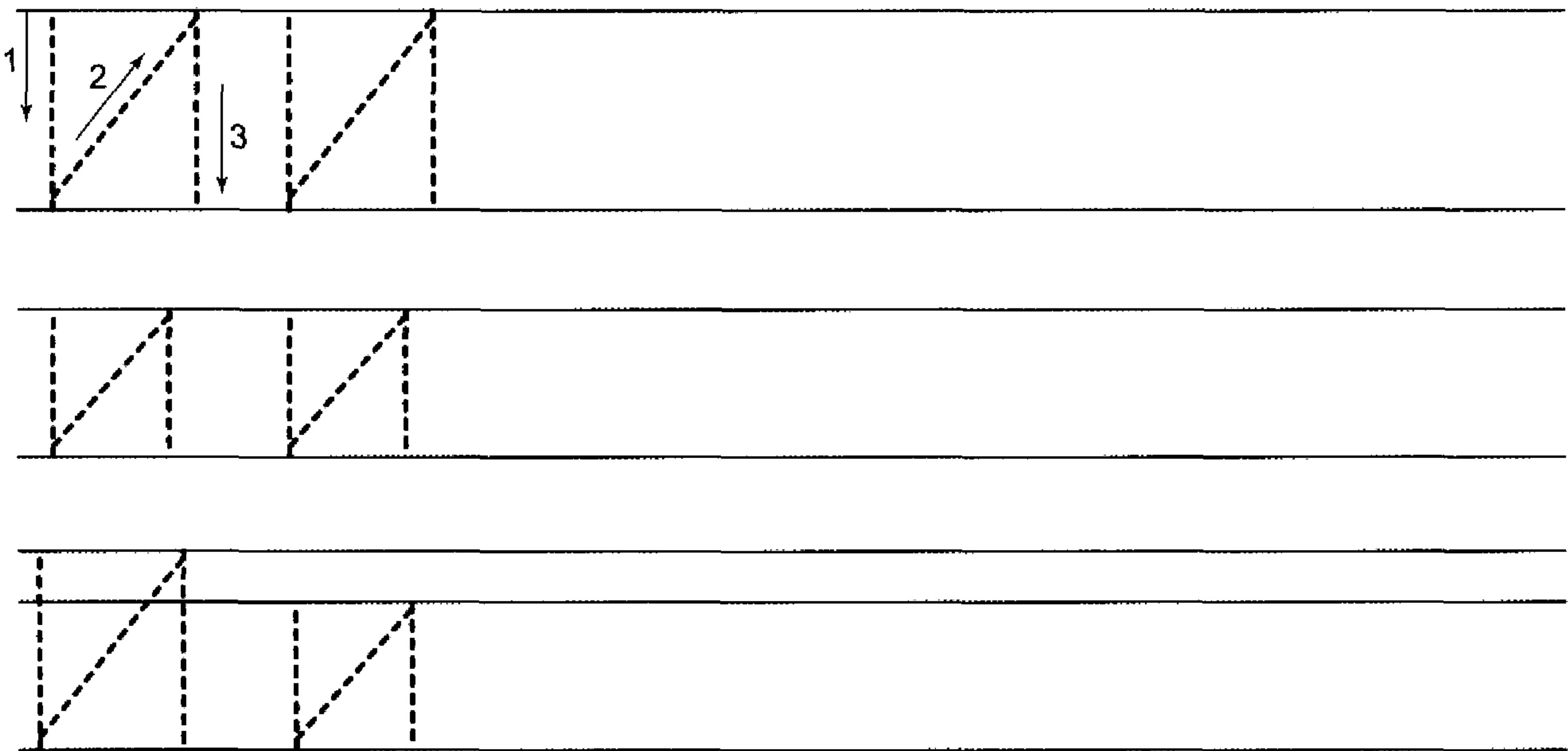
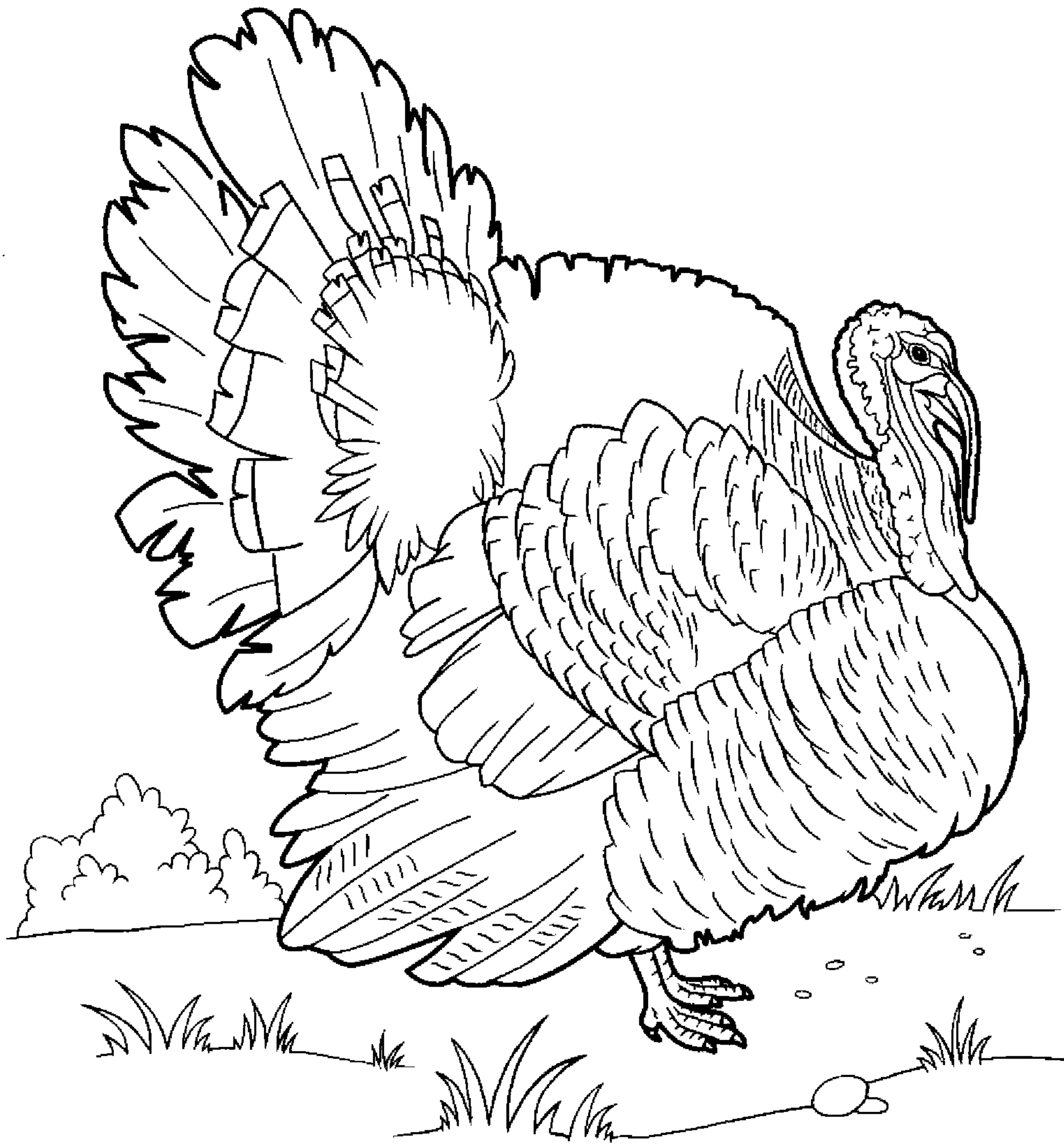

Дорисуй по точкам и раскрась.

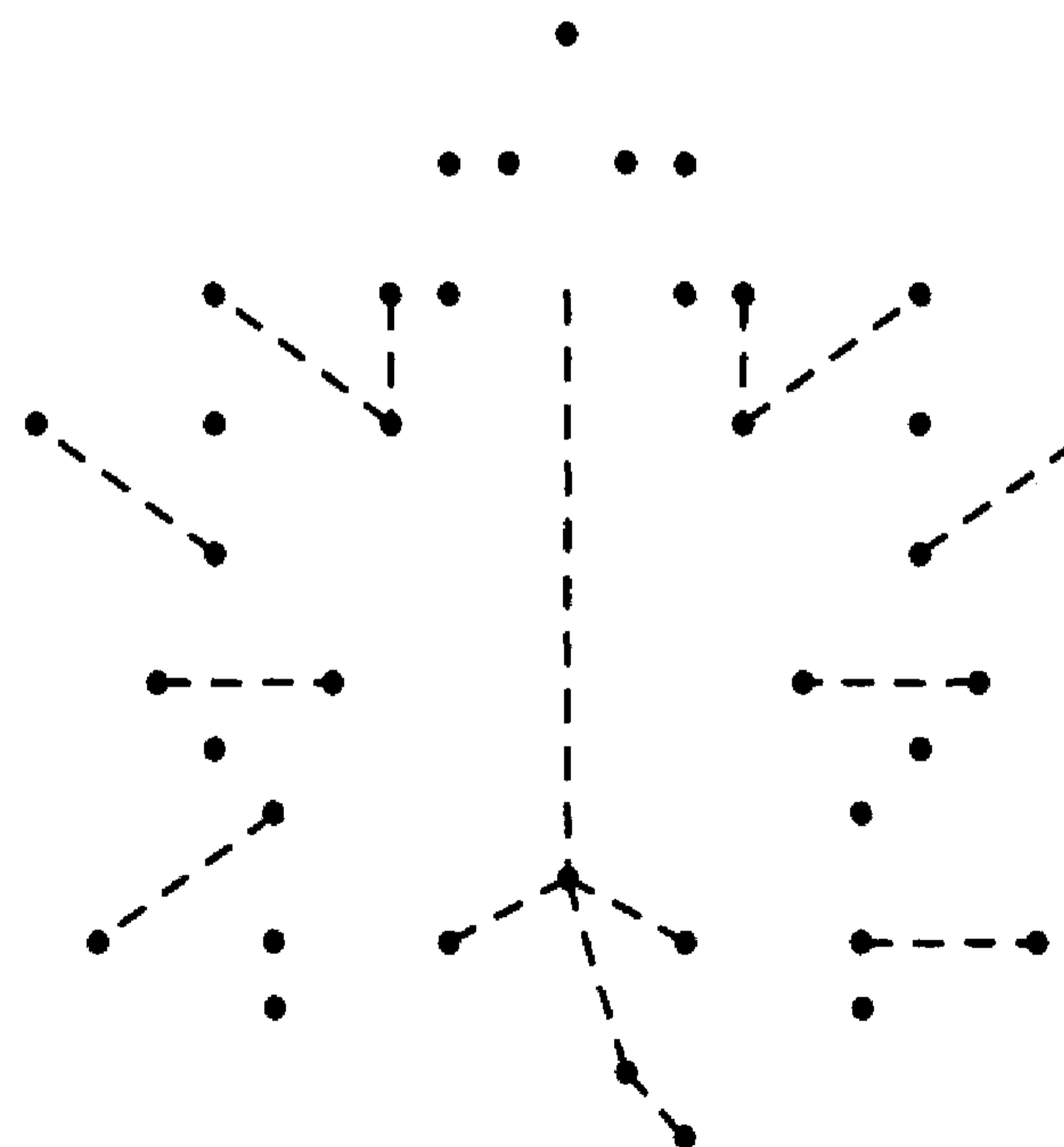
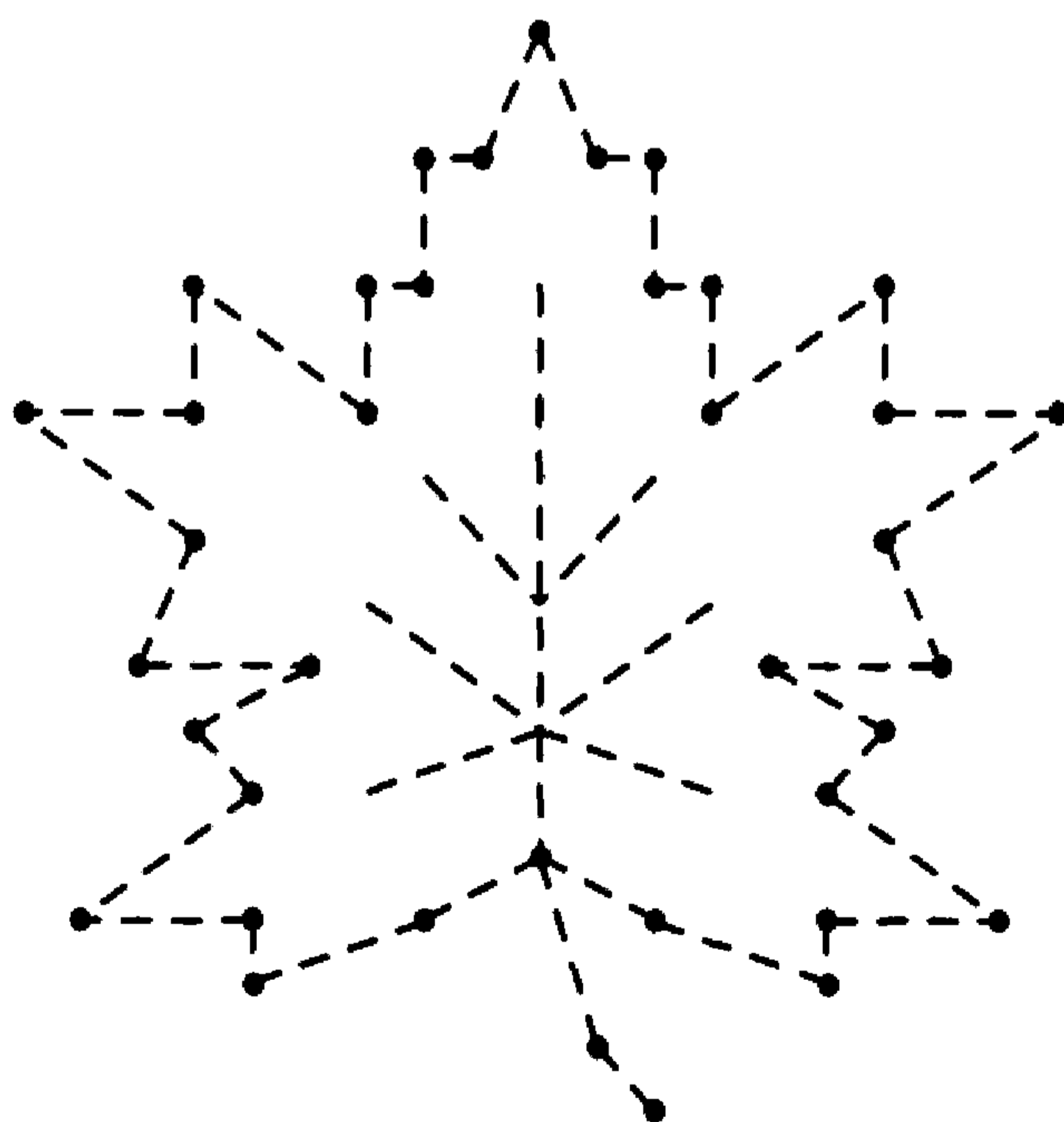
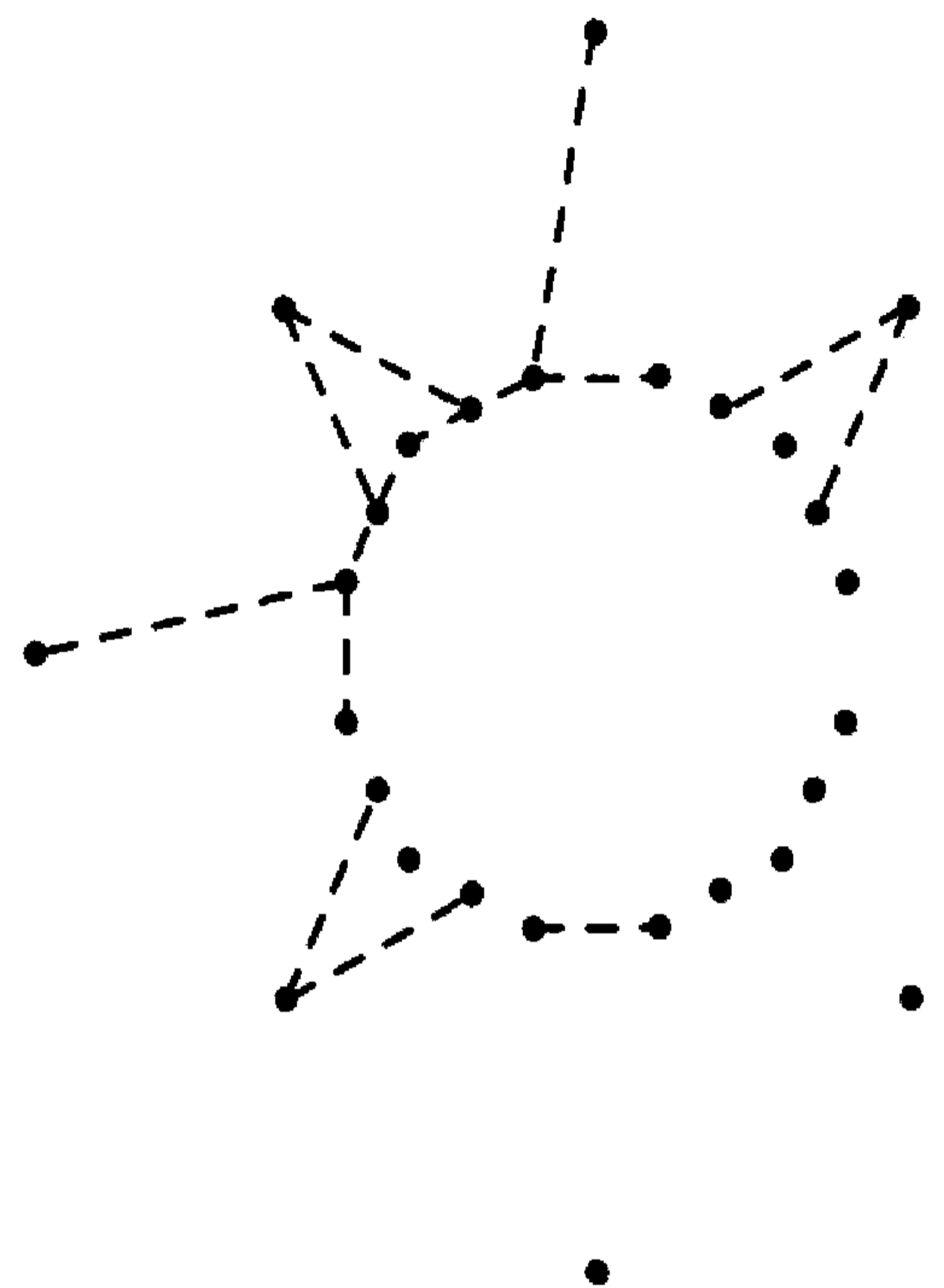
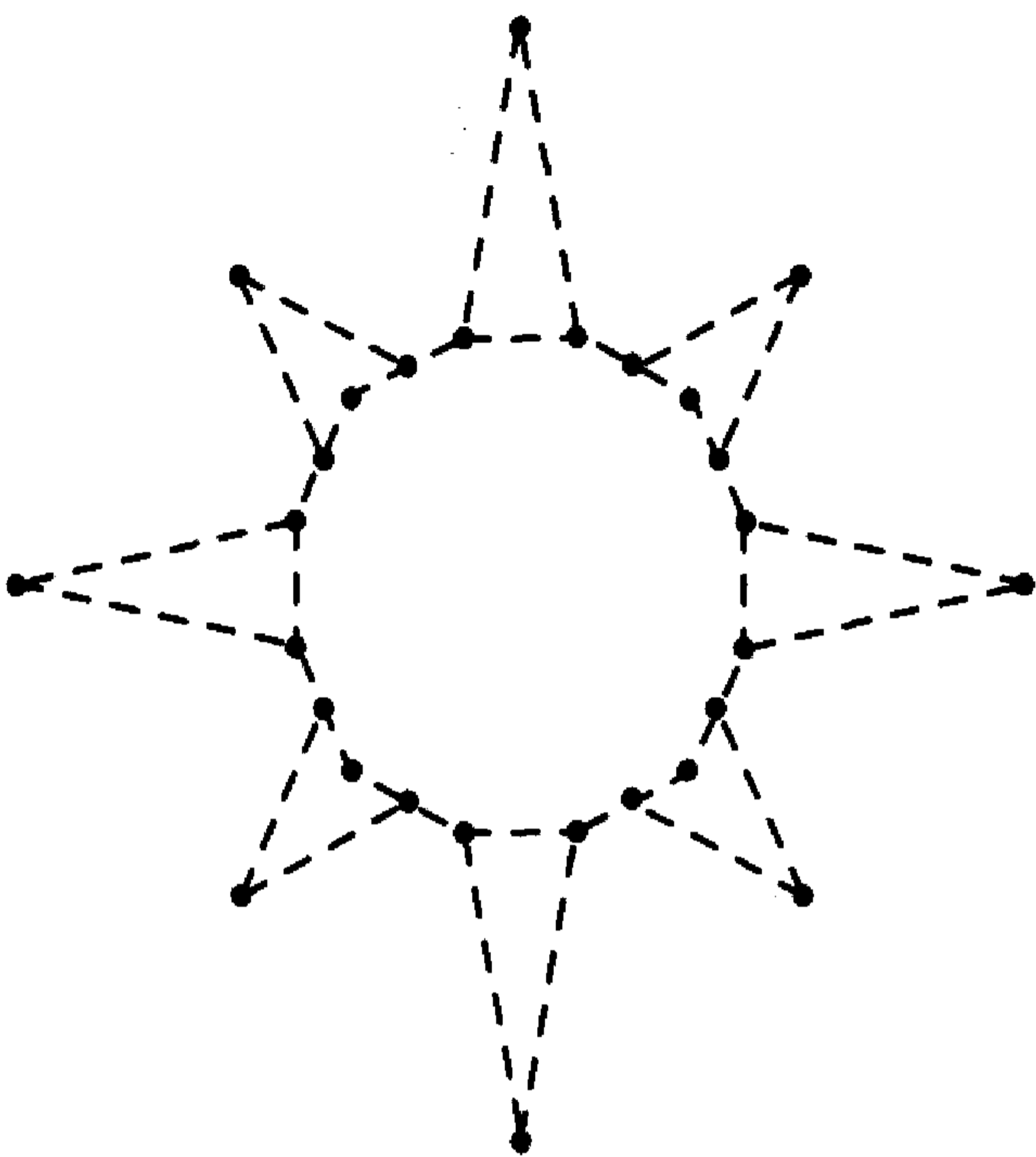

# Й

Койот

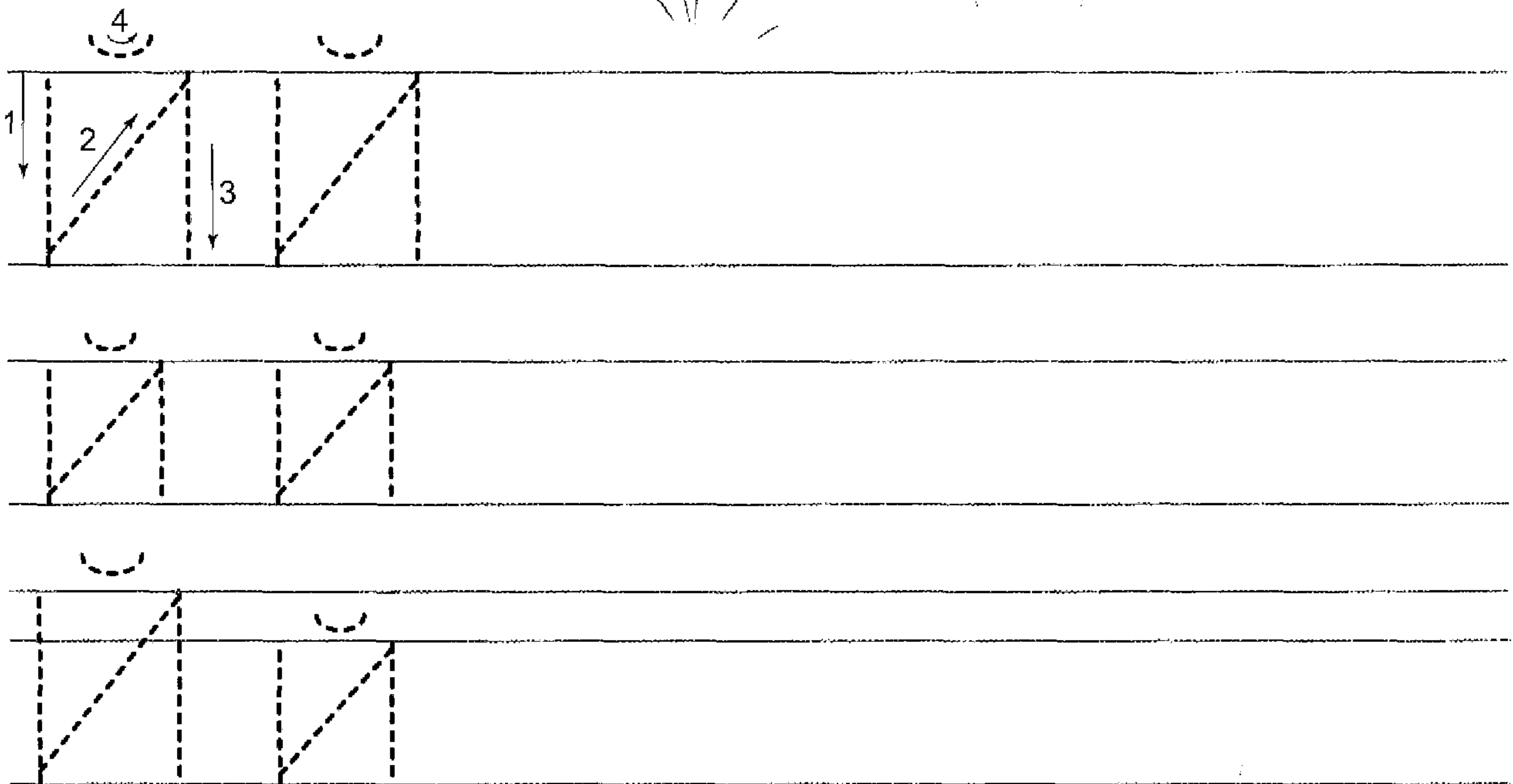
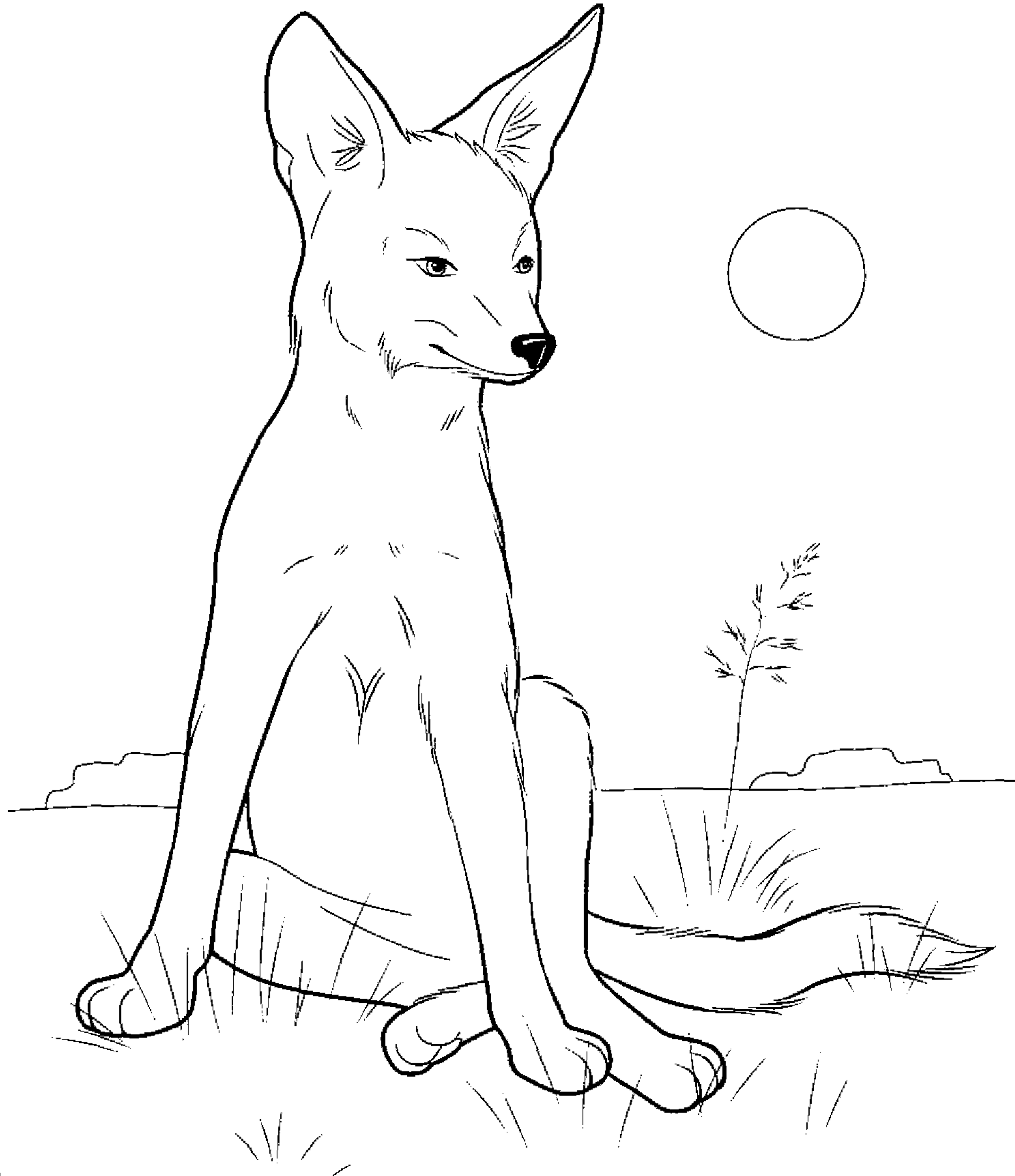

Обведи рисунки по пунктирным линиям и раскрась.

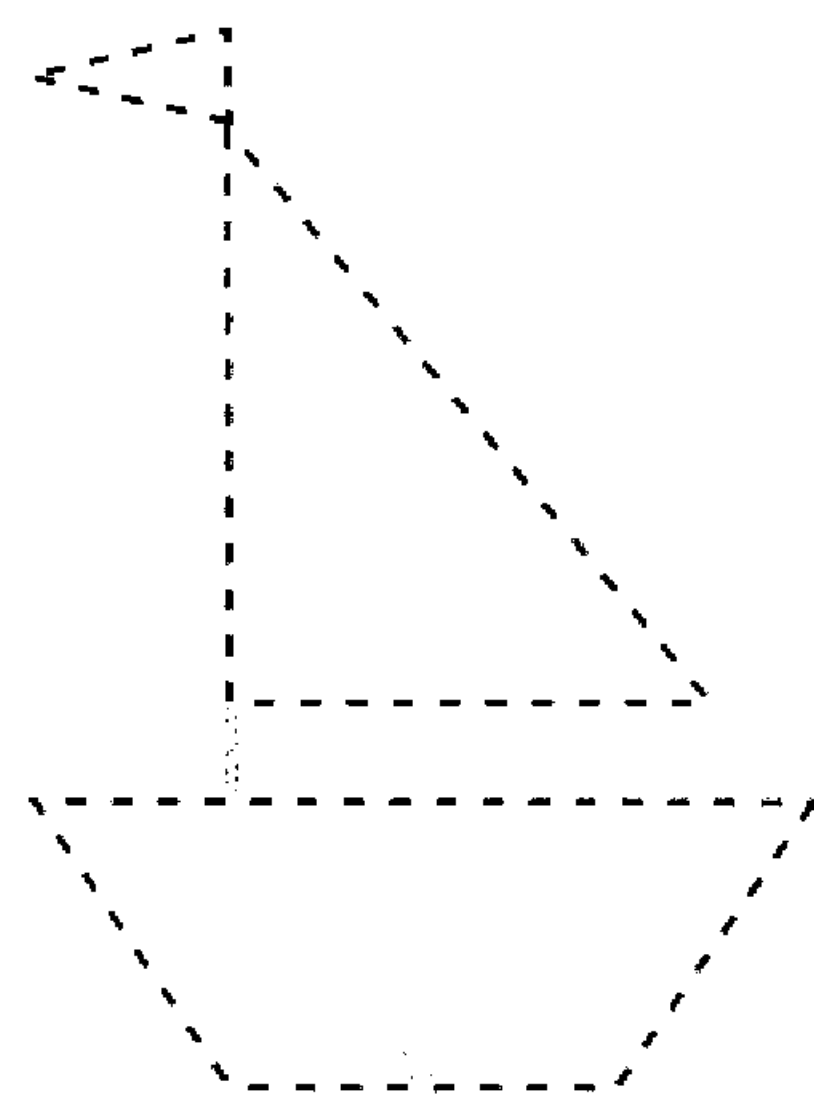
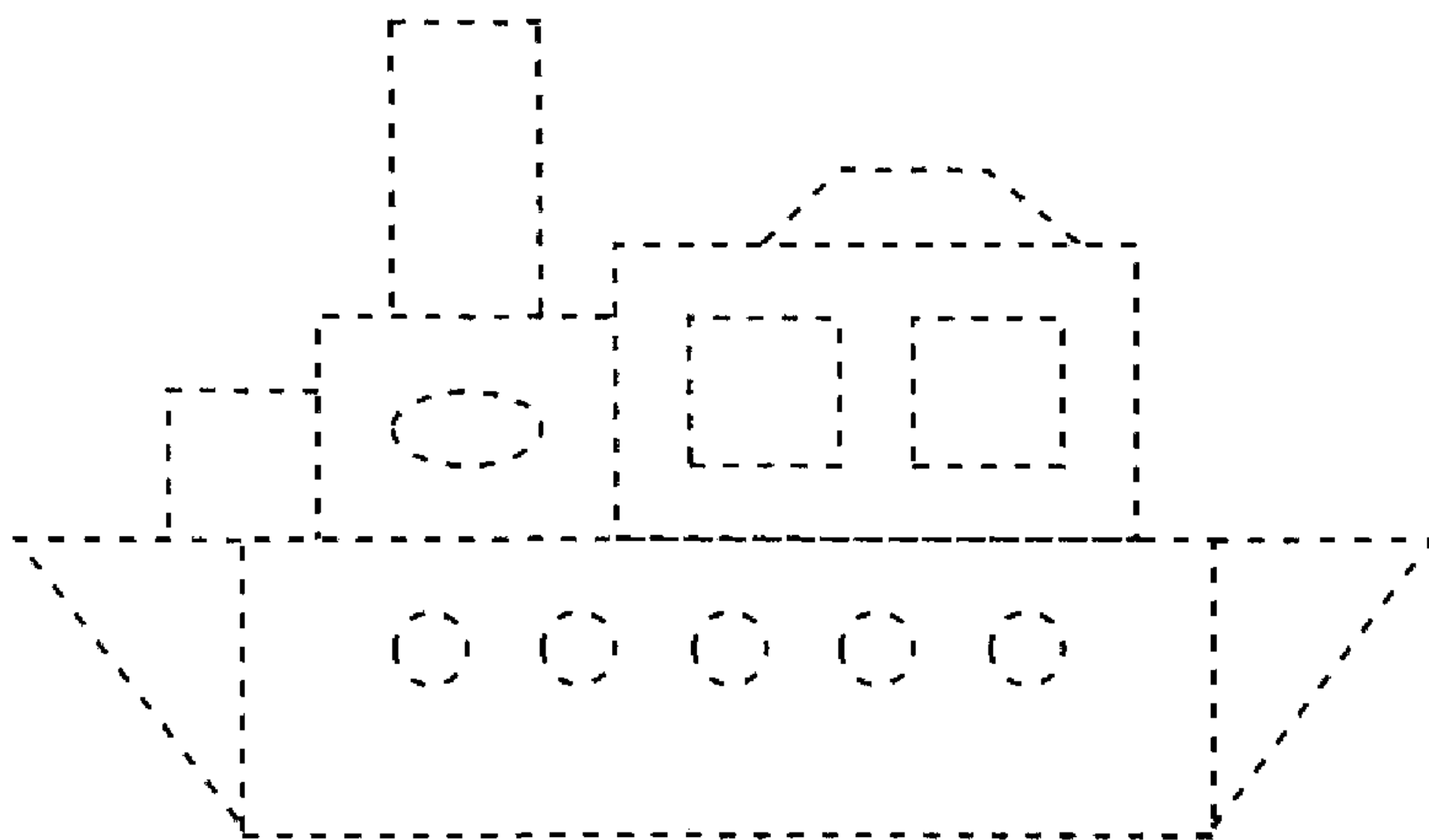
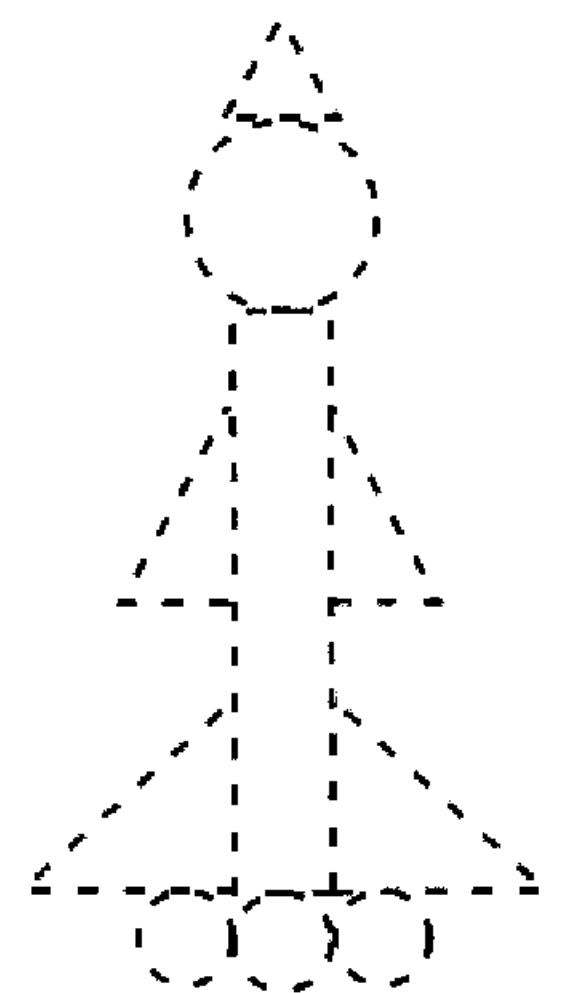
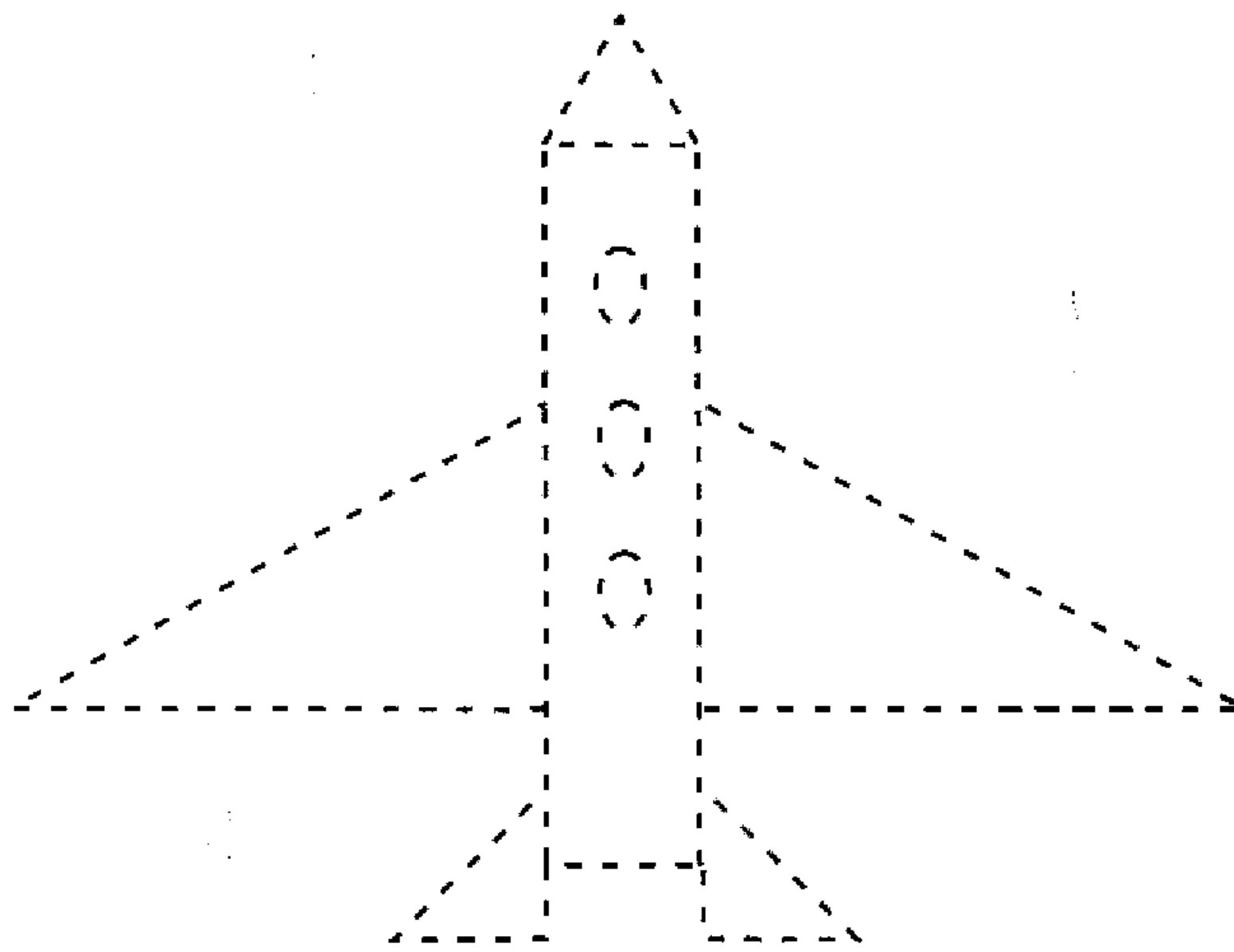
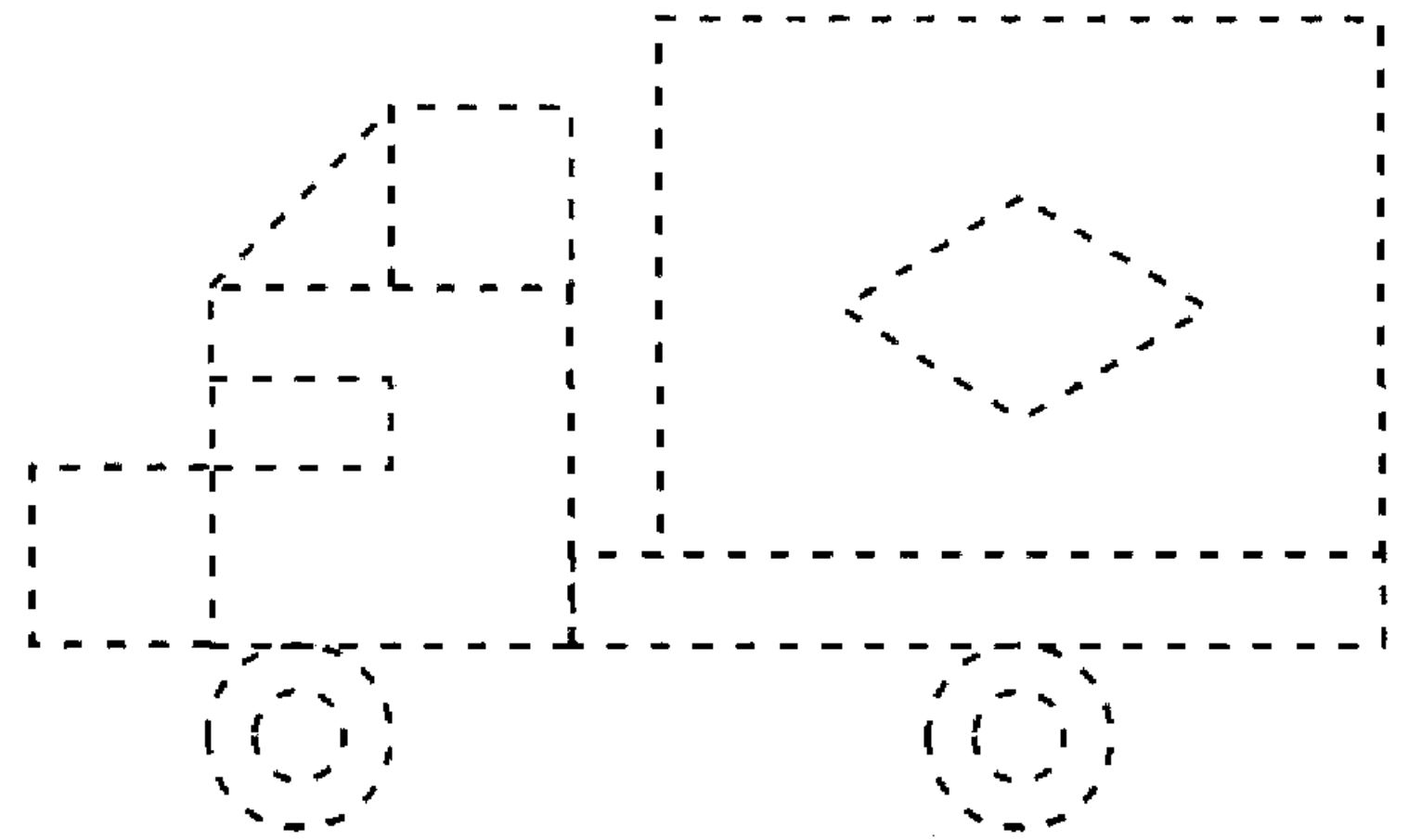
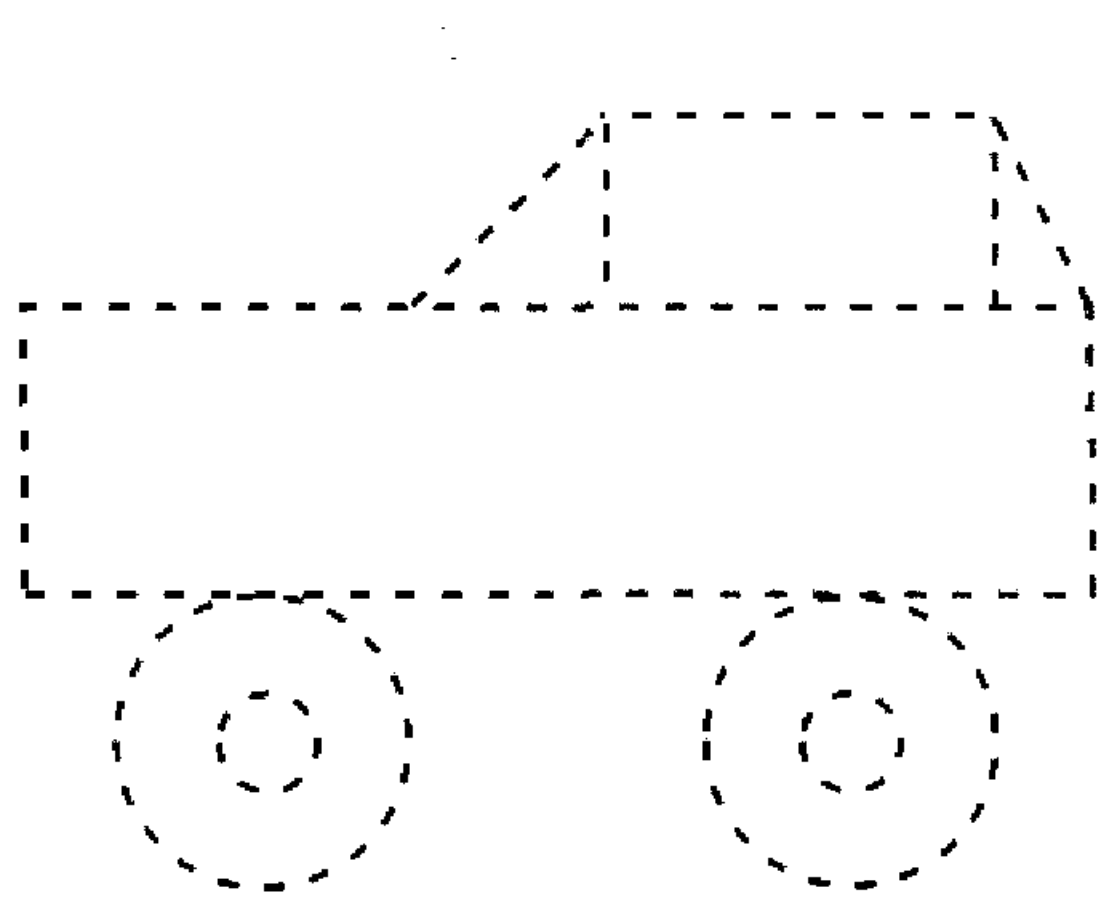



# K

Коала

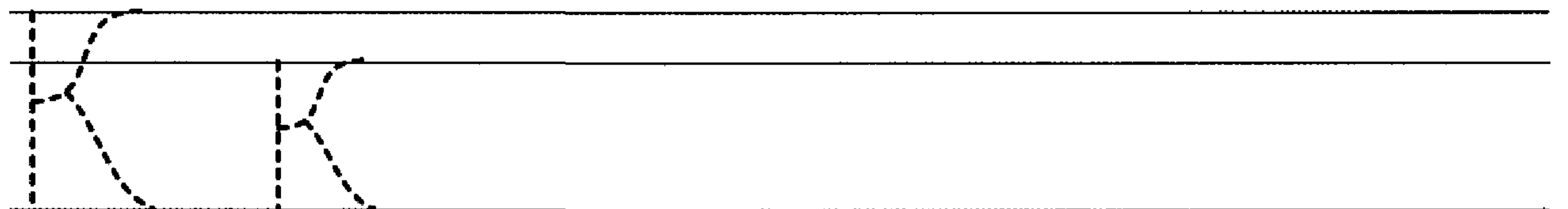
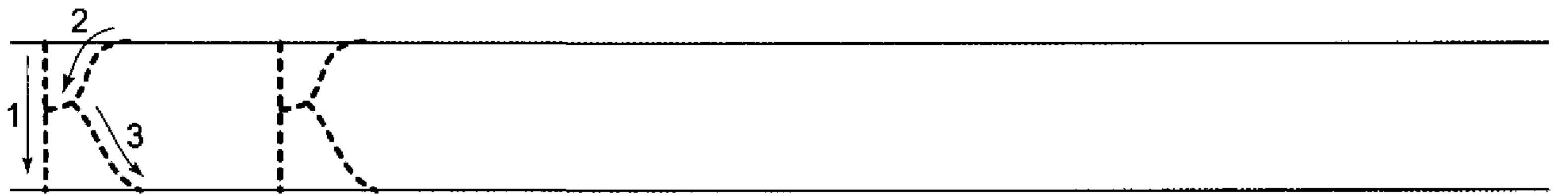
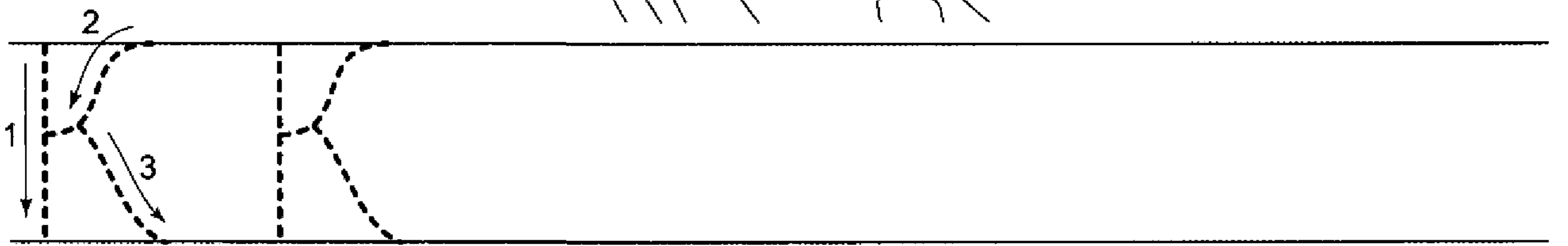

Выполни штриховку прямыми параллельными линиями, не выходя за контур рисунка. Раскрась картинки.

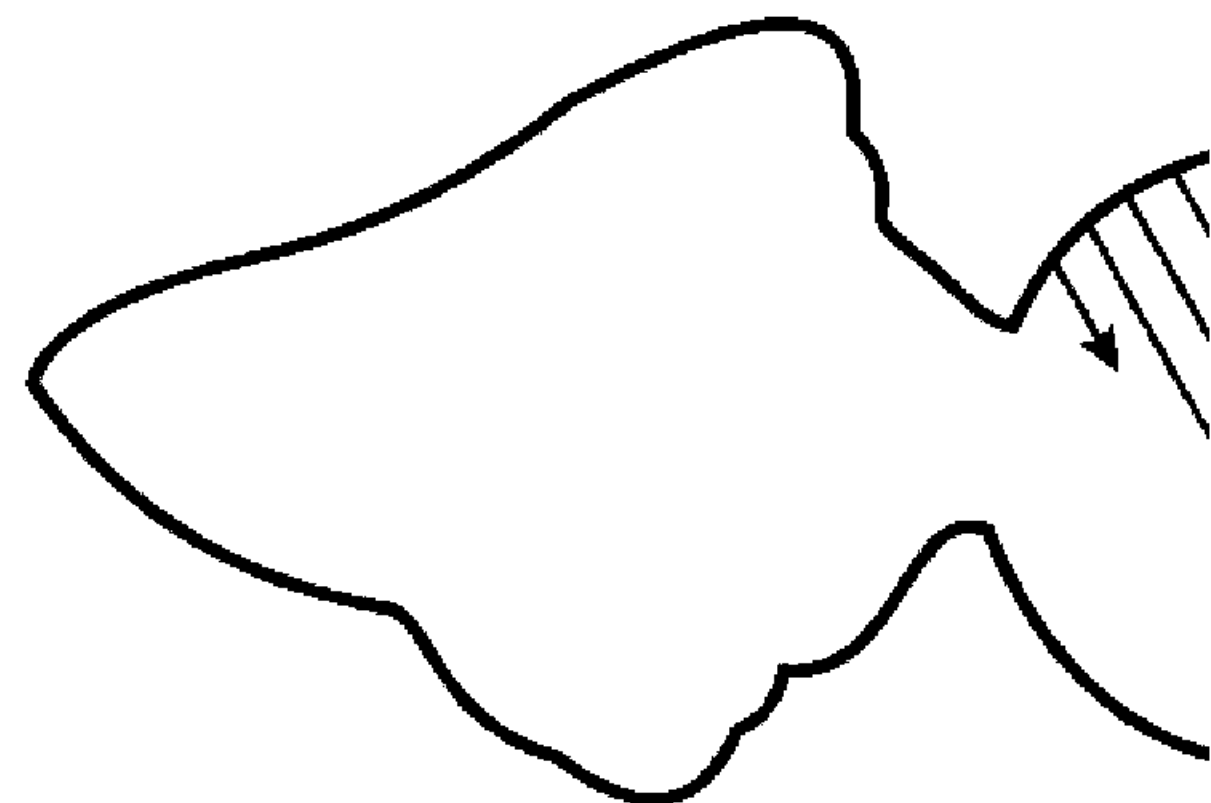
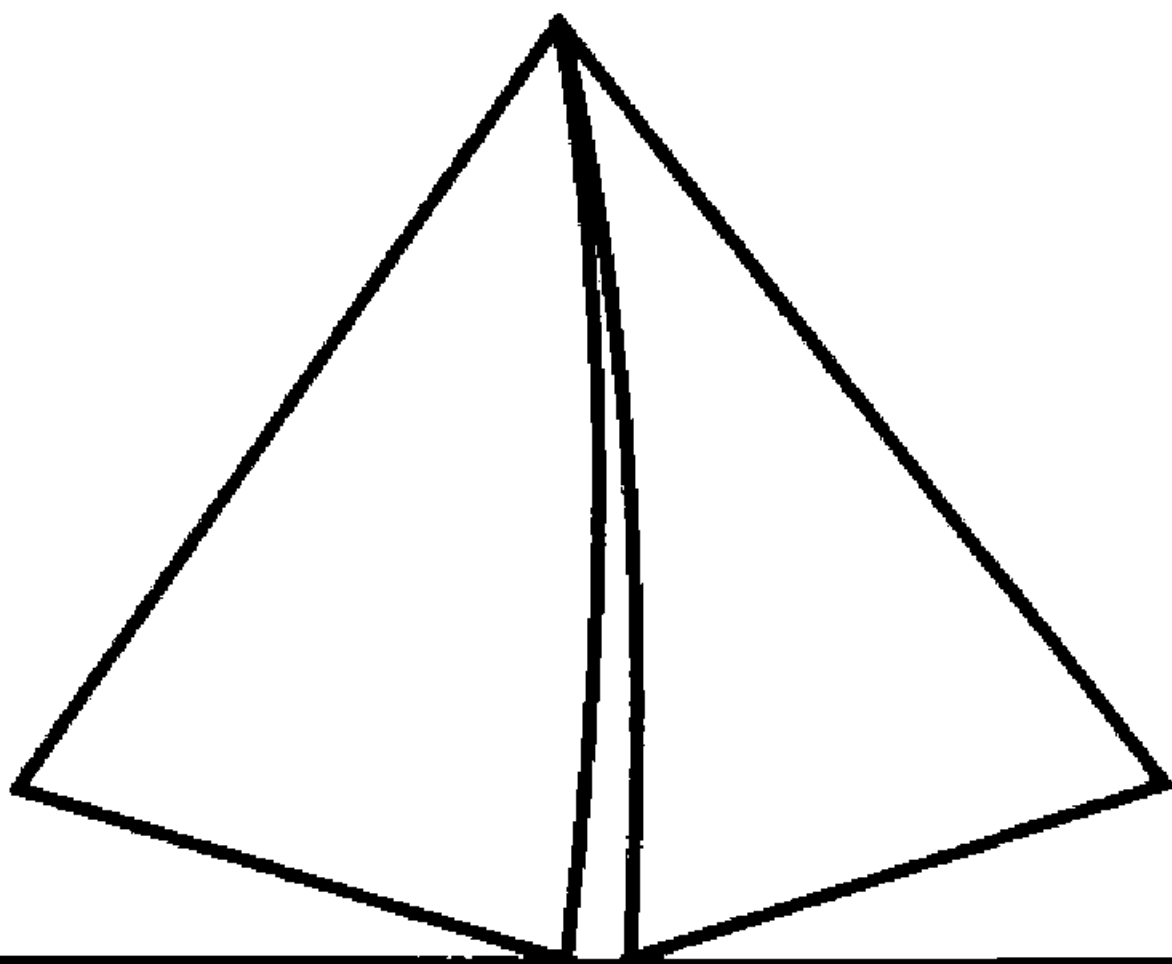
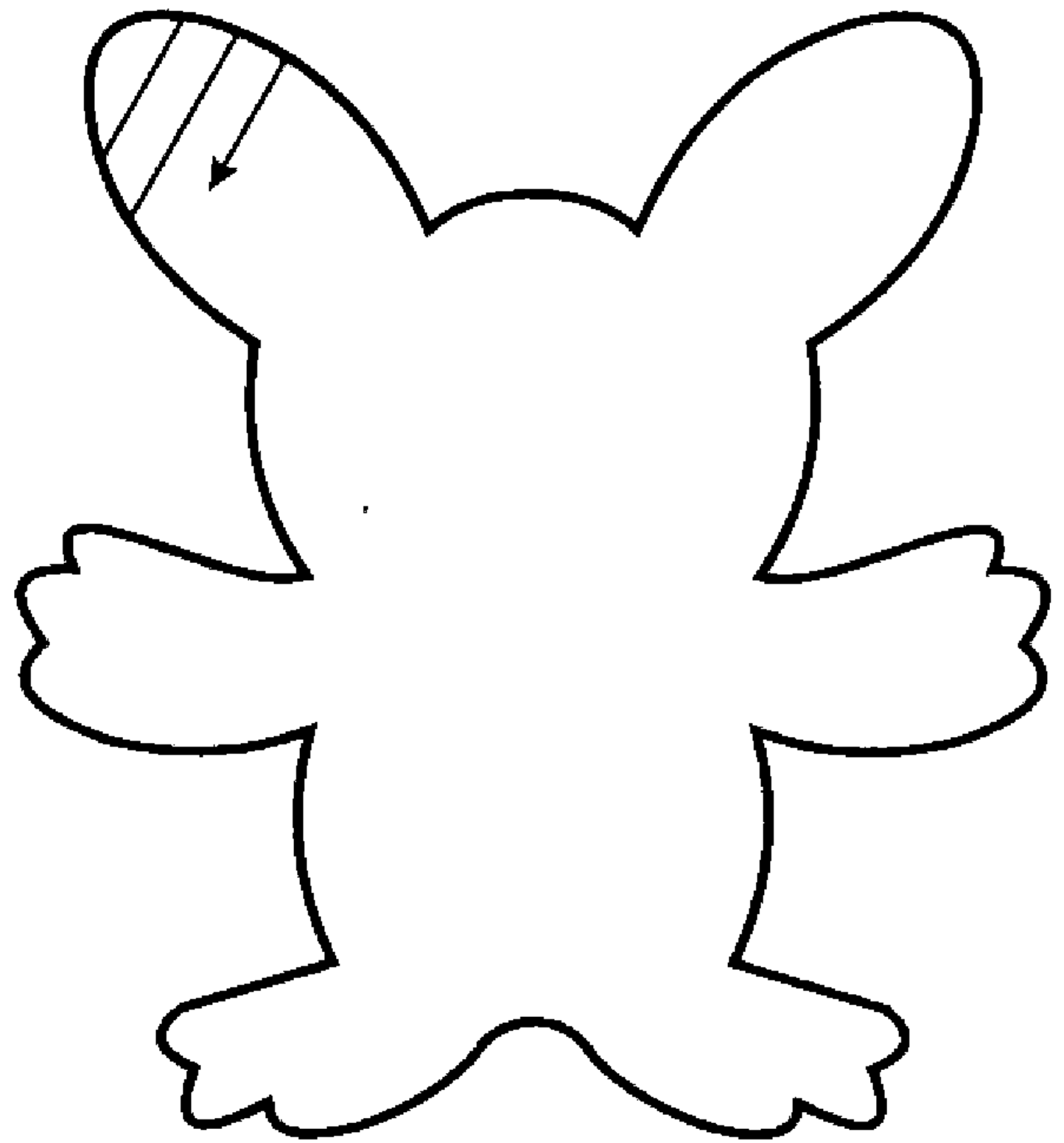
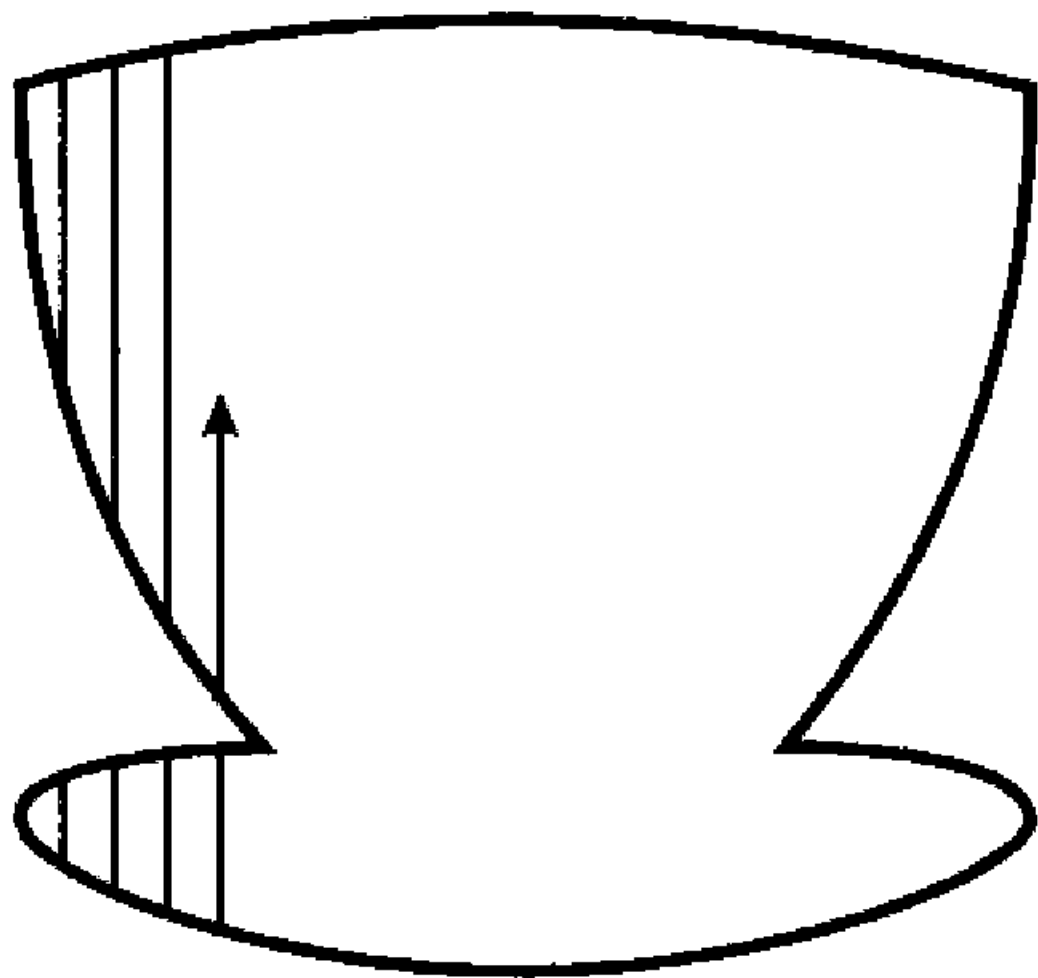
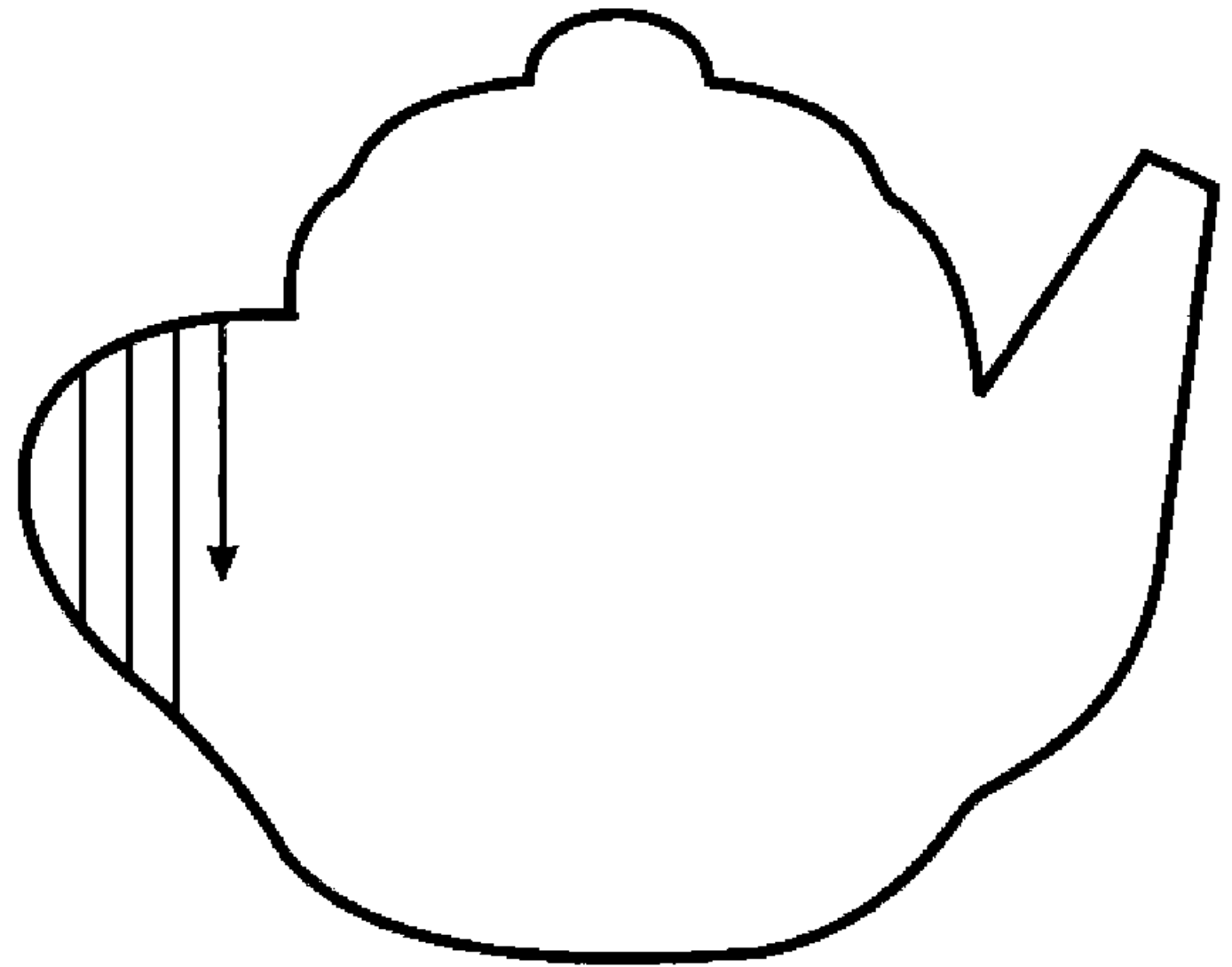
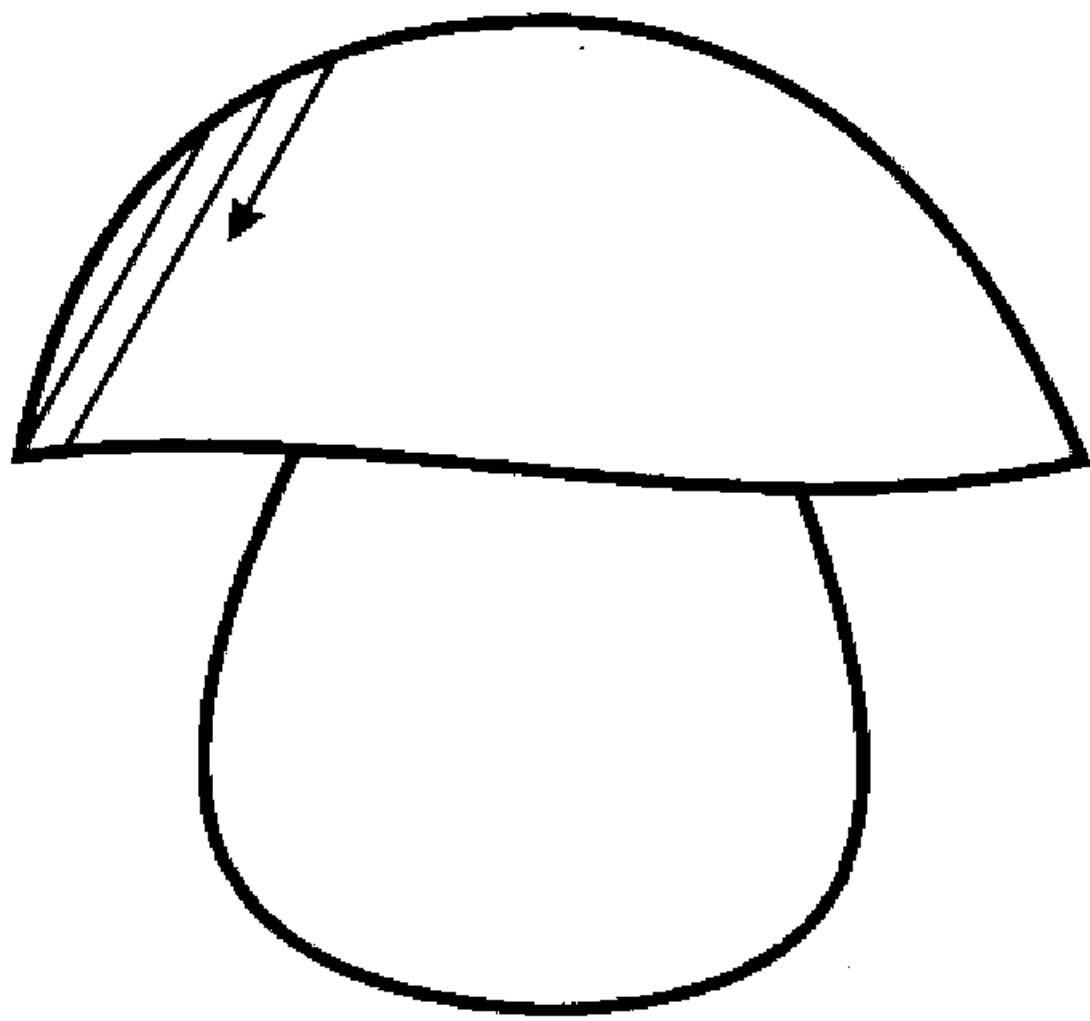

# Л

Лев

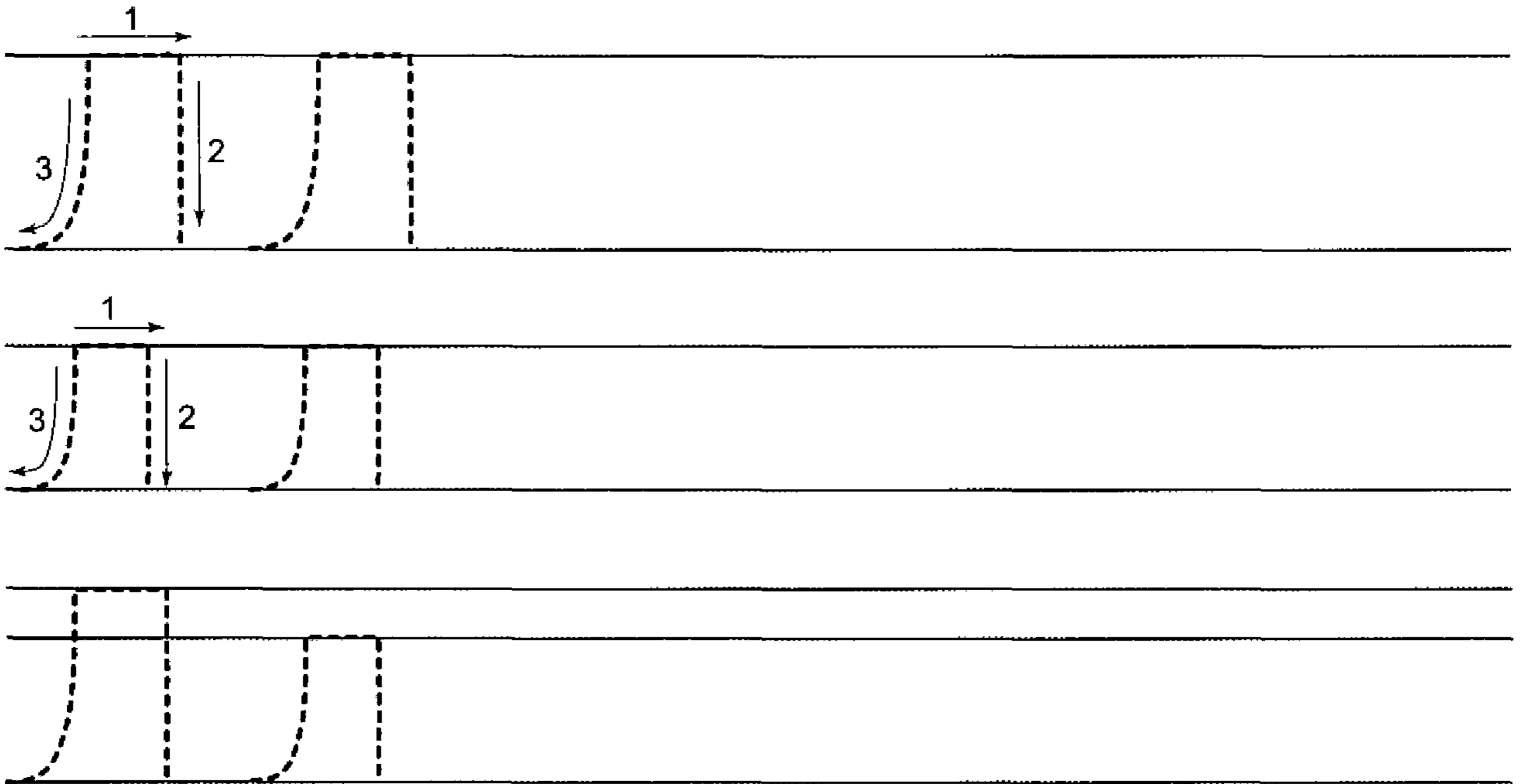
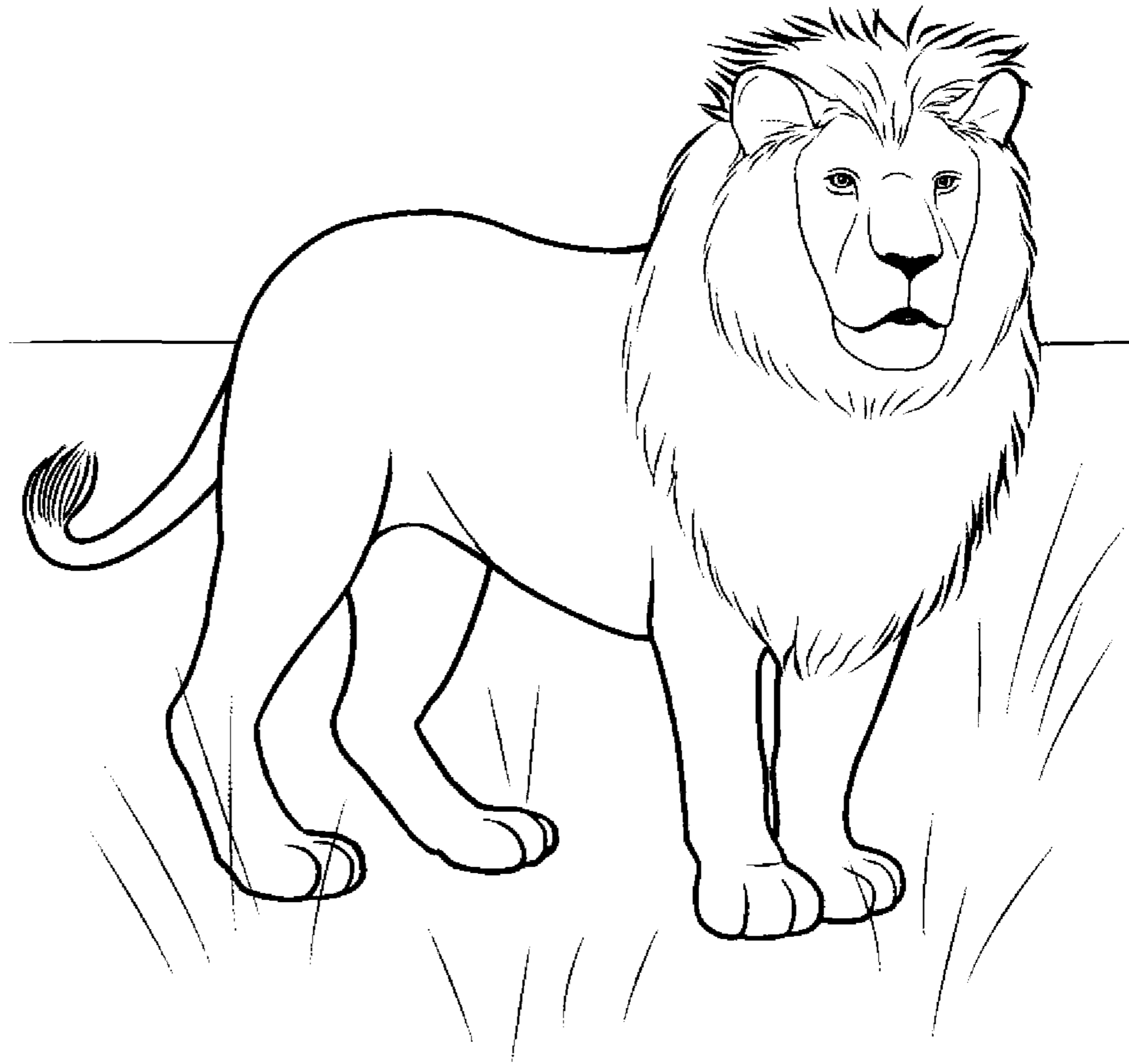

Дорисуй фигуры до конца строки и раскрась их.

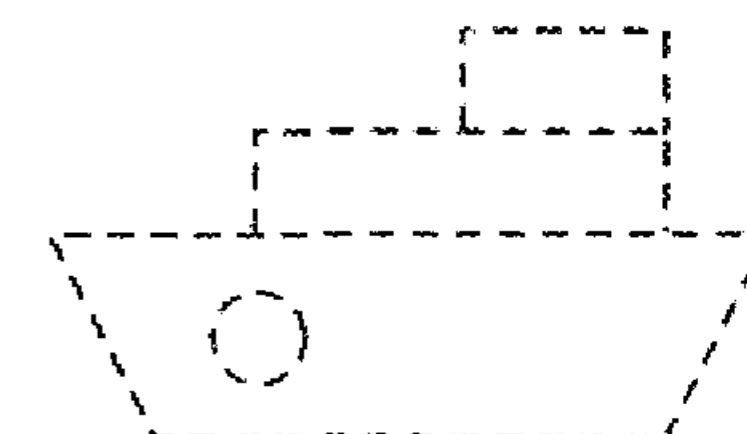
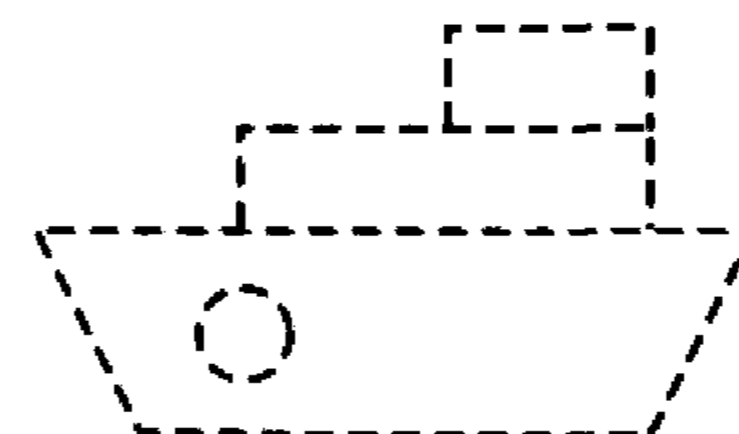
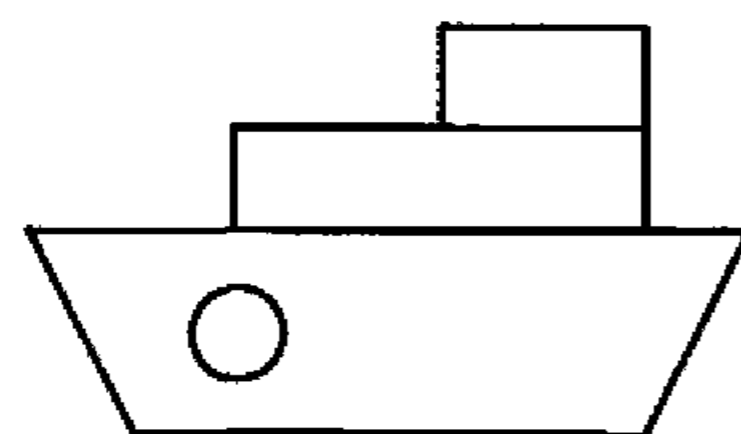
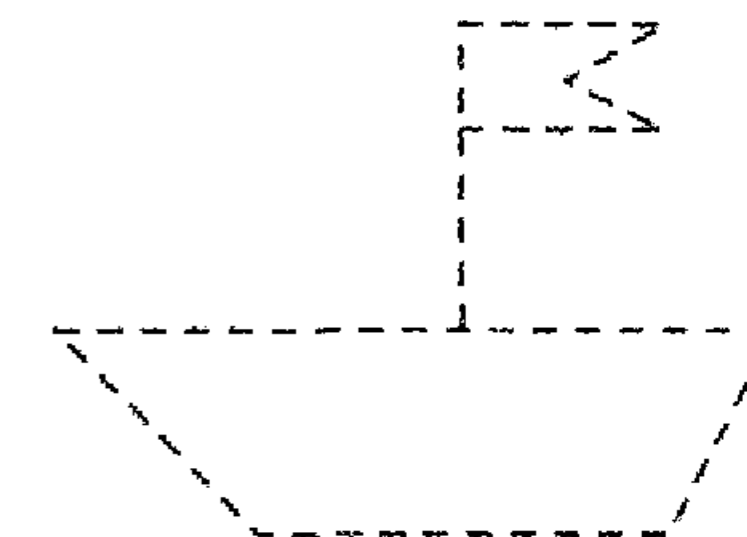
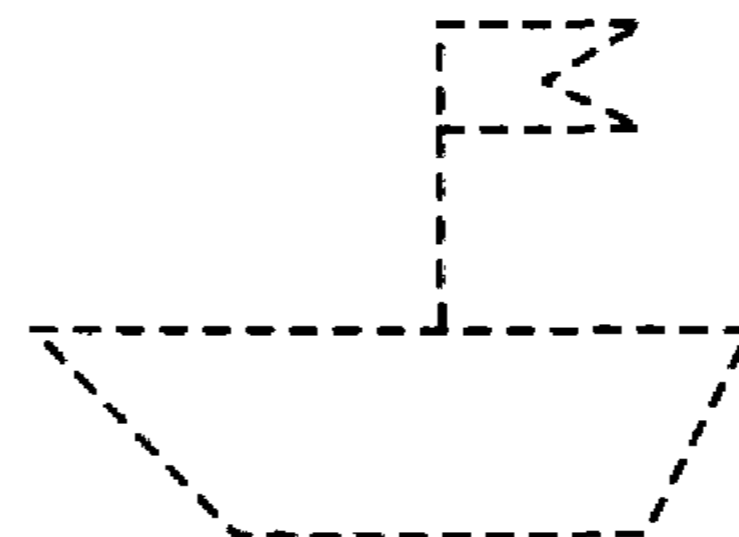
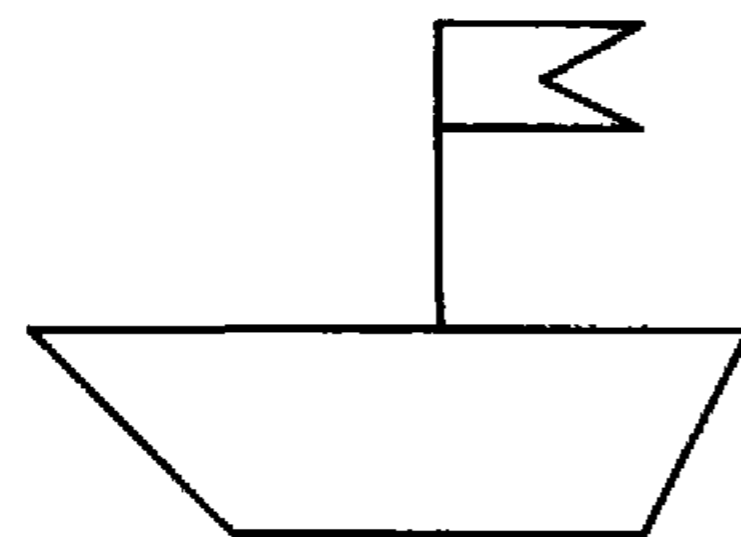
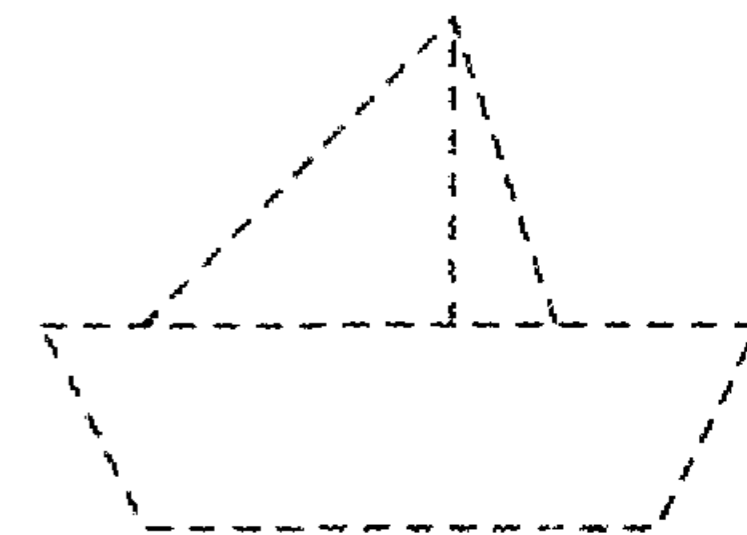
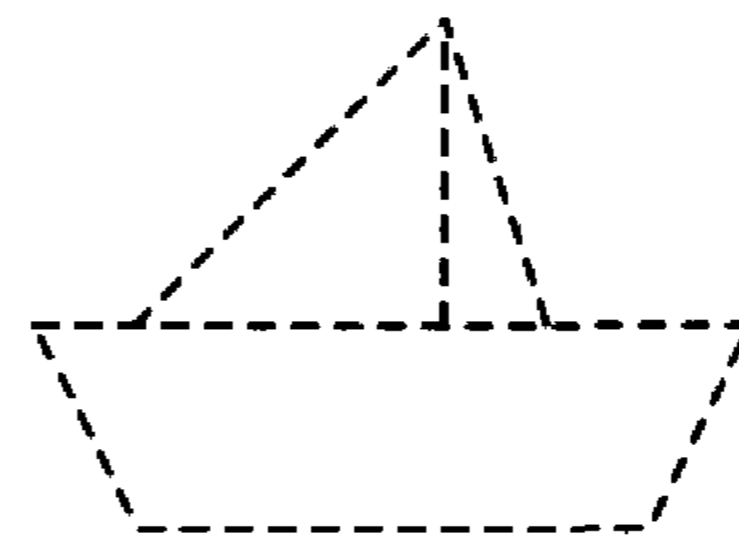
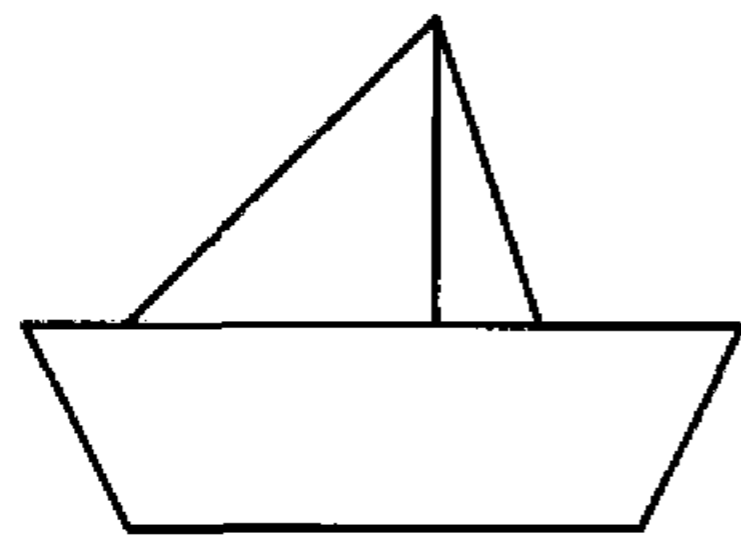
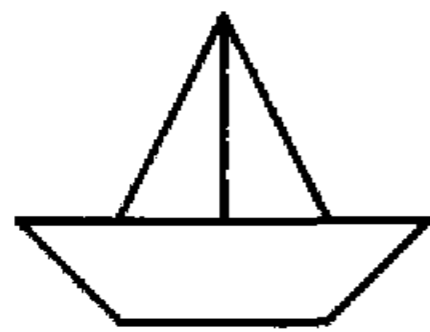
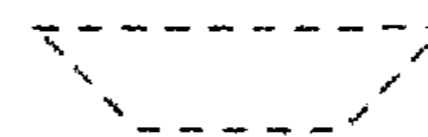
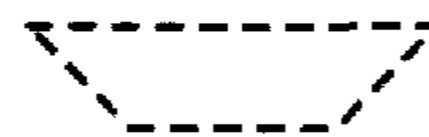
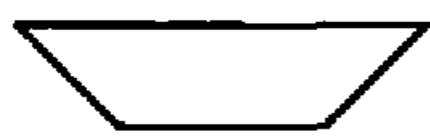
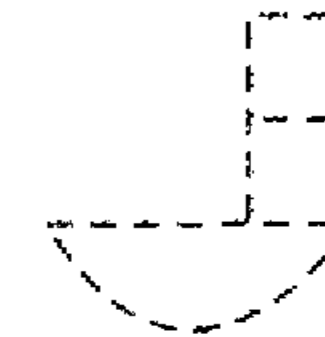
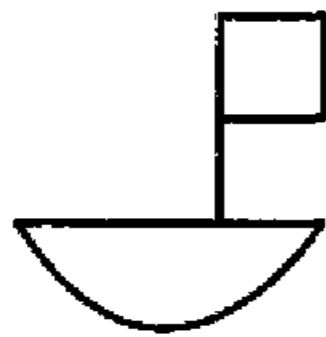

# M

Медведь

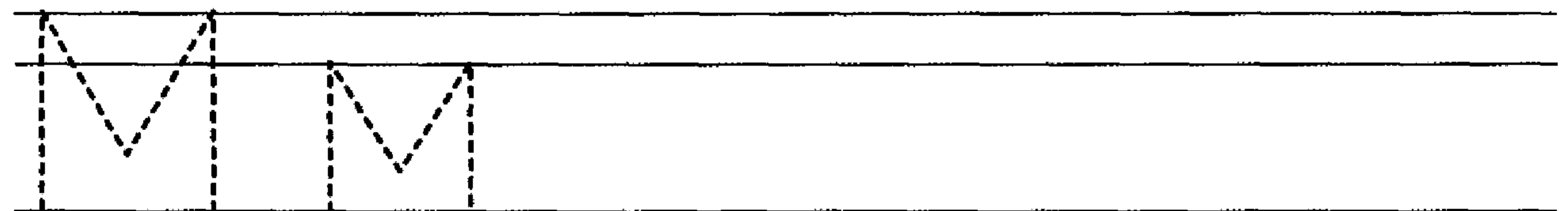
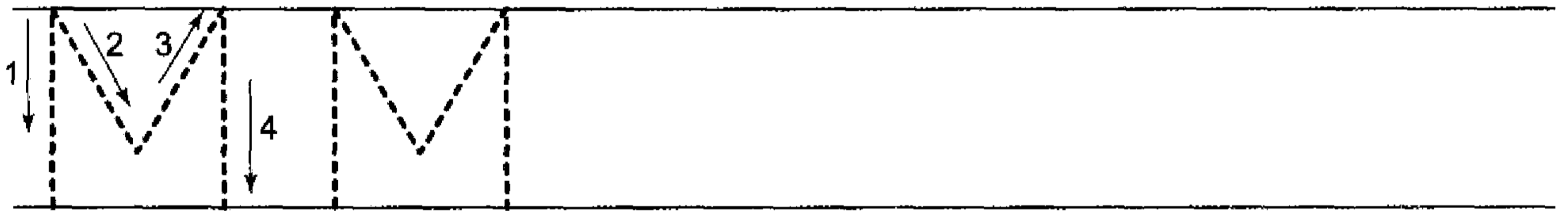
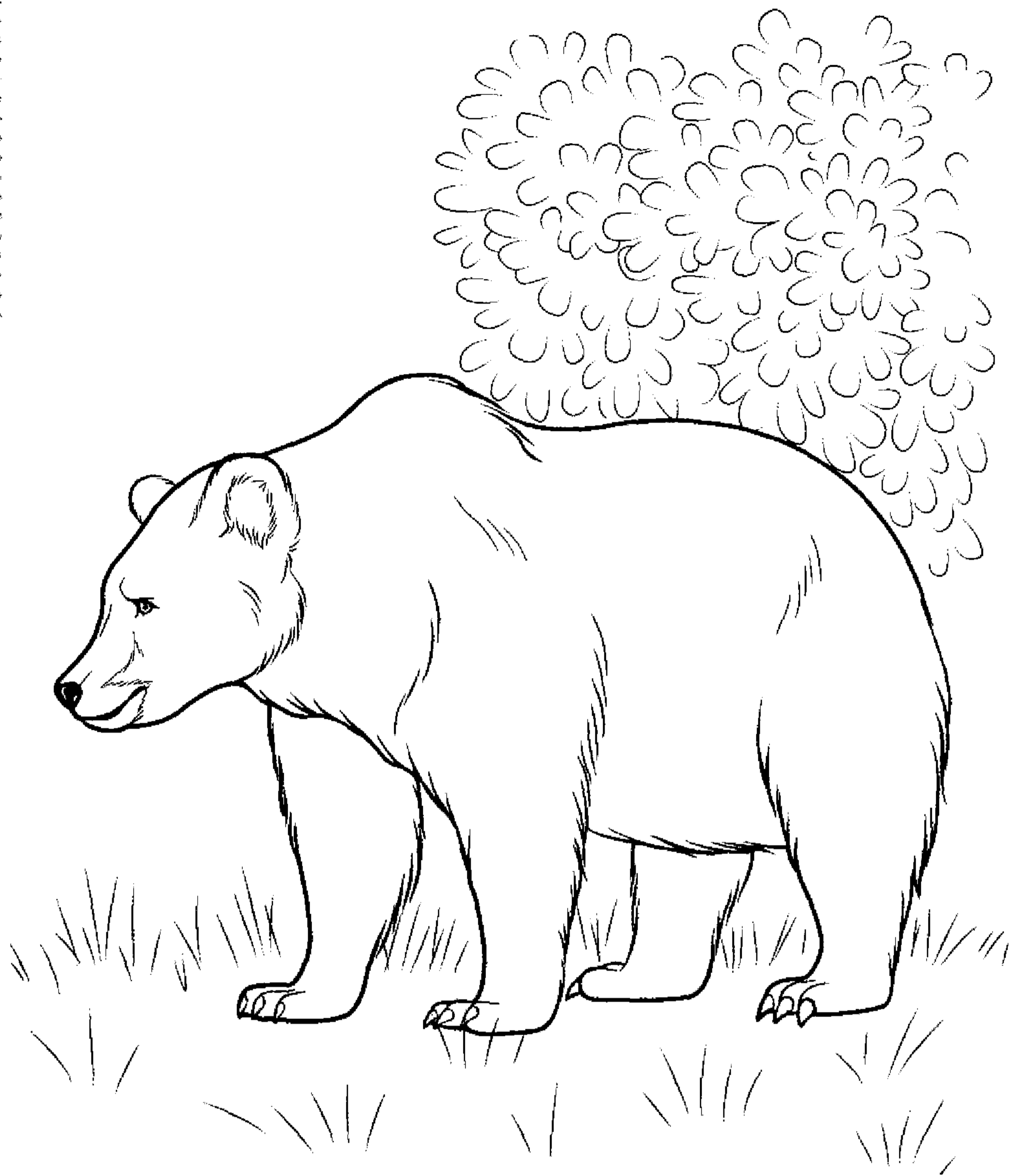

Проведи линии по дорожкам, не отрывая карандаш от бумаги и не выходя за края дорожек. Раскрась дорожки.

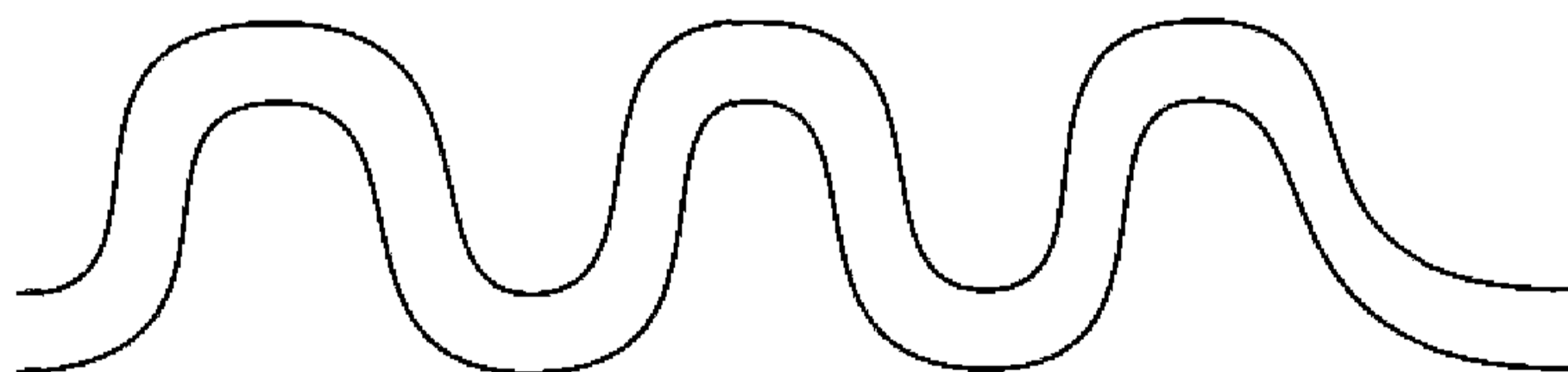
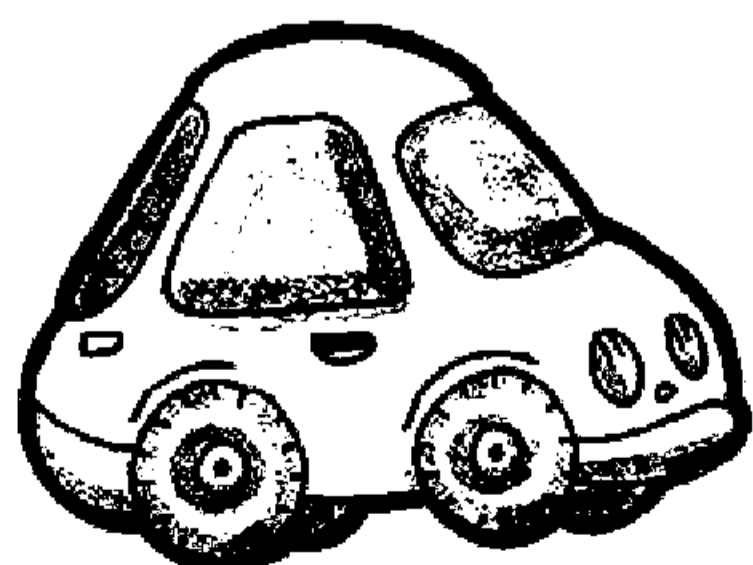
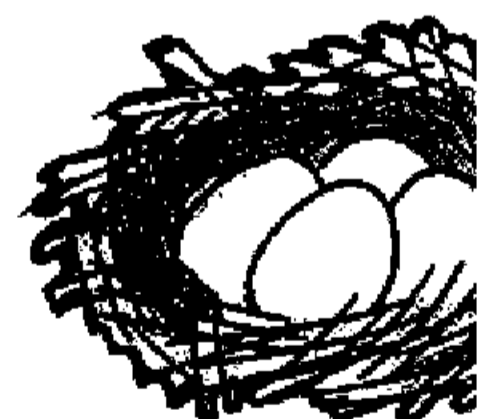
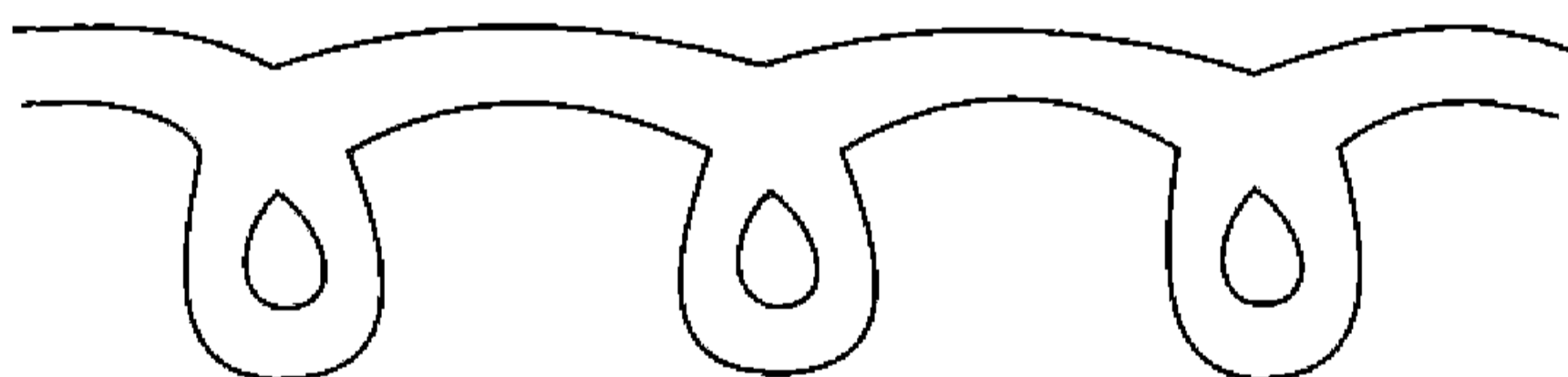
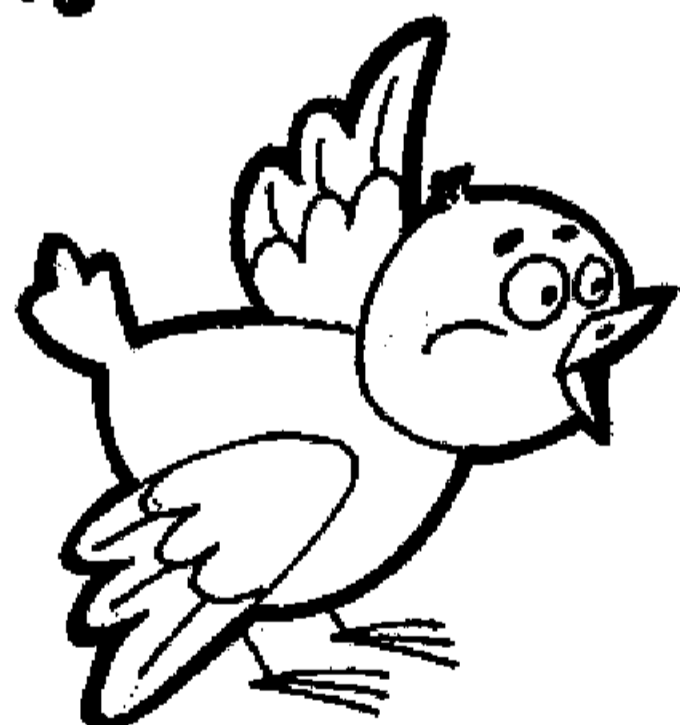
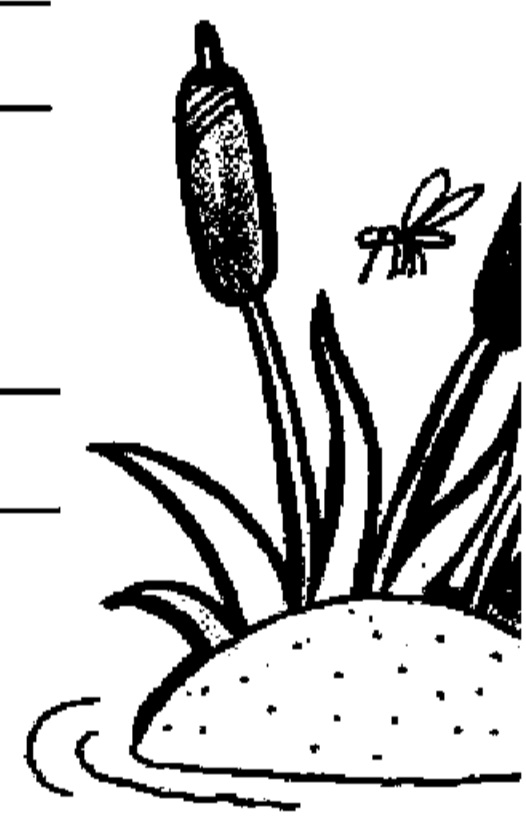
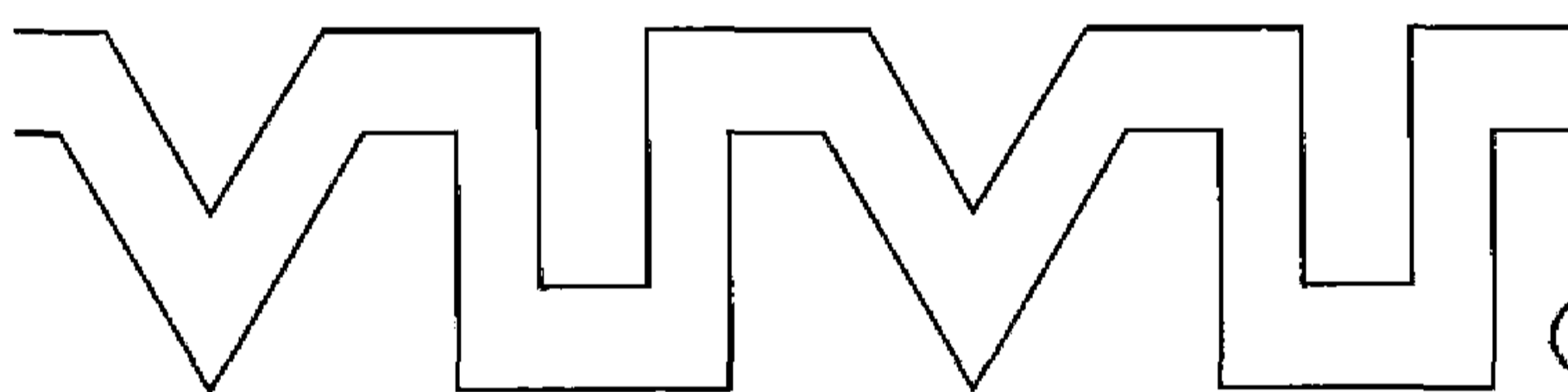
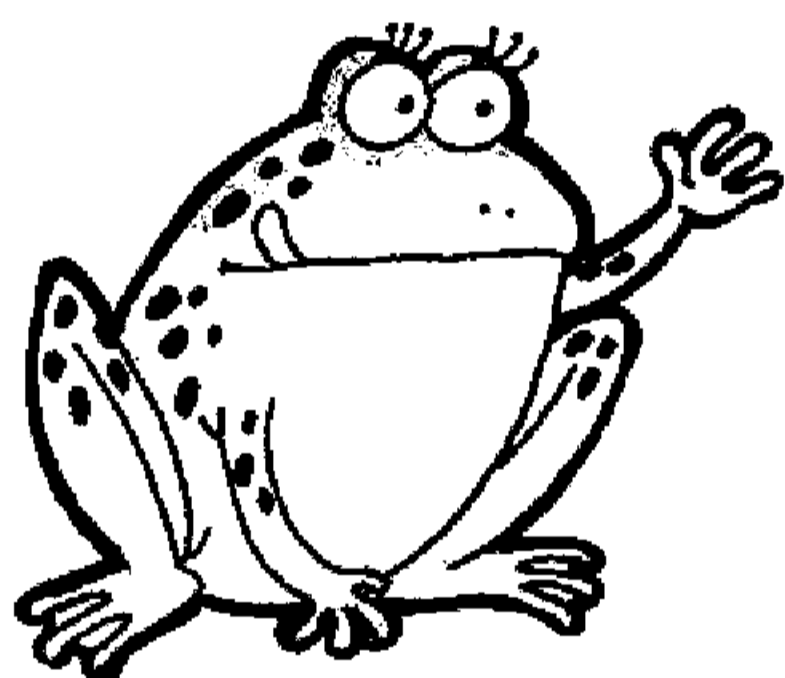
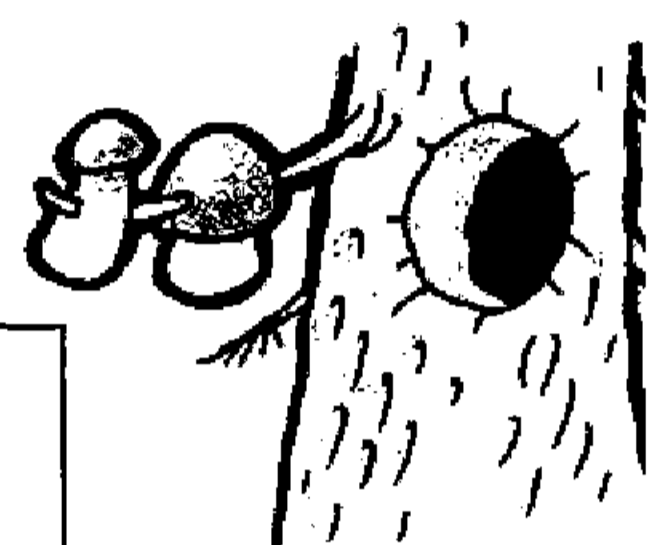
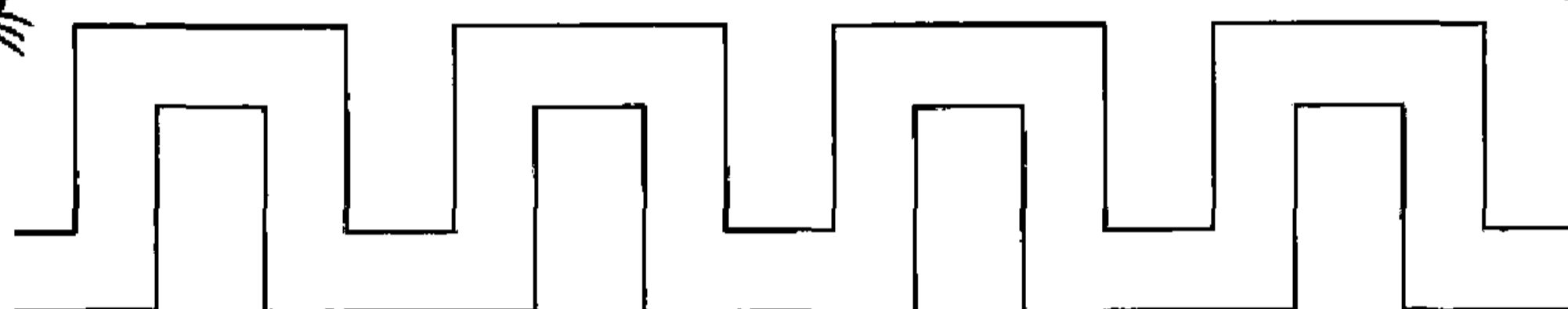
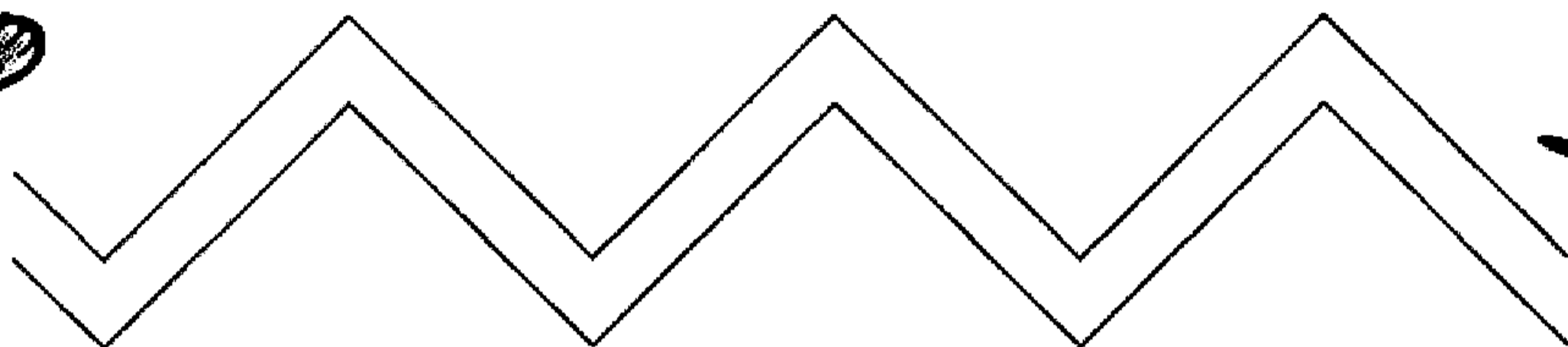

# Н

Носорог

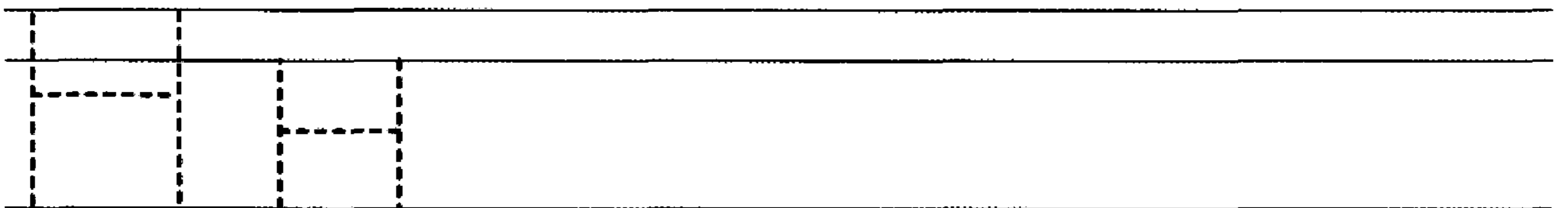
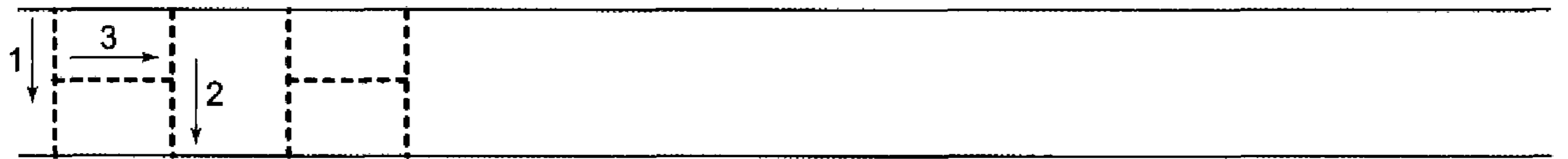
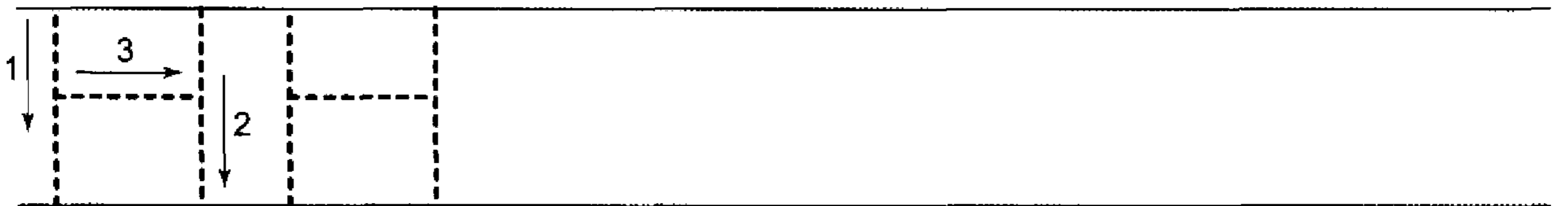
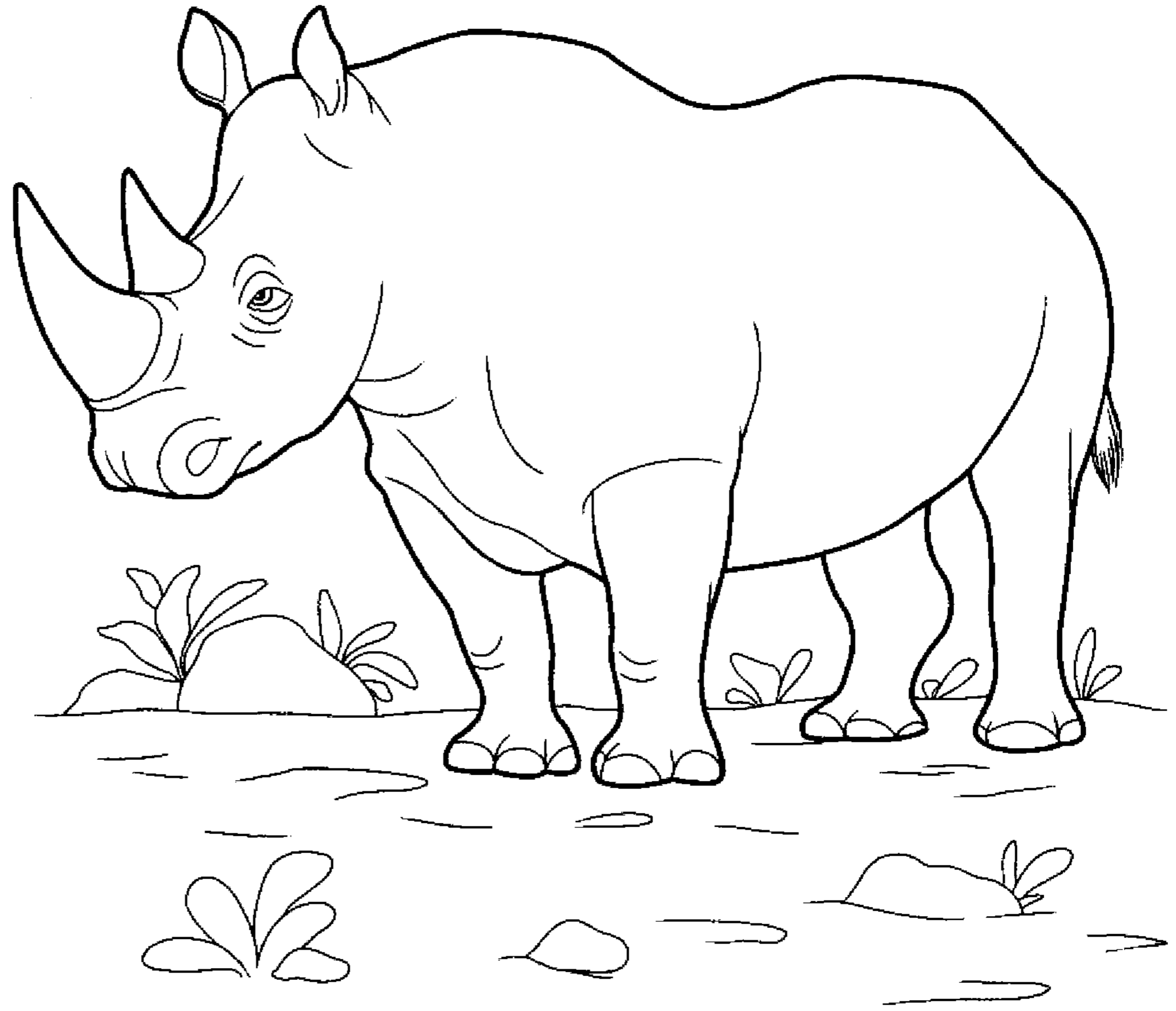

Выполни штриховку параллельными линиями, не выходя за контур рисунка. Раскрась картинки.

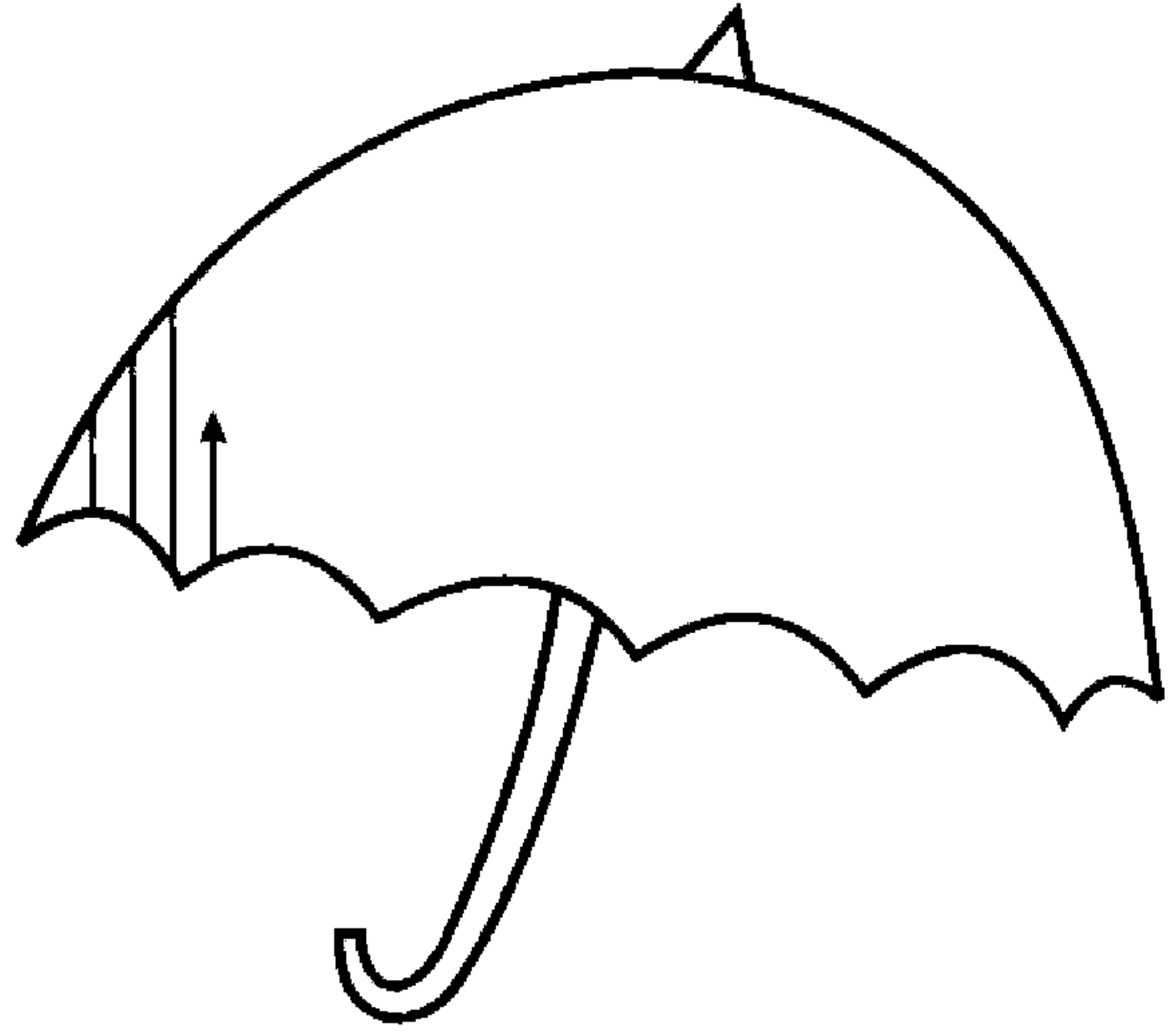
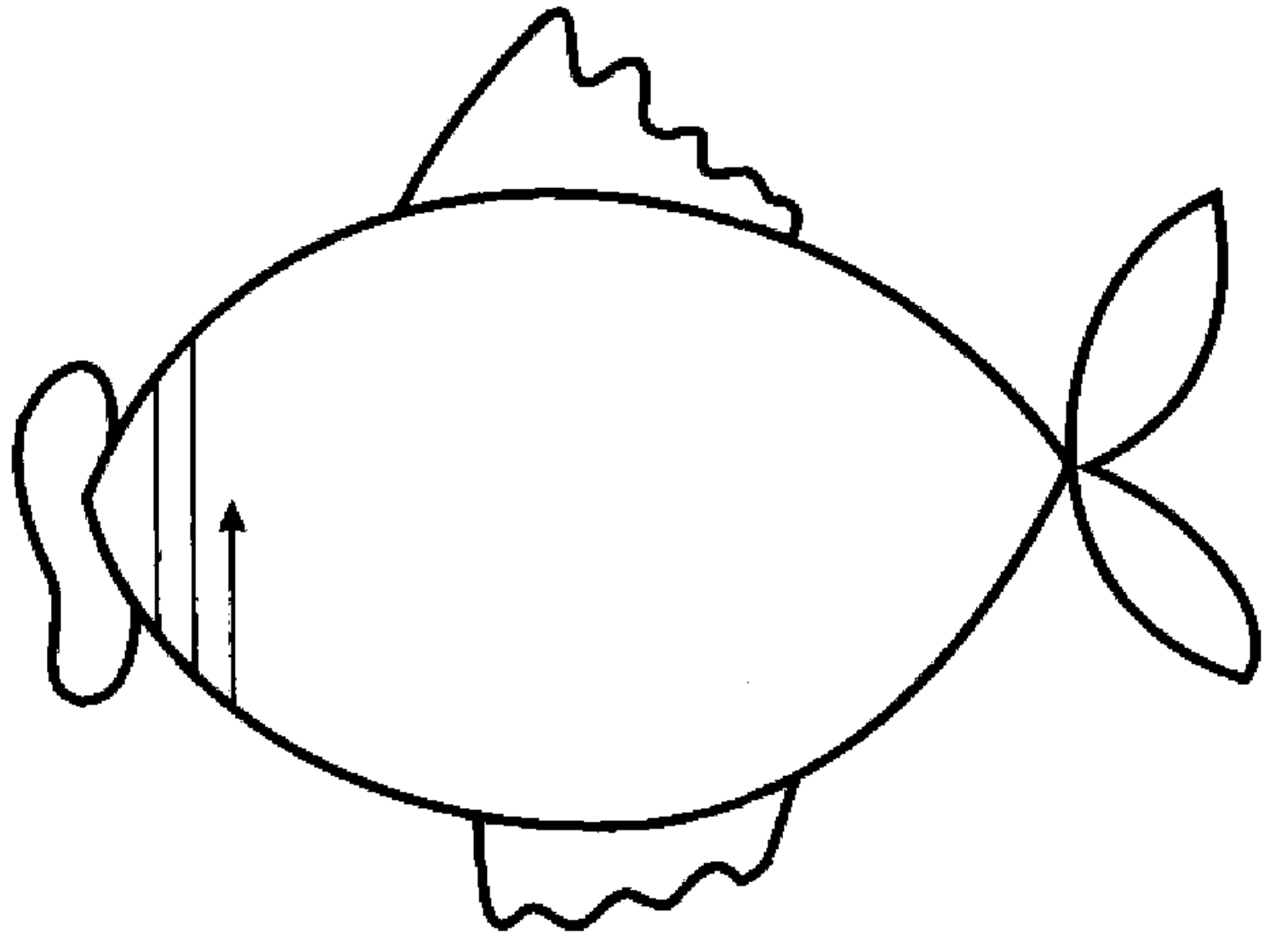
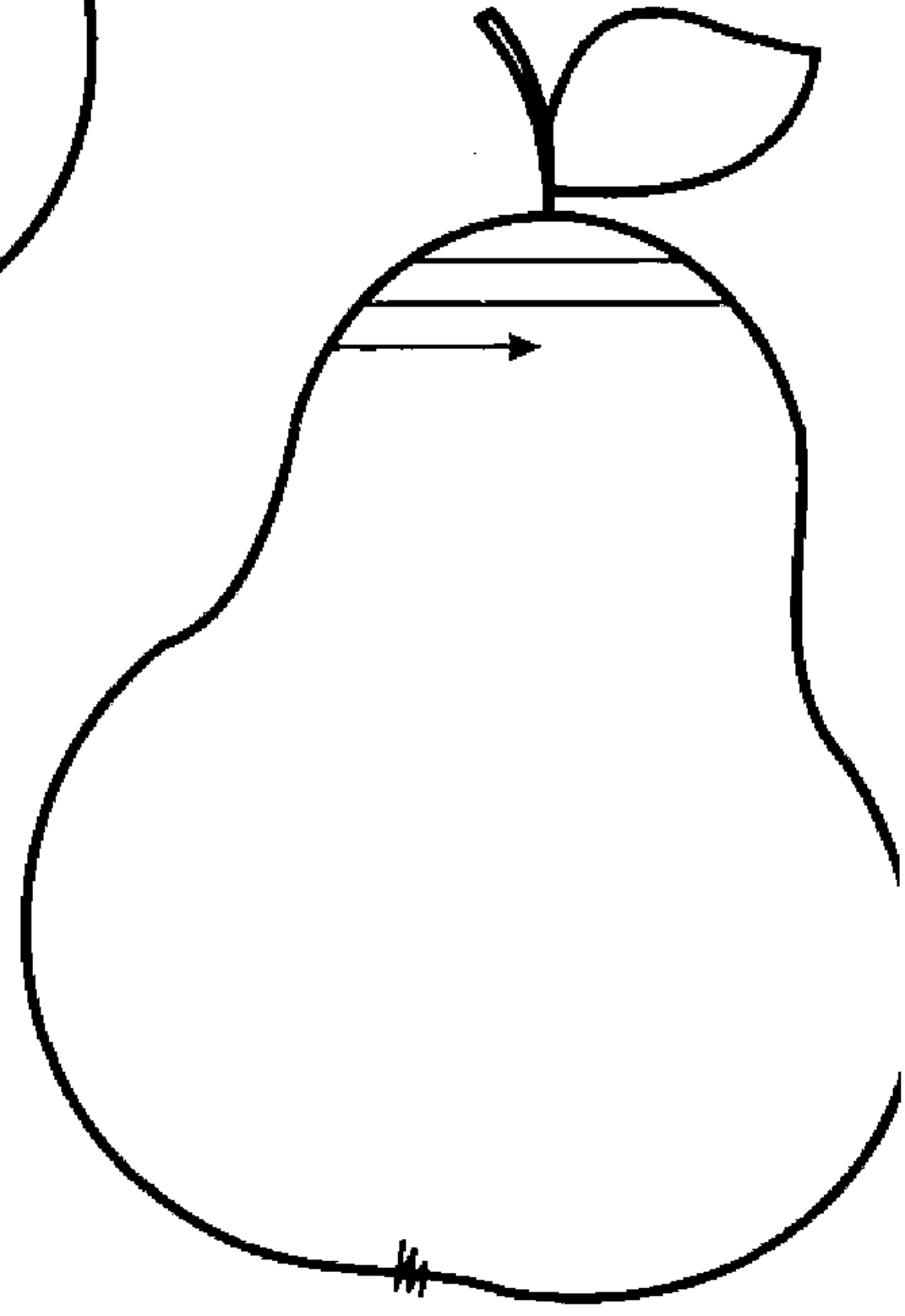
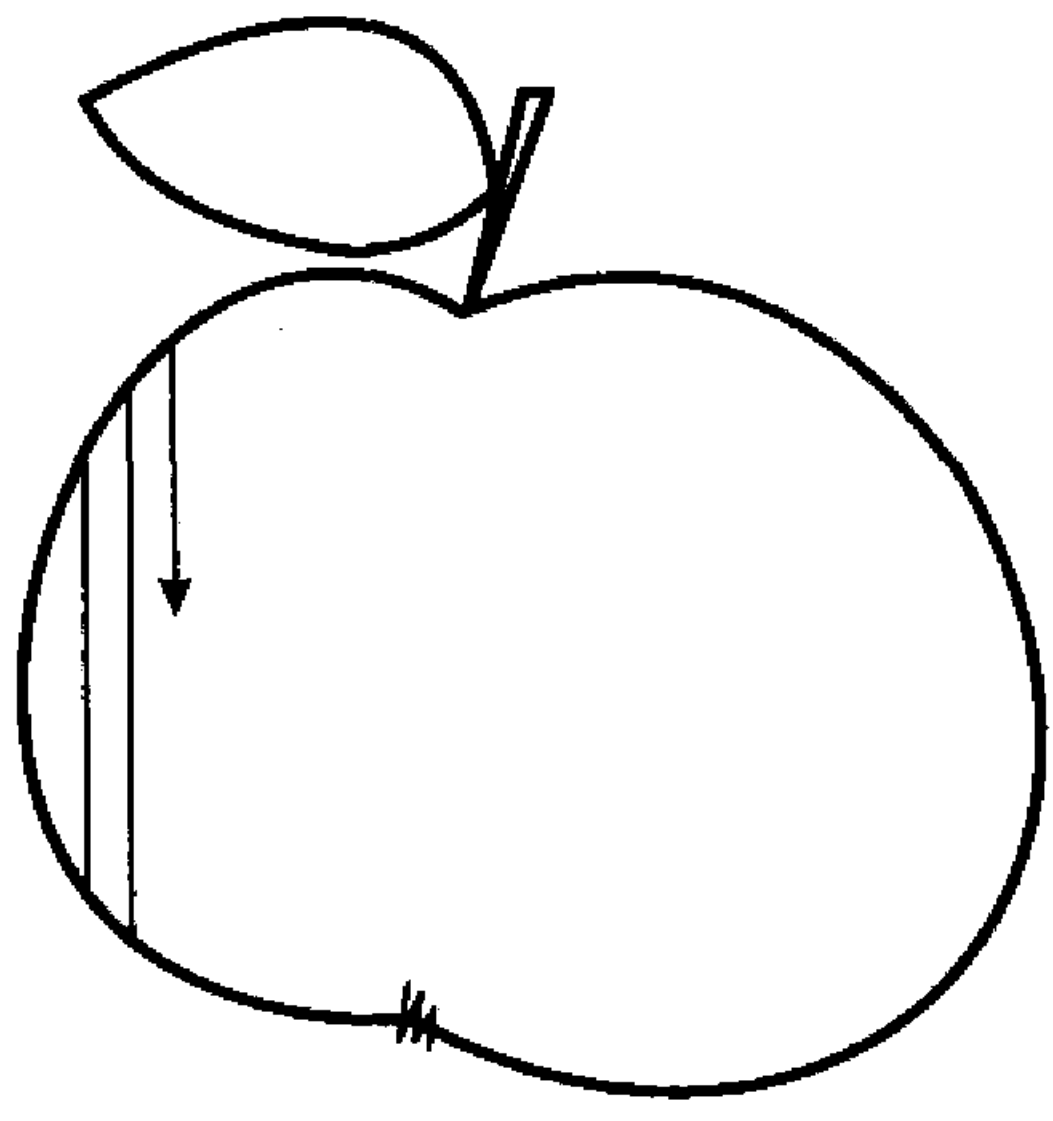
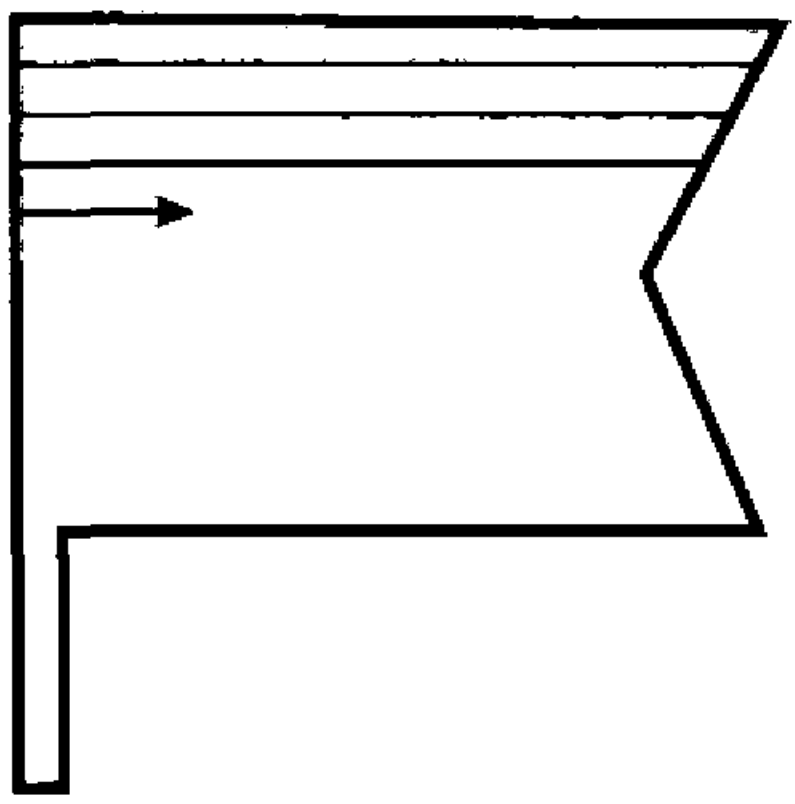



O

Орёл



Handwriting practice section consisting of three rows of horizontal lines. Each row contains a dashed outline of the letter 'O' with numbered arrows indicating the stroke order, followed by a plain dashed outline of the letter 'O' for tracing.

- Row 1: Shows the stroke order for a lowercase 'o'. Stroke 1 is a counter-clockwise circle starting from the top. Stroke 2 is a horizontal line across the middle from left to right.
- Row 2: Shows the stroke order for an uppercase 'O'. Stroke 1 is a counter-clockwise circle starting from the top. Stroke 2 is a horizontal line across the middle from left to right. Stroke 3 is a horizontal line across the bottom from left to right.
- Row 3: Shows a dashed outline of a lowercase 'o' followed by a dashed outline of an uppercase 'O' for tracing practice.

Обведи картинки точно по линиям, не отрывая карандаш от бумаги. Раскрась картинки.

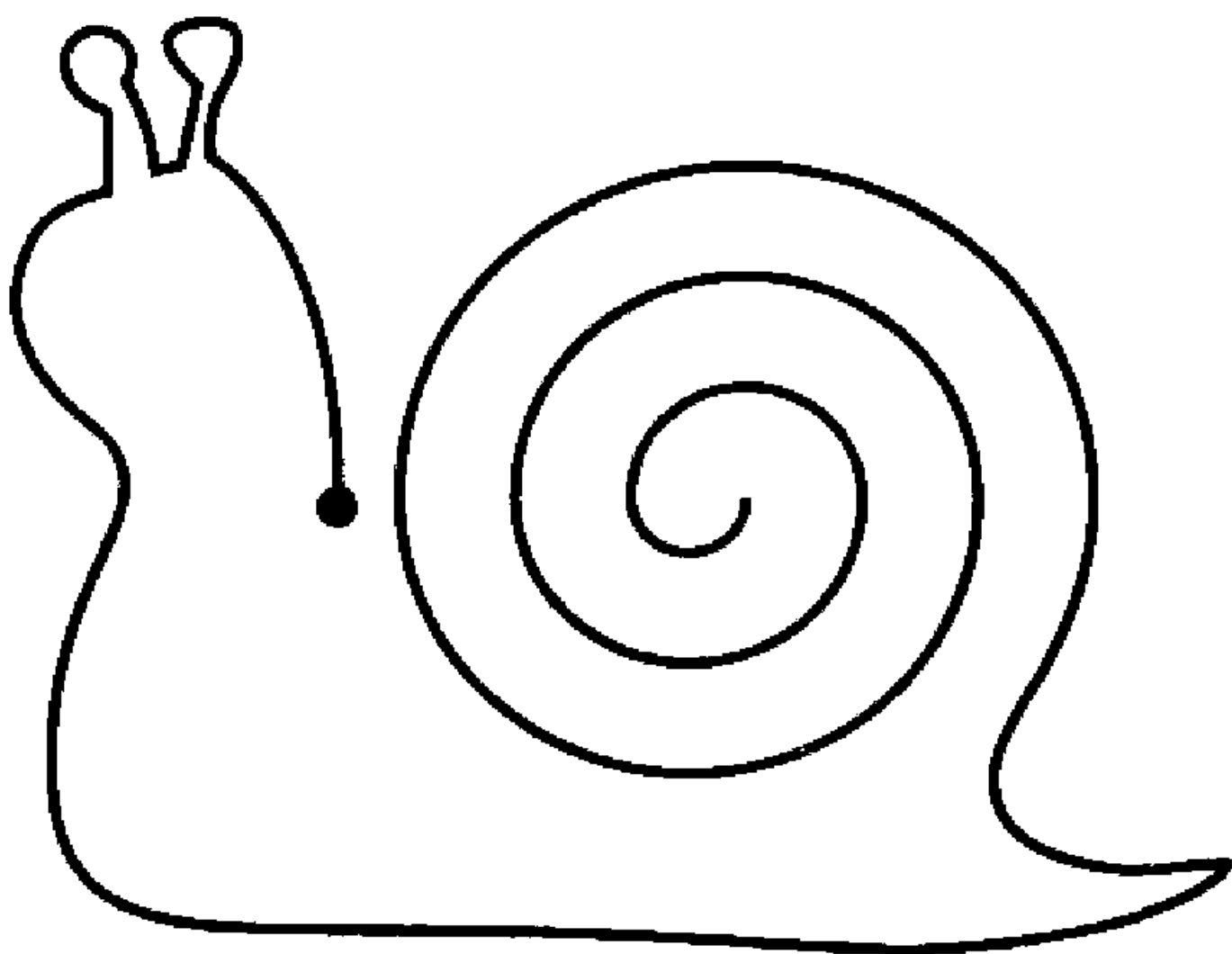
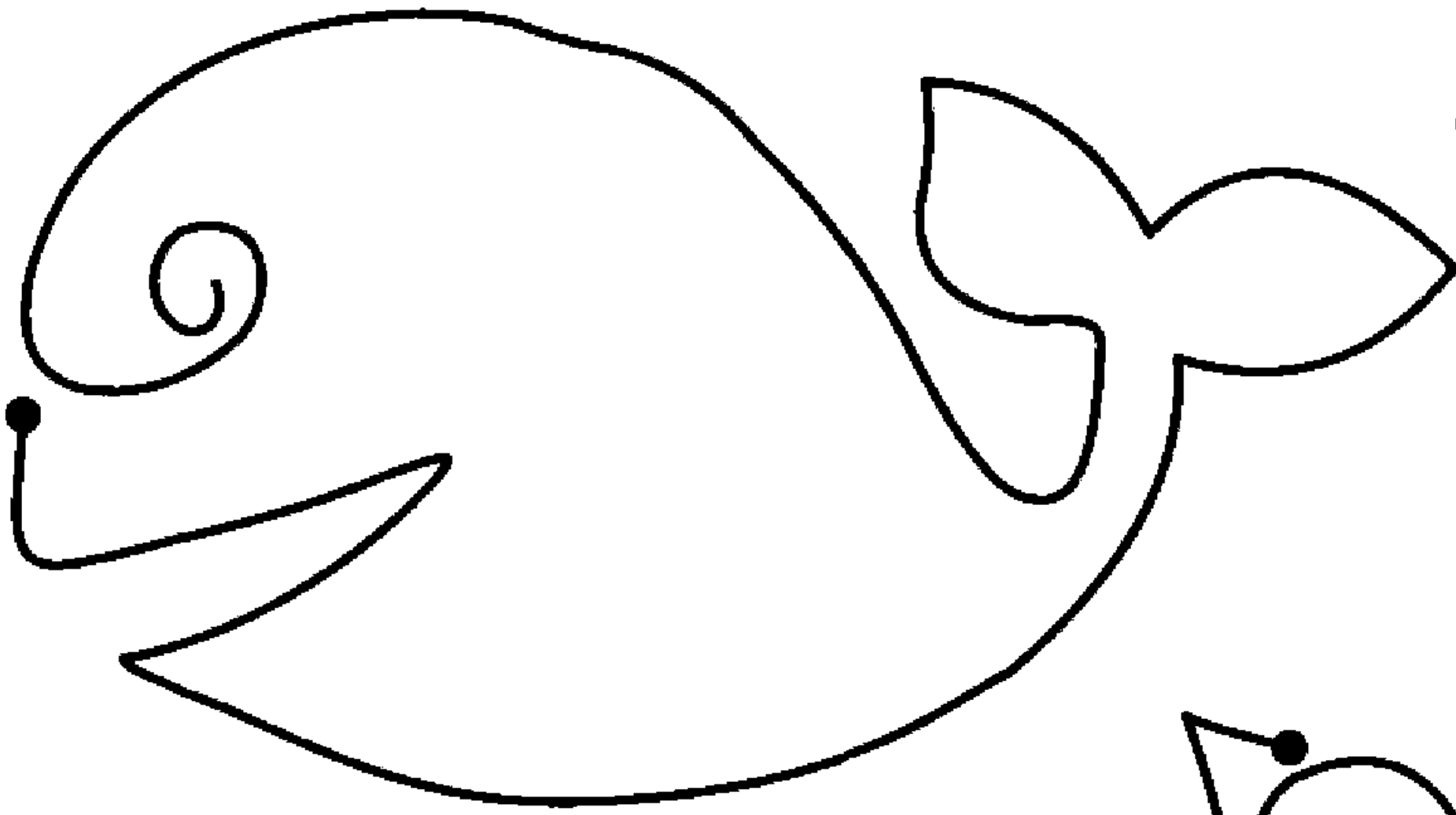
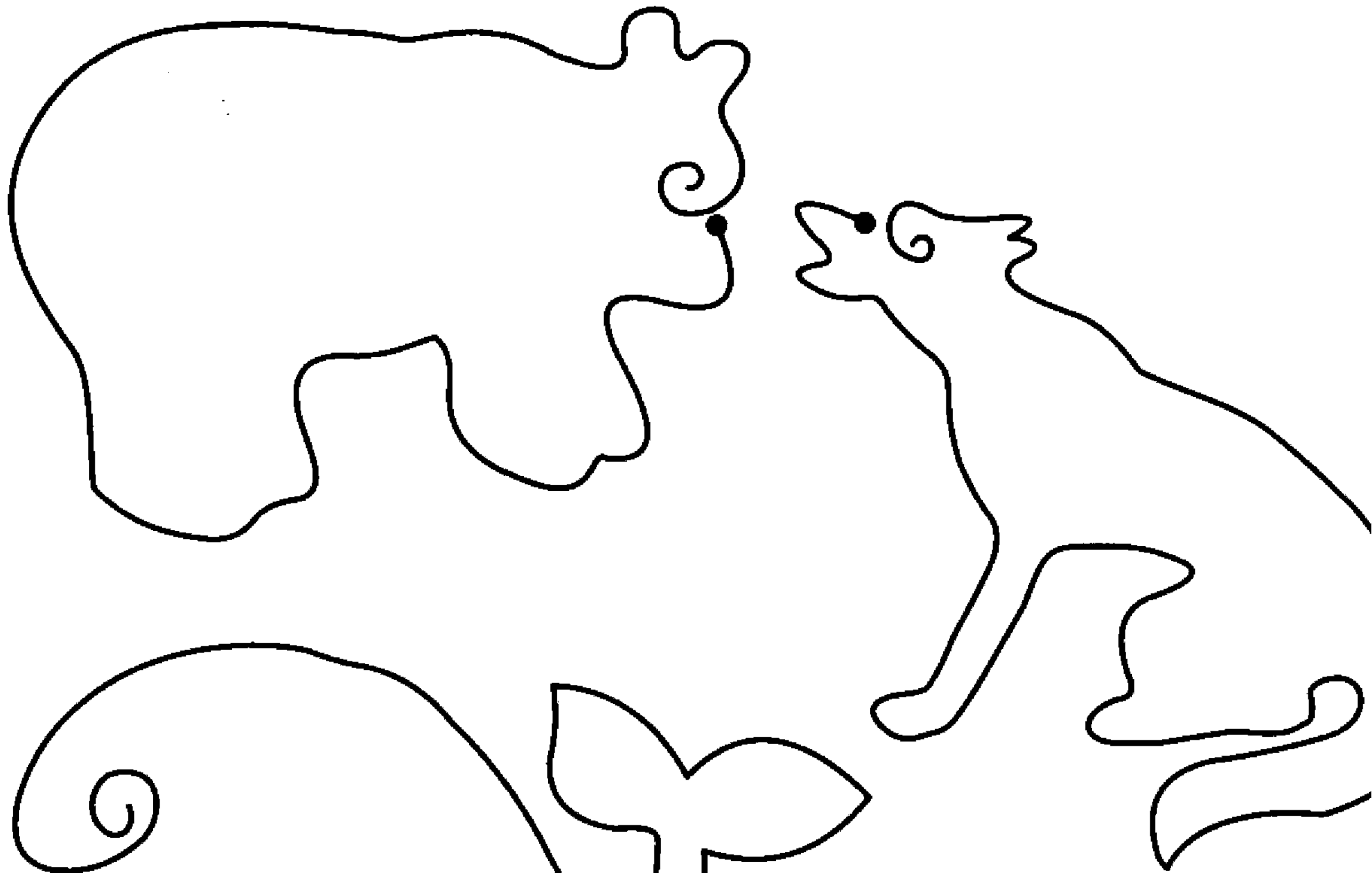

П

Панда



3

1 ↓ 2 ↓

3

1 ↓ 2 ↓

3

1 ↓ 2 ↓

Нарисуй от точки фигуры по образцу и раскрась их.

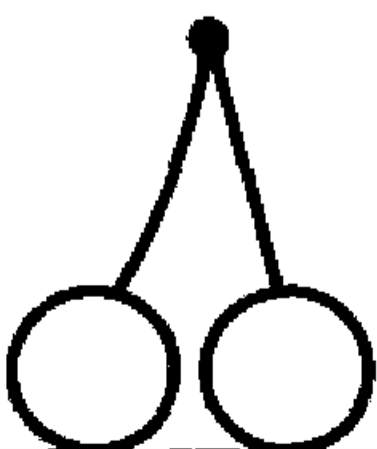
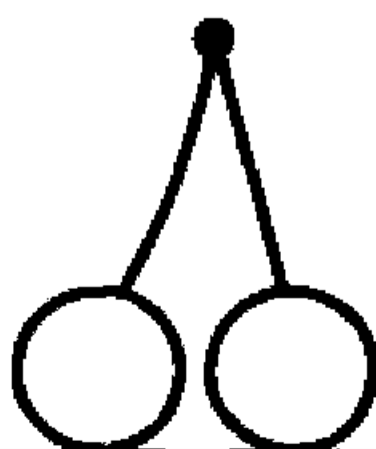
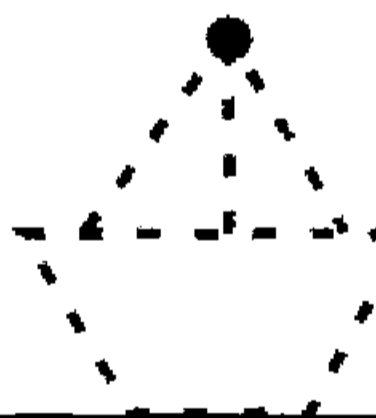
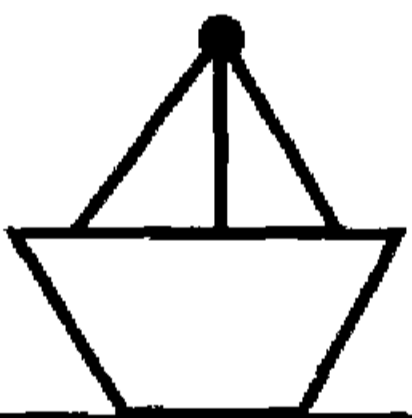
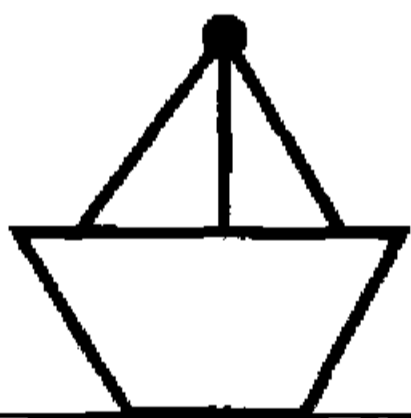
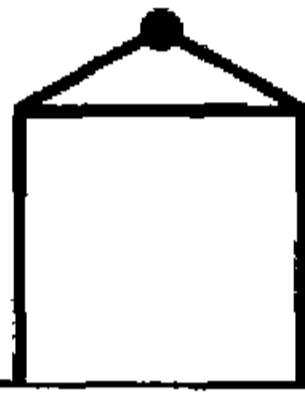
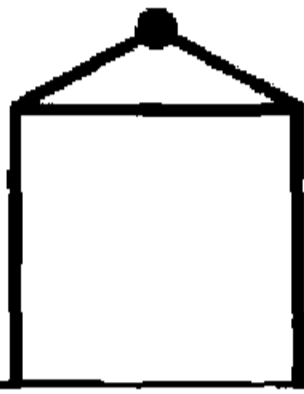
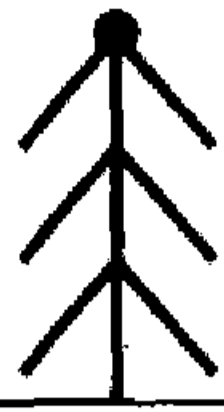
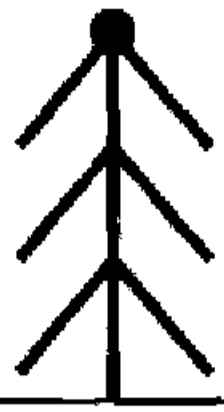

# P

РЫСЬ

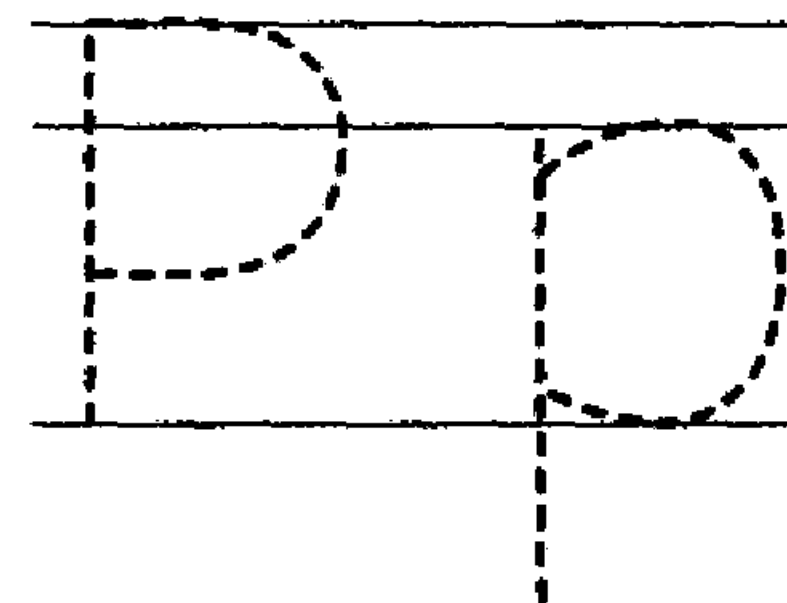
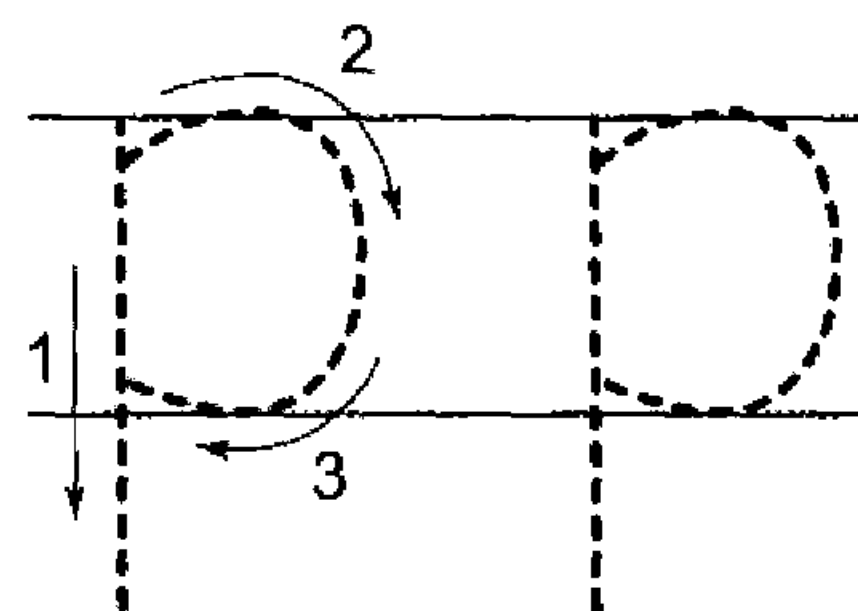
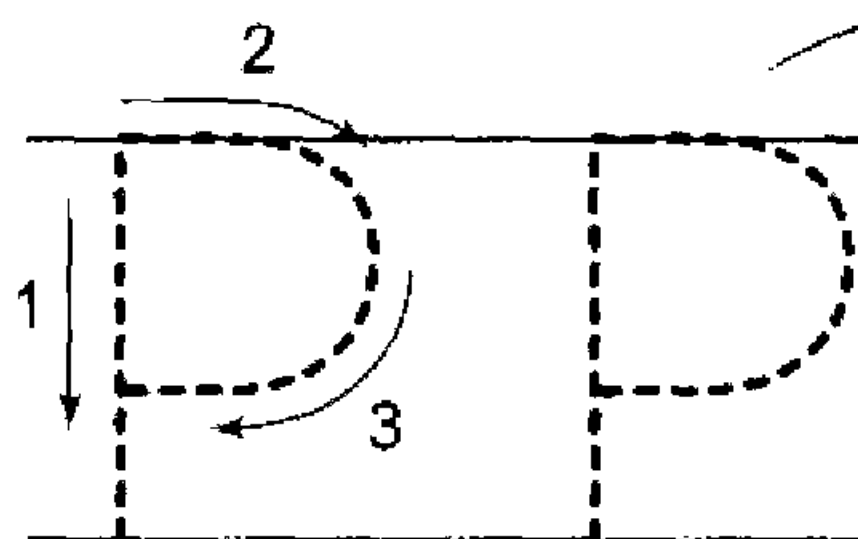
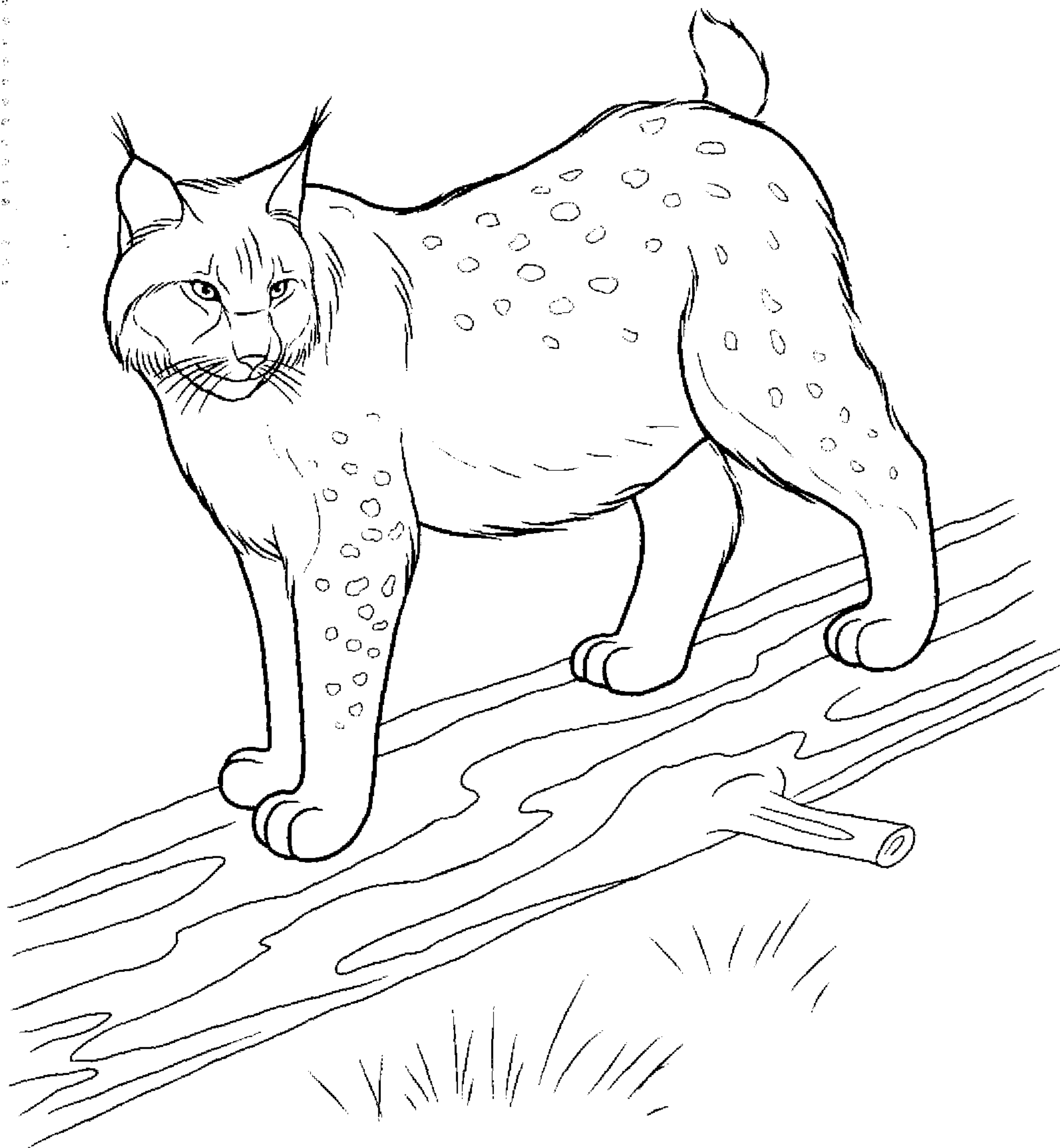

Обведи рисунки точно по пунктирной линии и раскрась их.

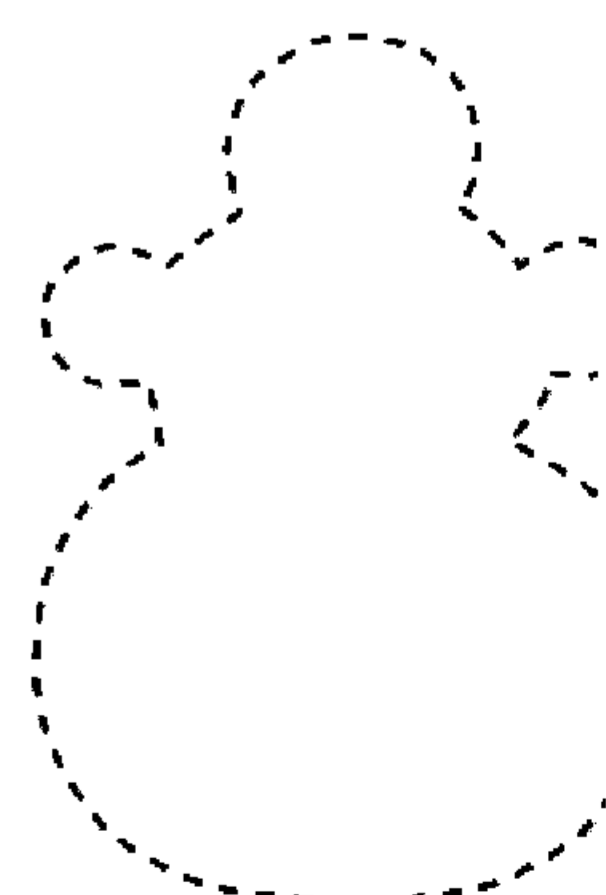
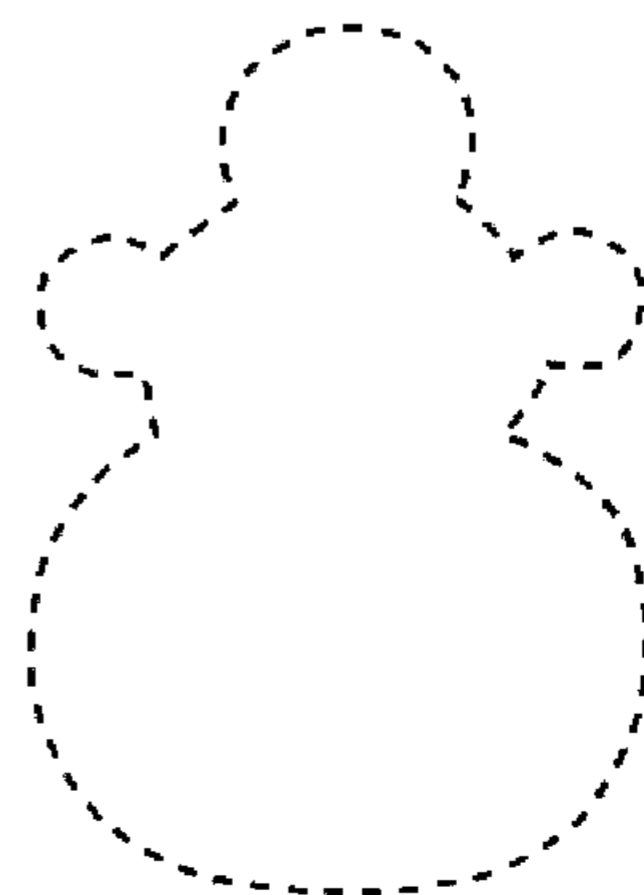
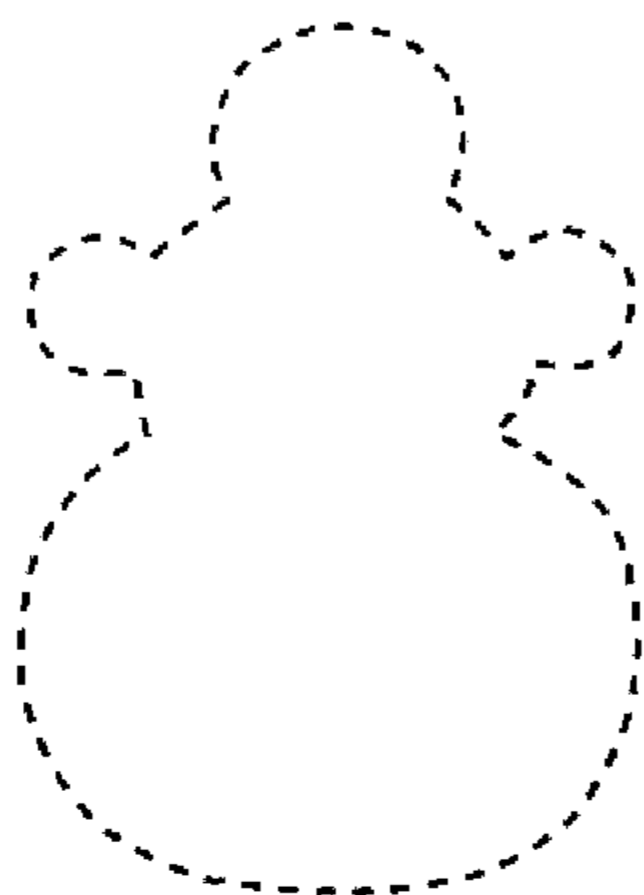
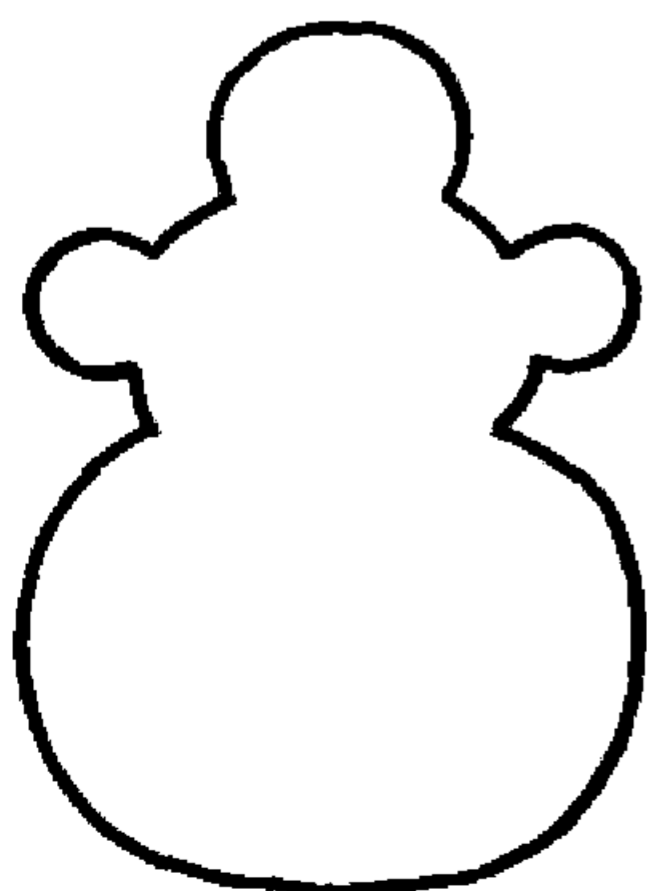
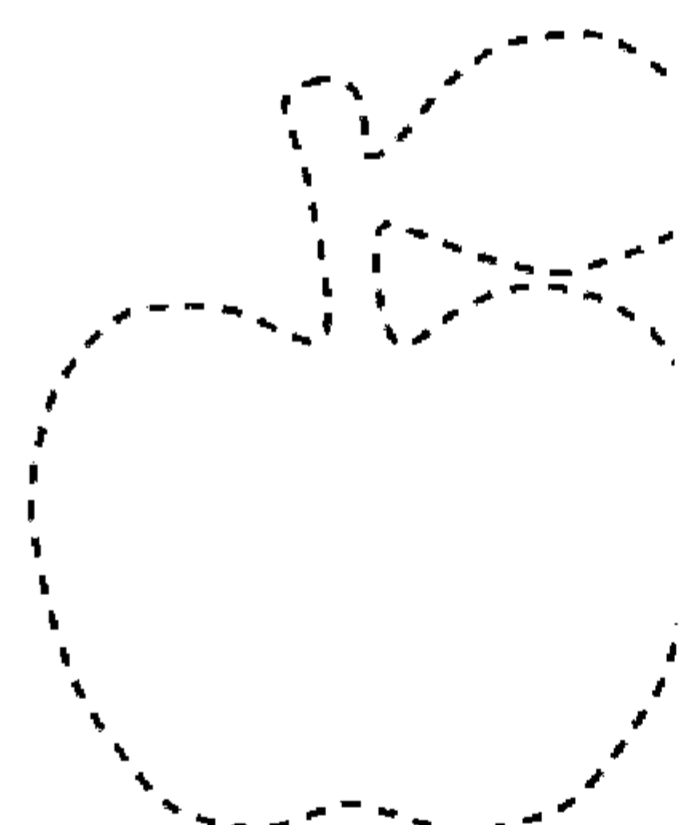
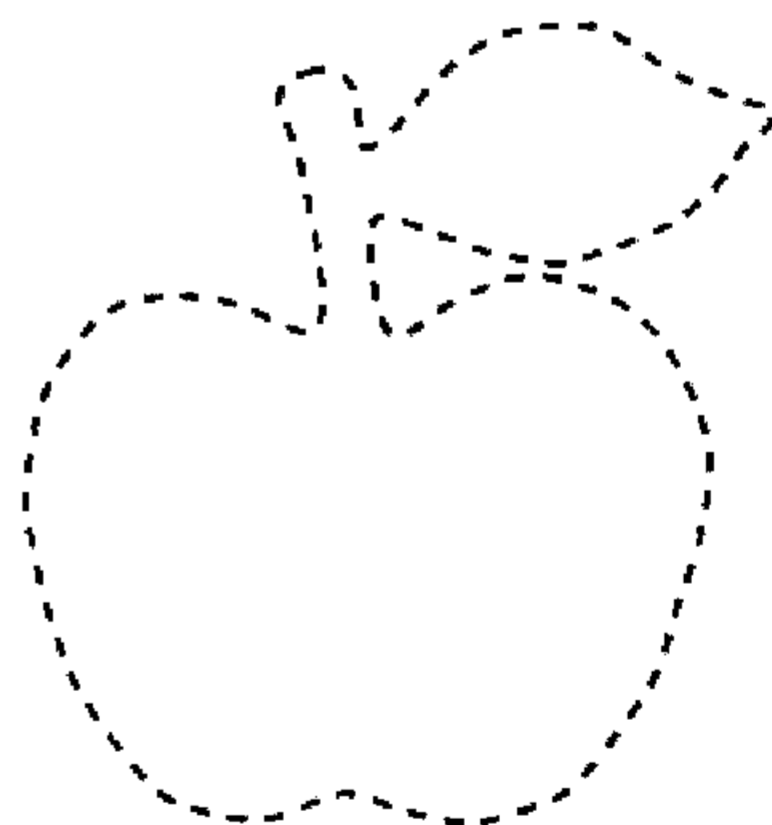
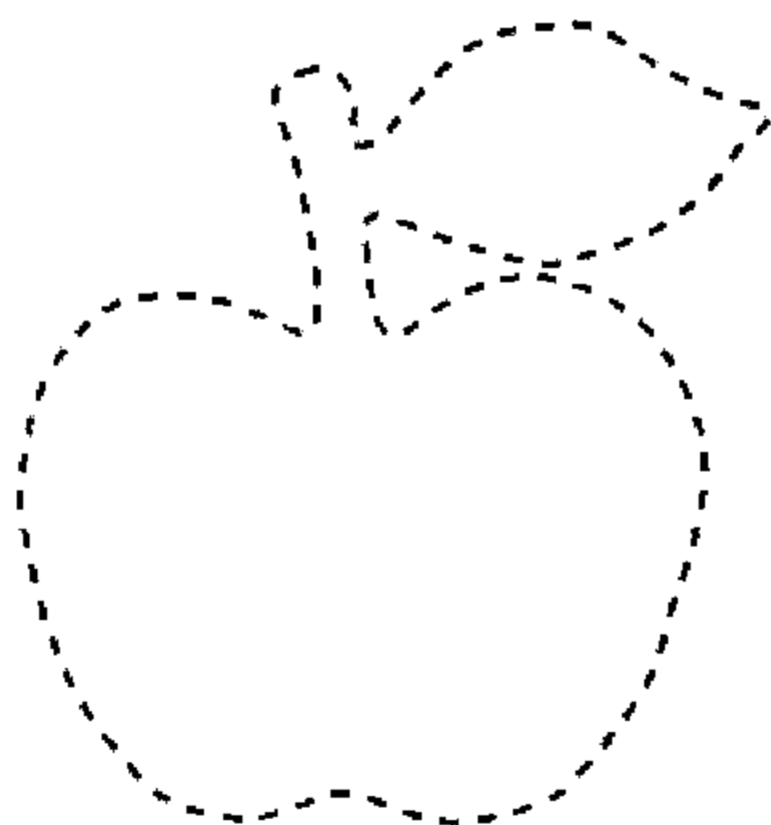
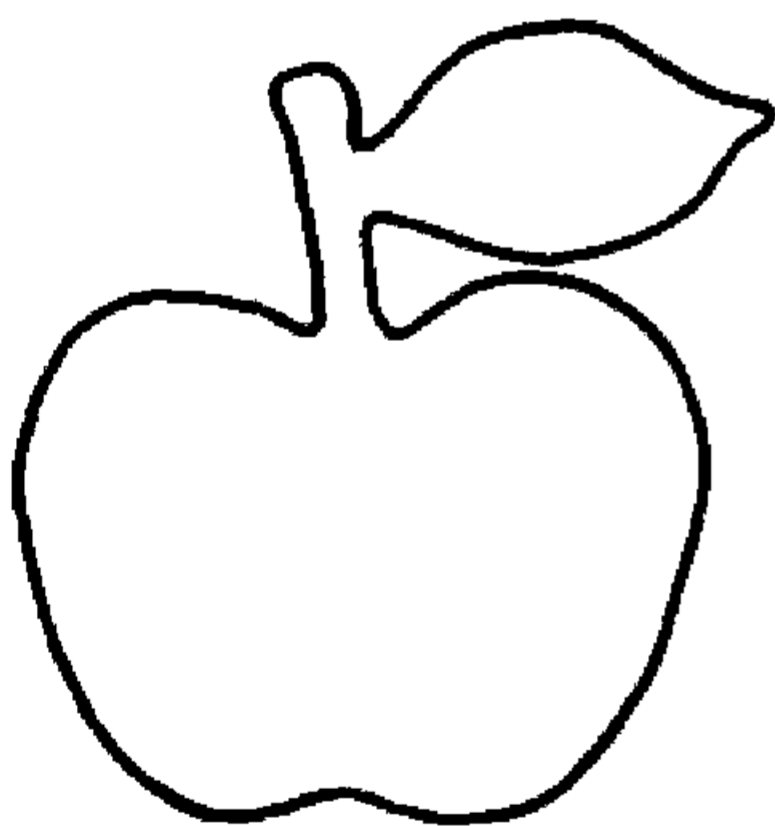
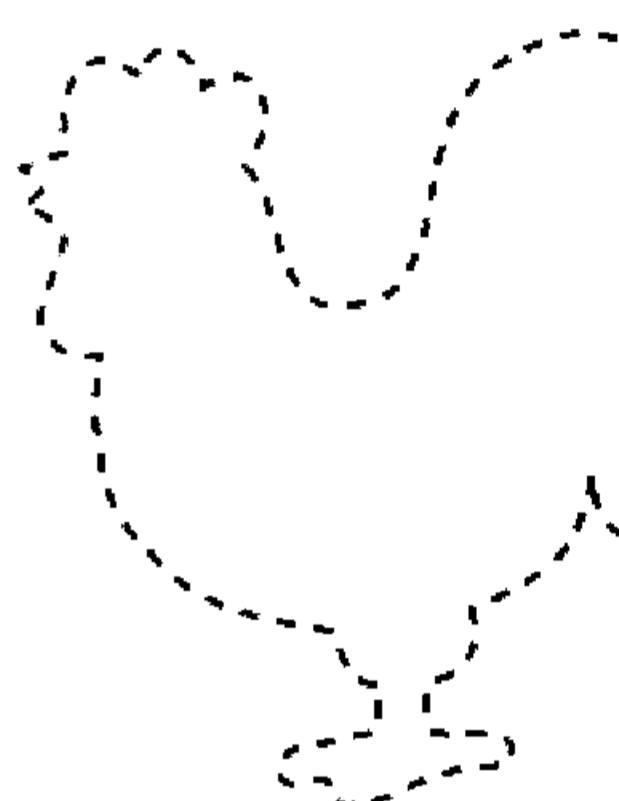
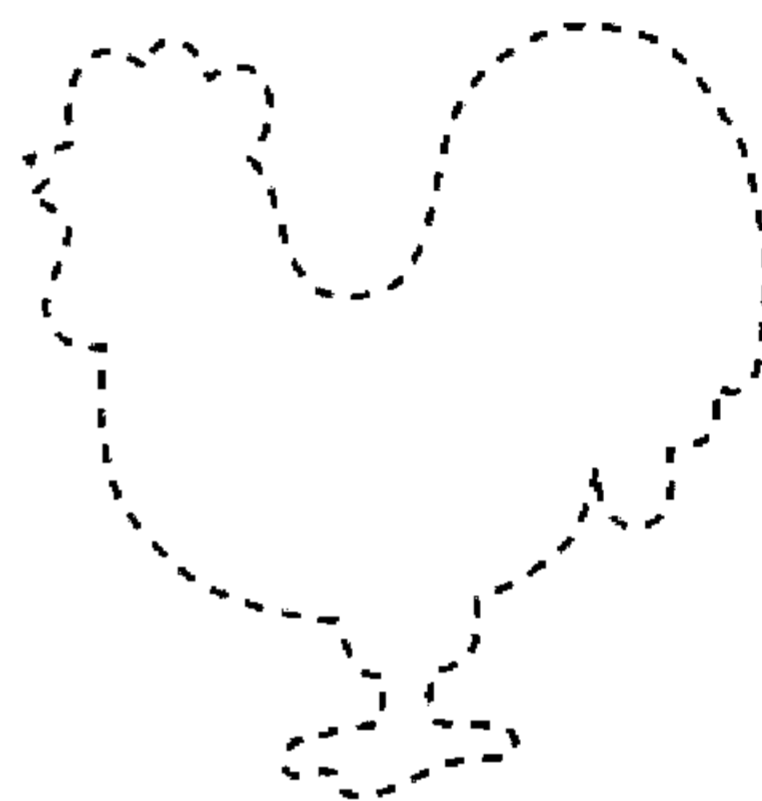
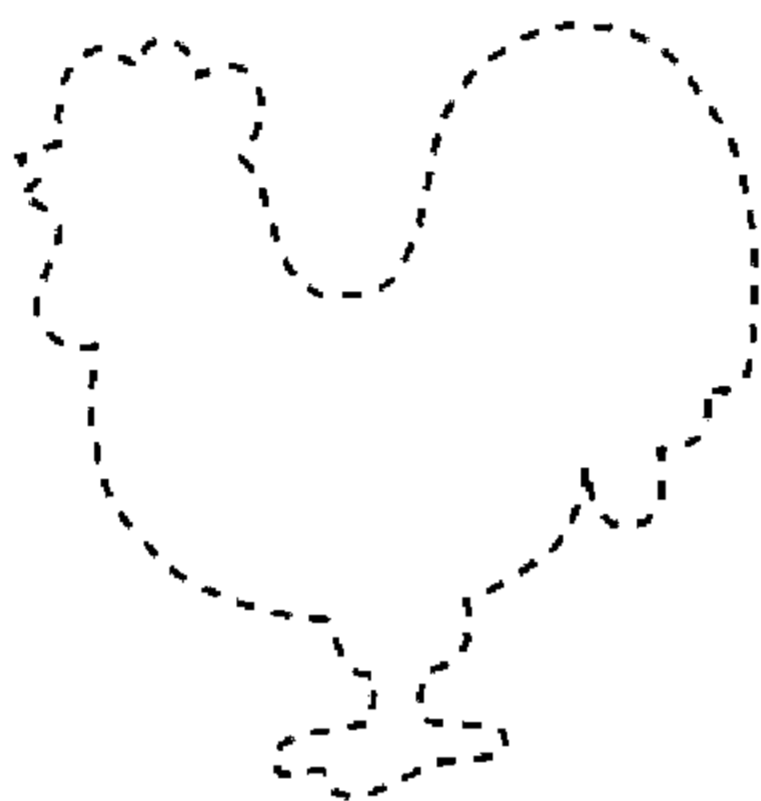
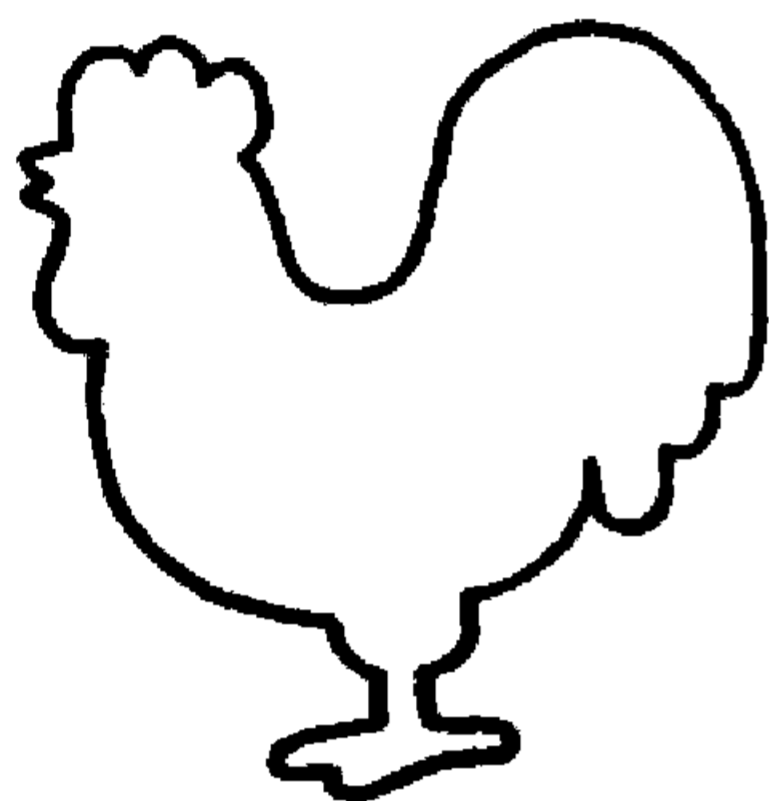
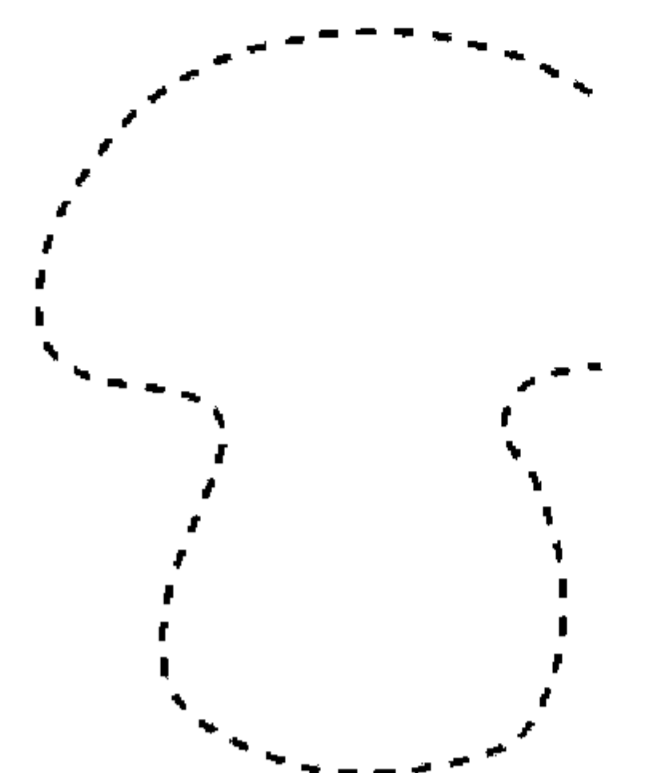
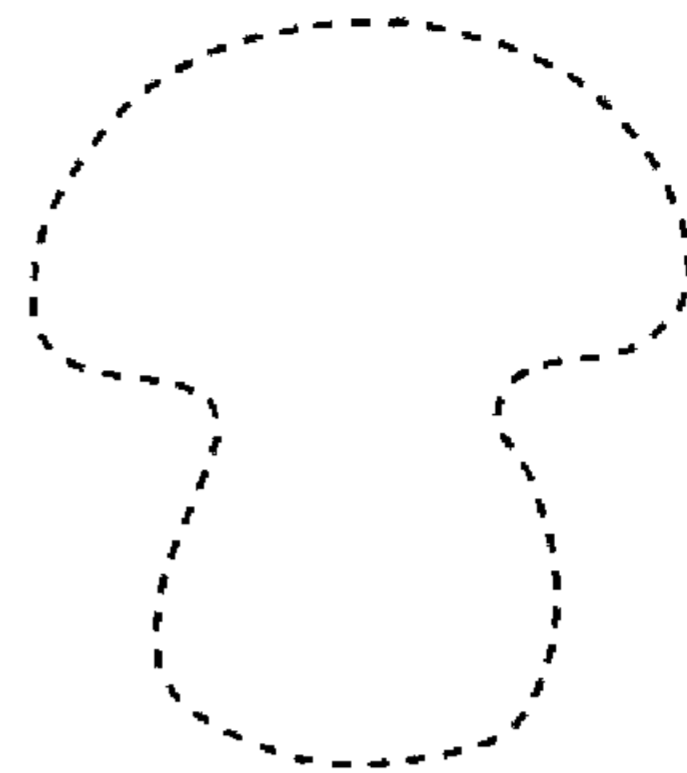
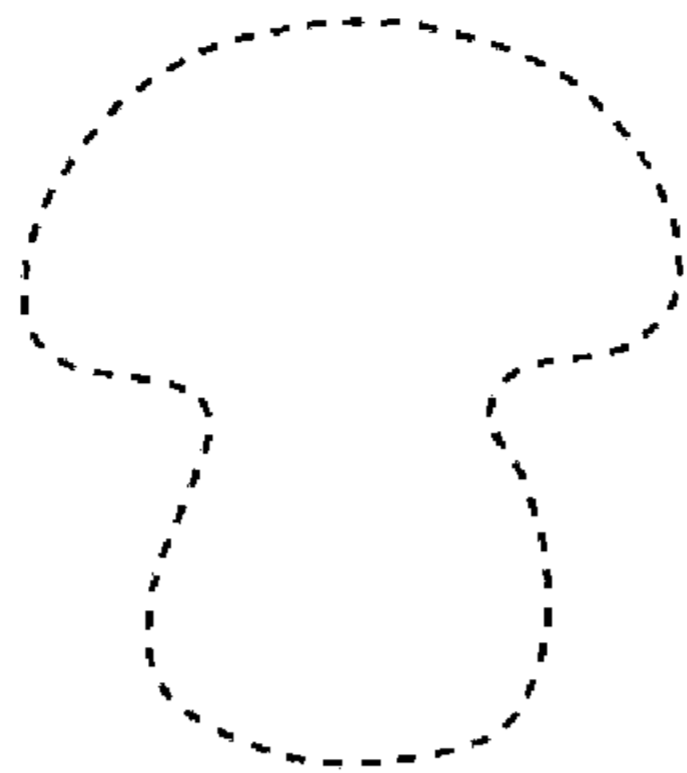
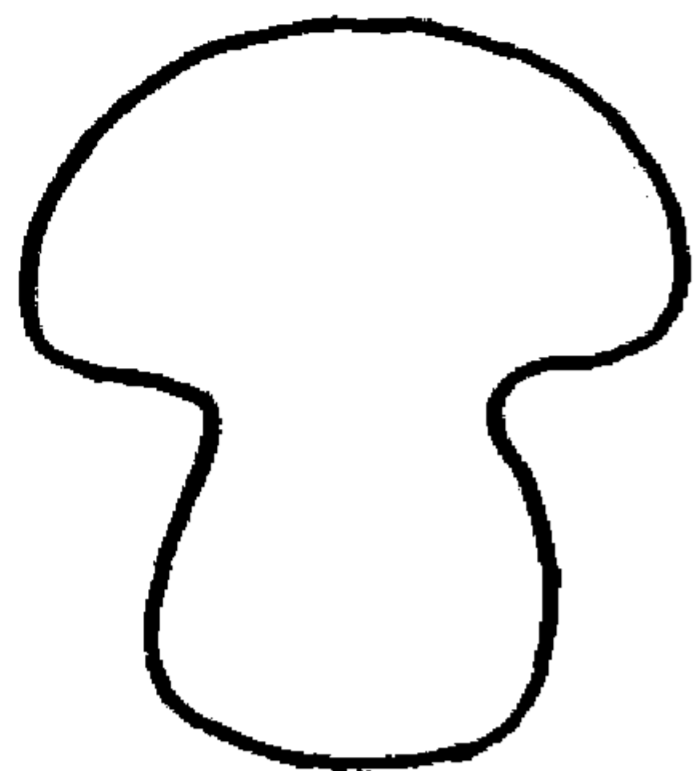

С

Слон

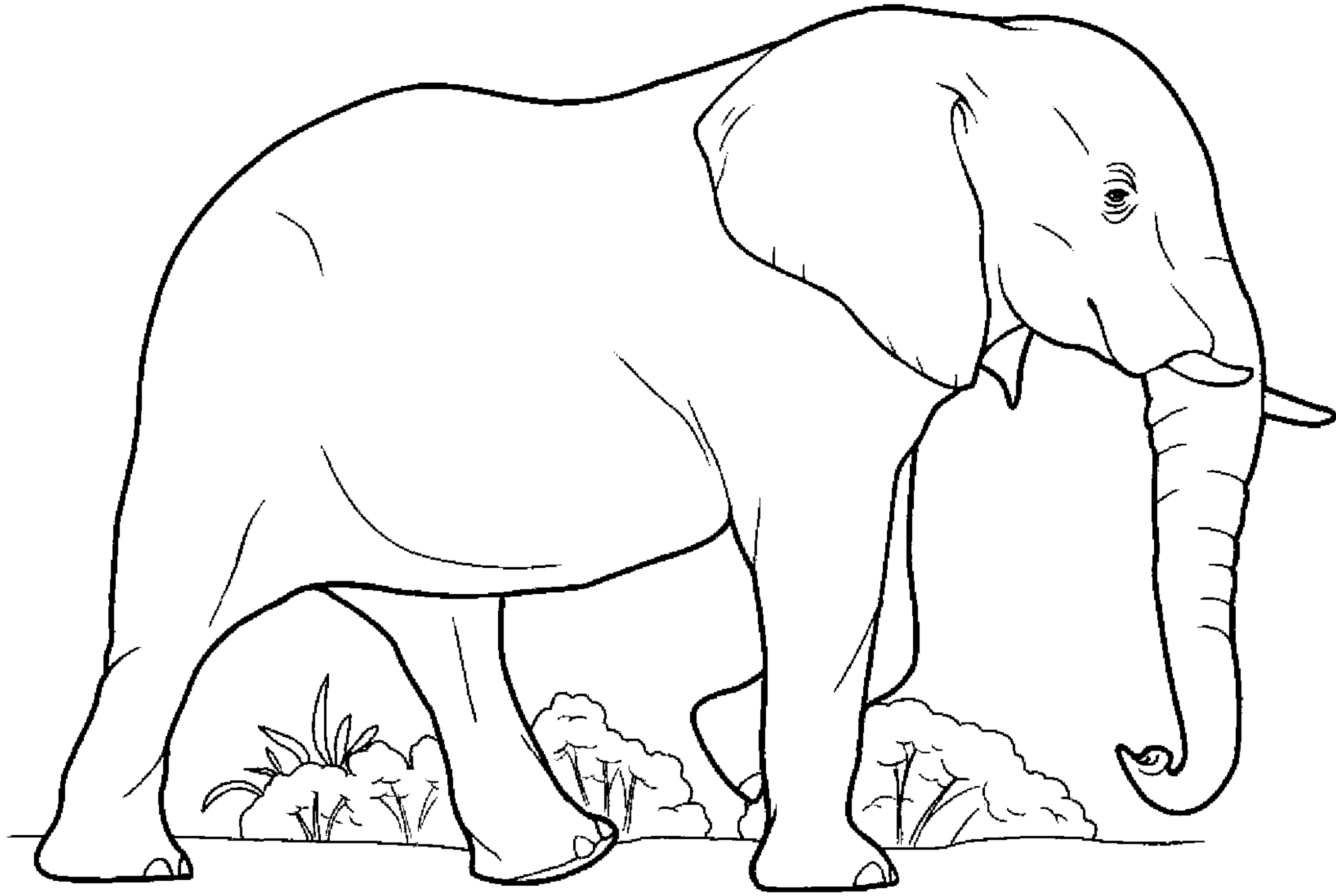
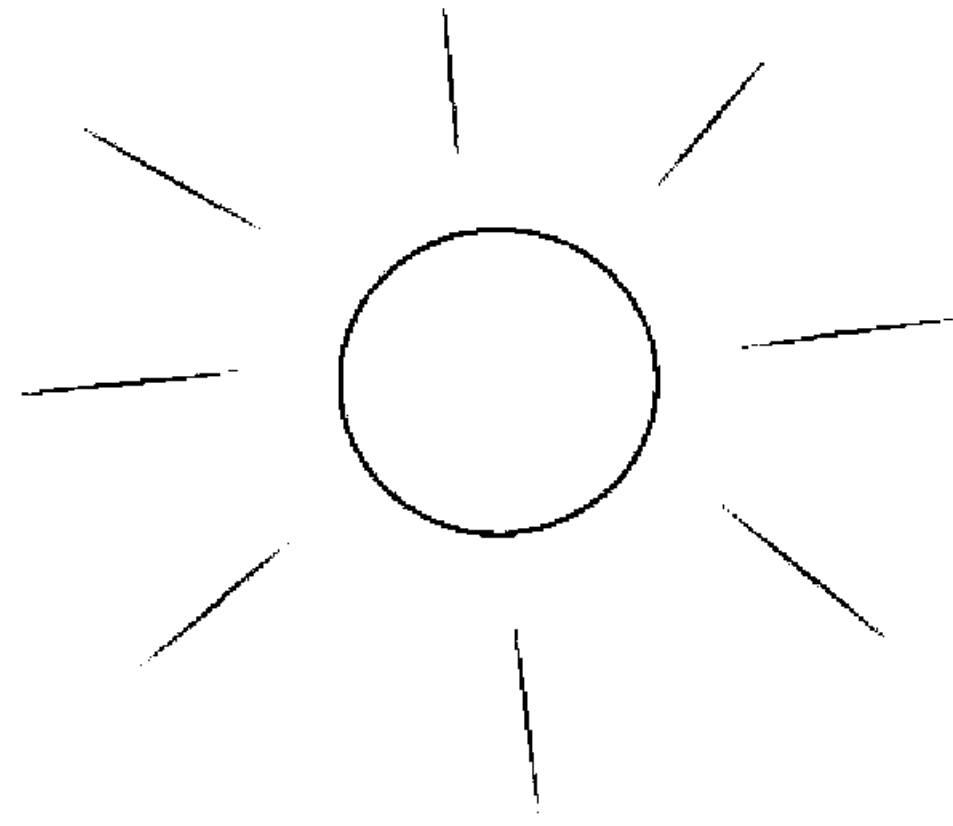

Handwriting practice section consisting of three rows of horizontal lines. Each row contains a dashed uppercase letter 'C' for tracing. The first row includes numbered arrows (1, 2, 3) indicating the stroke order: 1 is a counter-clockwise curve from top to bottom, 2 is the bottom curve, and 3 is the top curve. The second and third rows contain dashed 'C's without stroke order guides.

Дорисуй вторые половинки ковриков и раскрась их.

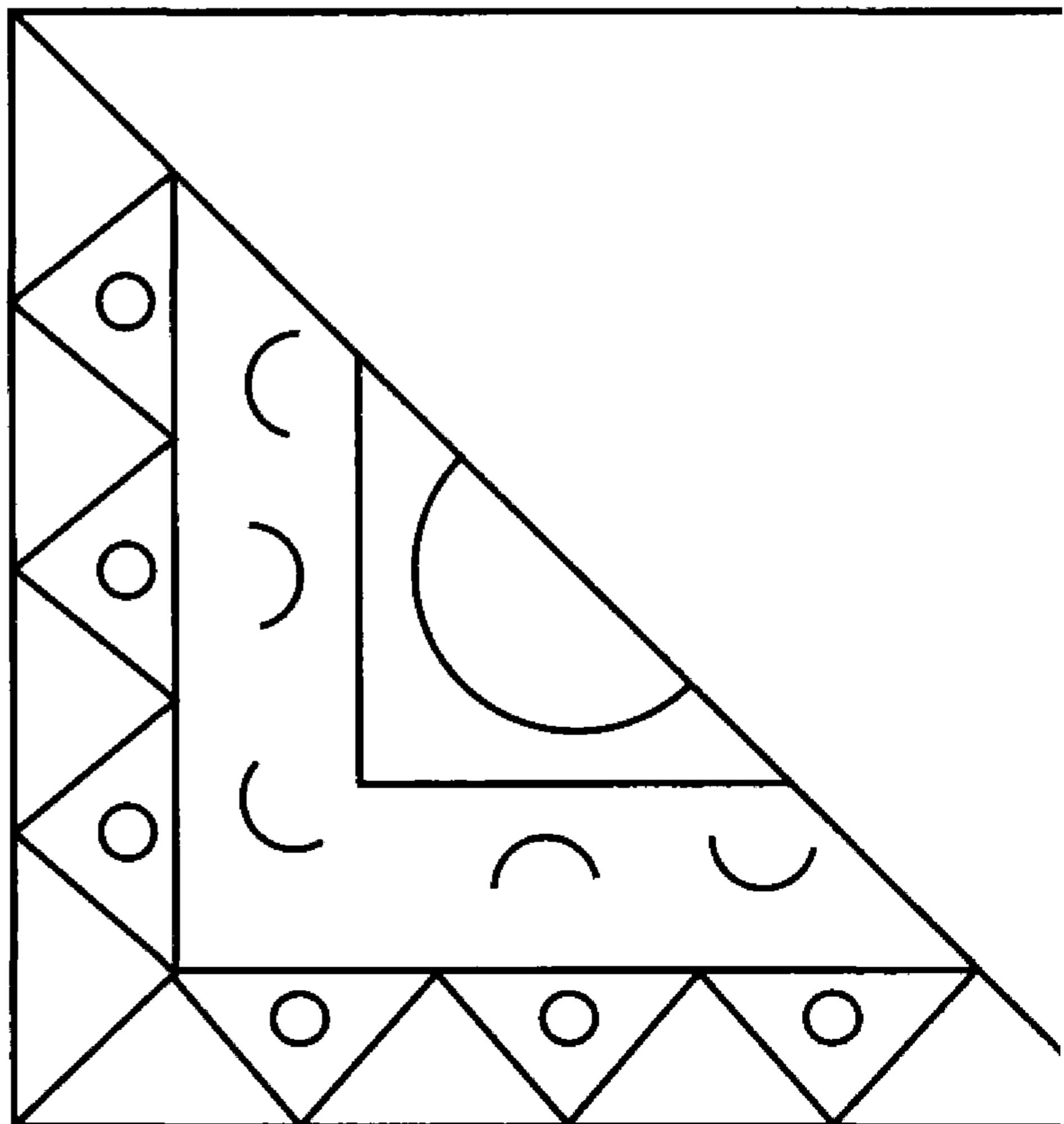
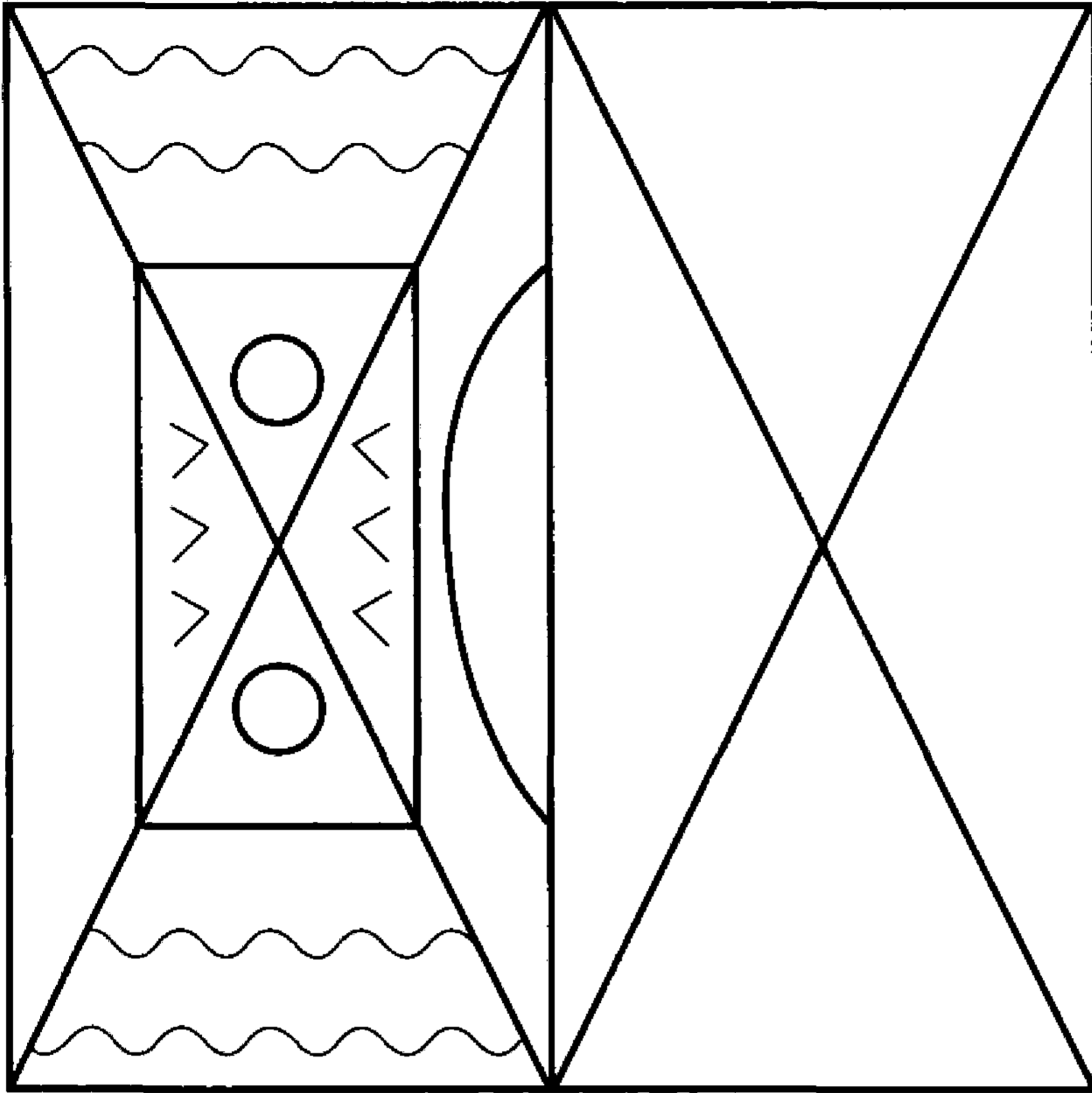



# T

Тигр



2

1

2

1

1

Выполни штриховку этих предметов параллельными линиями, оставляя окошечки незаштрихованными. Раскрась картинки.

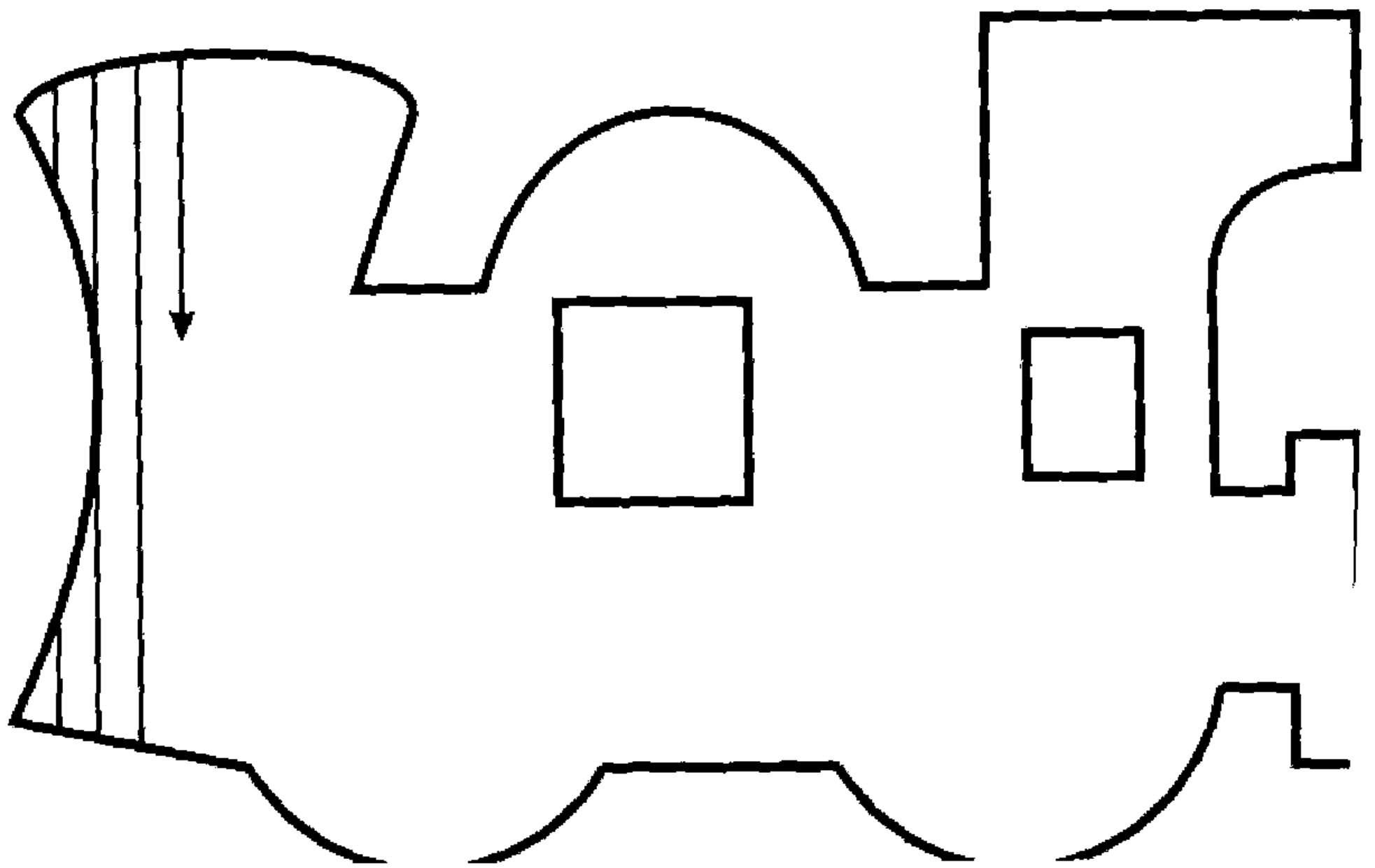
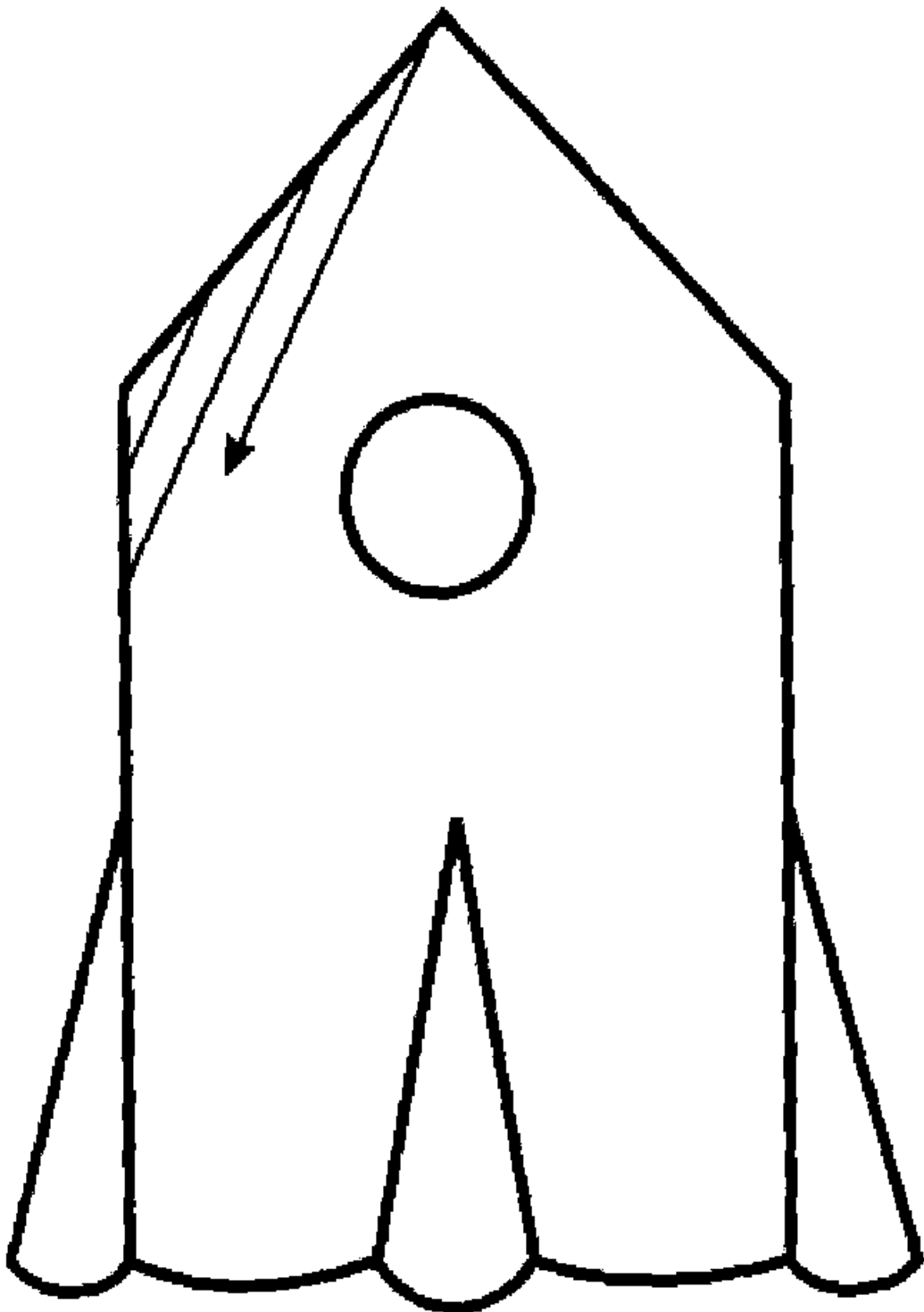
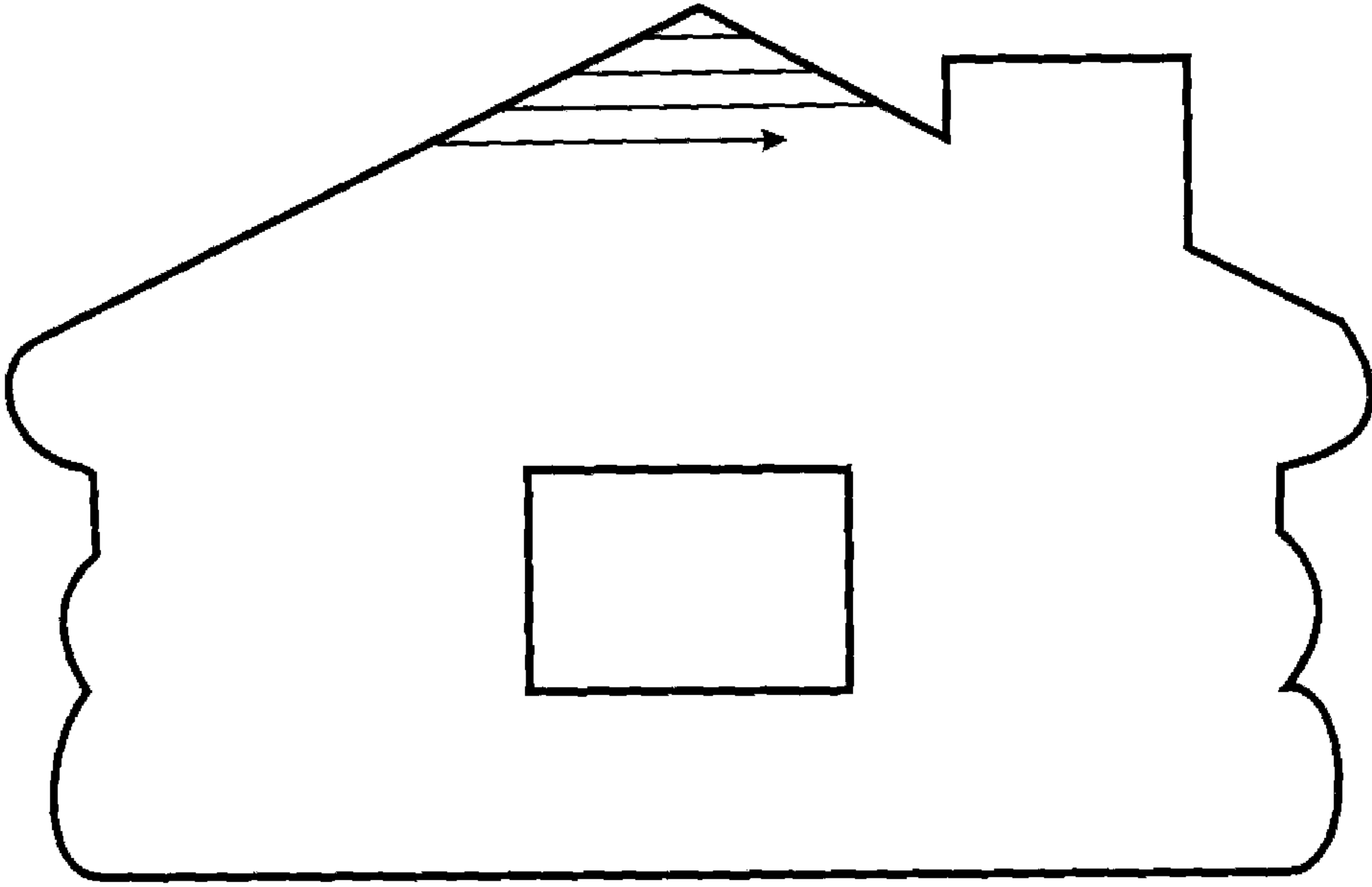

# у

Утка

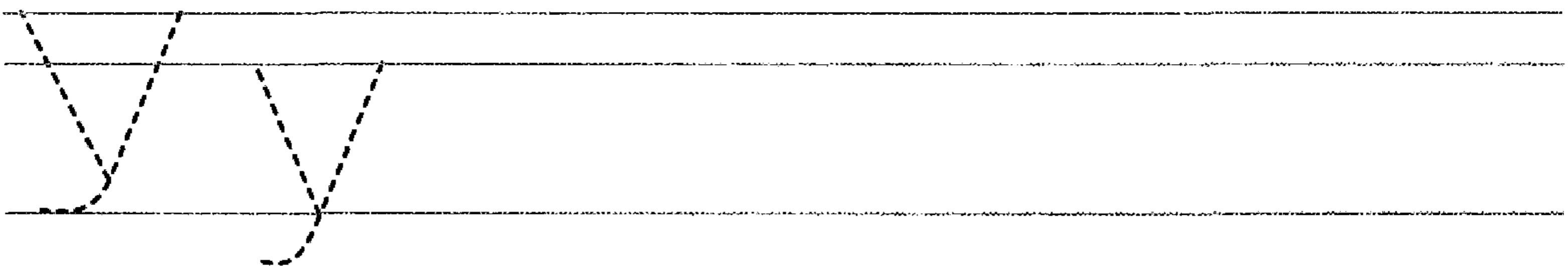
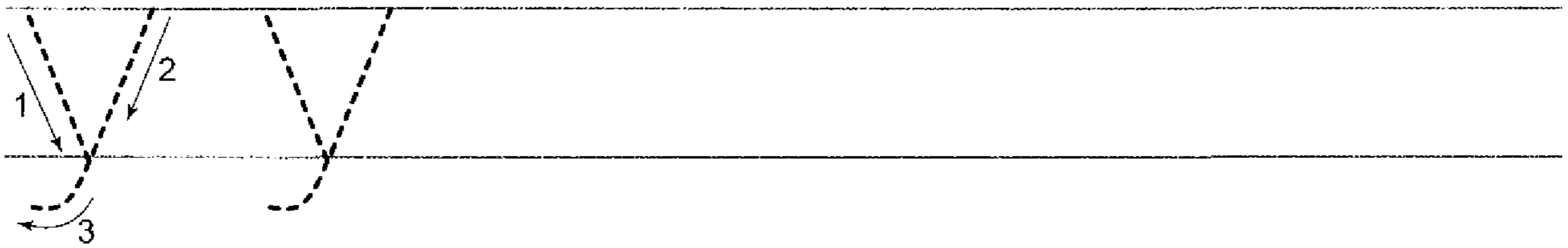
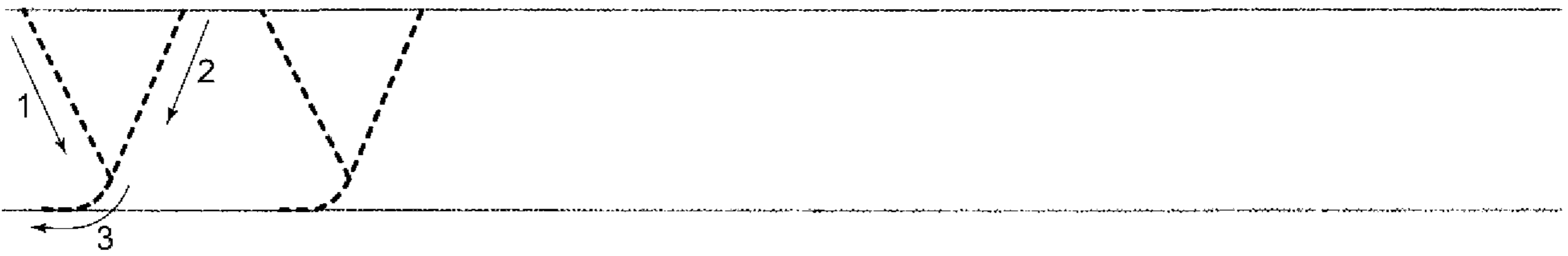
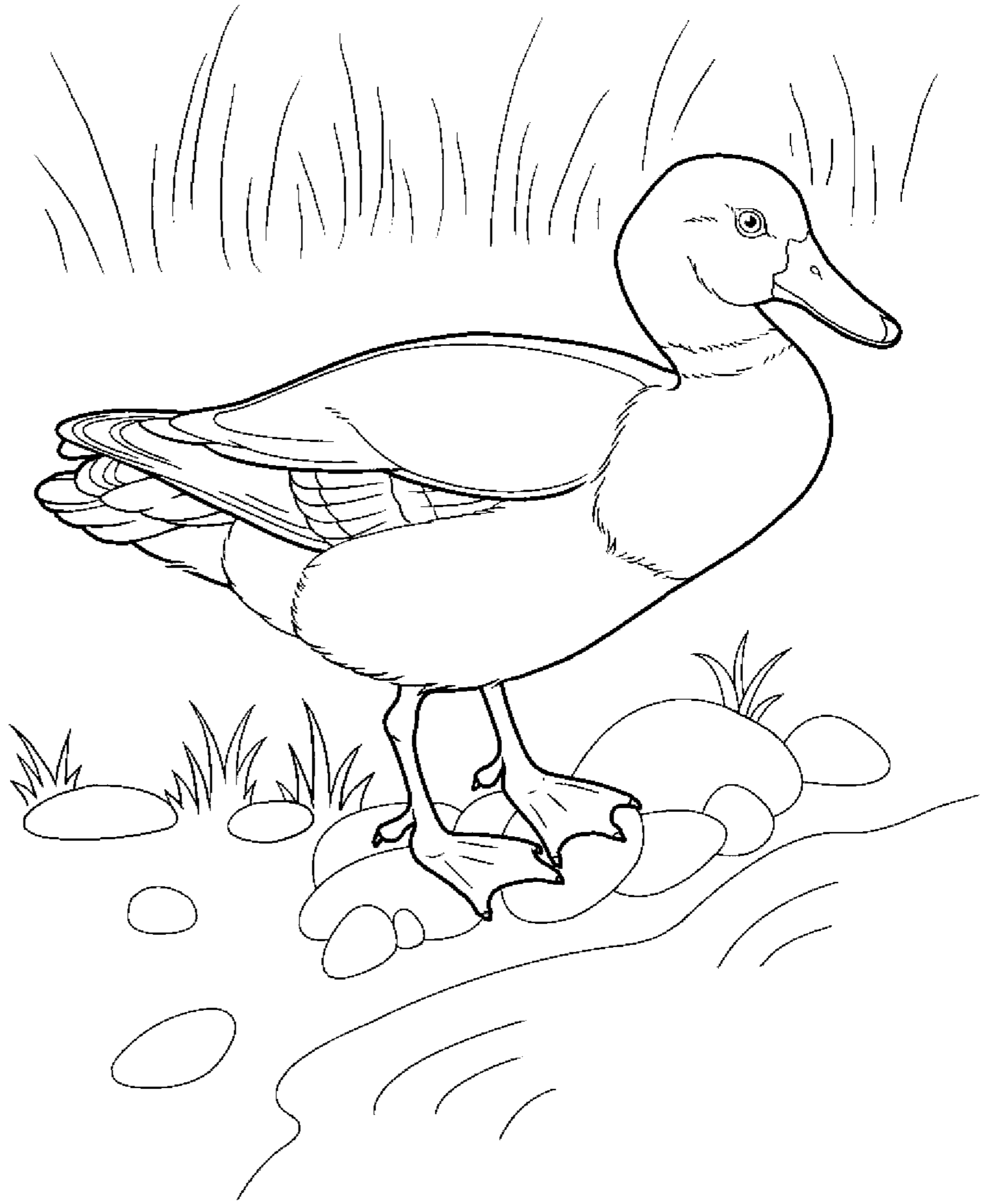

Обведи рисунки точно по пунктирной линии, не отрывая карандаш от бумаги.

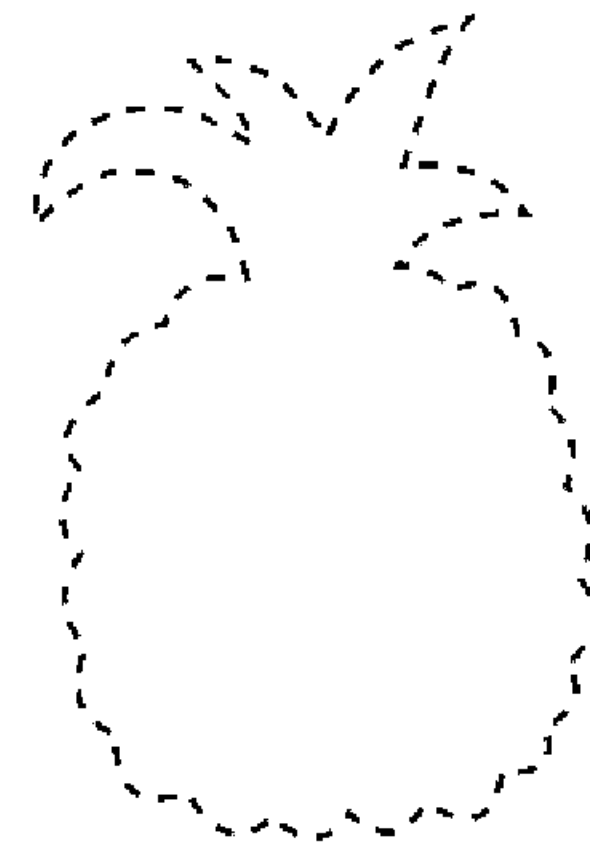
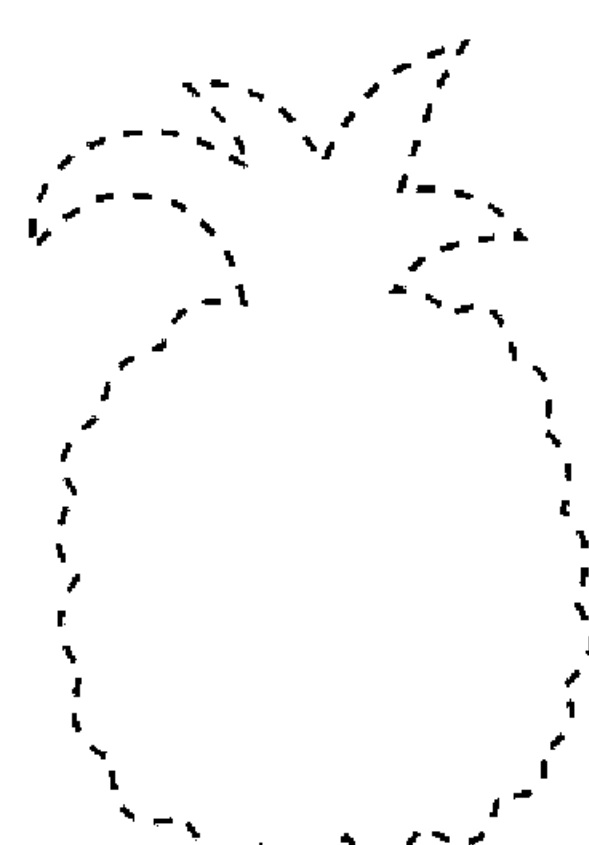
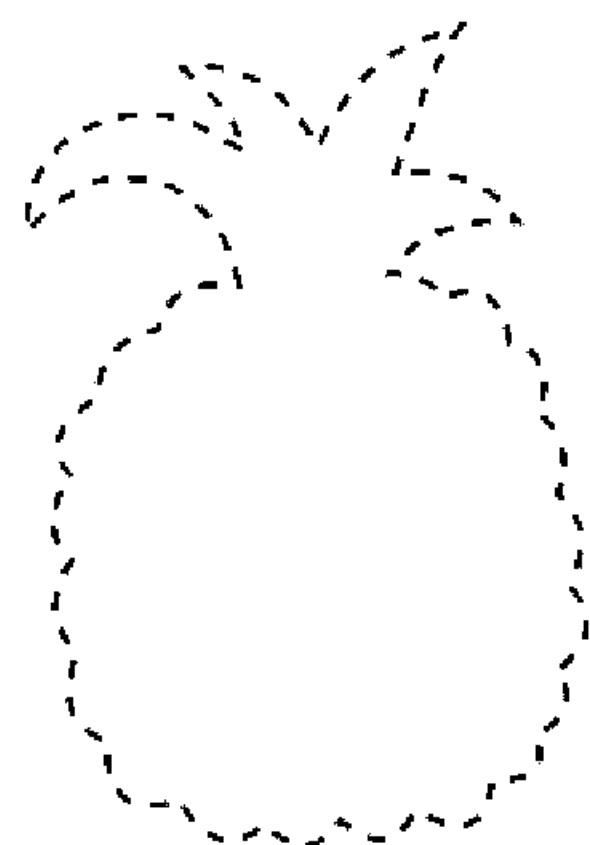
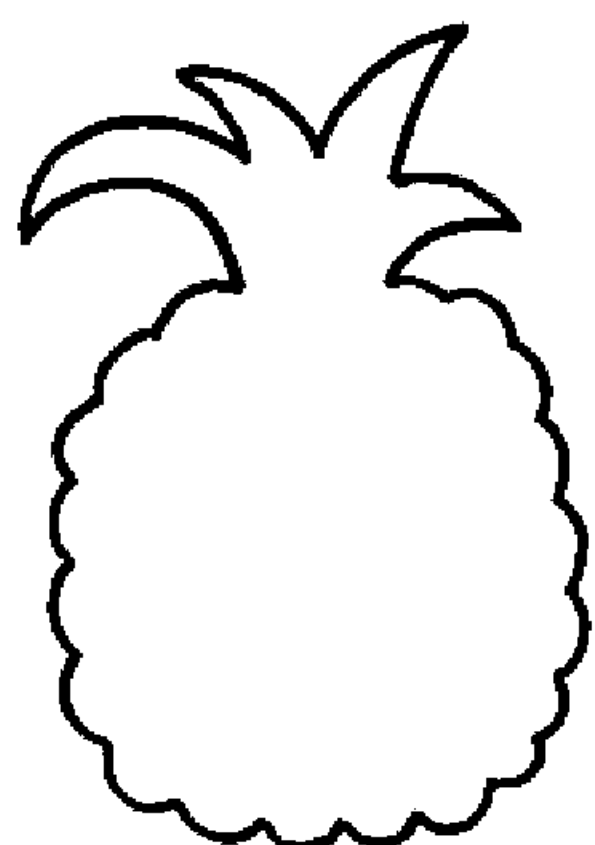
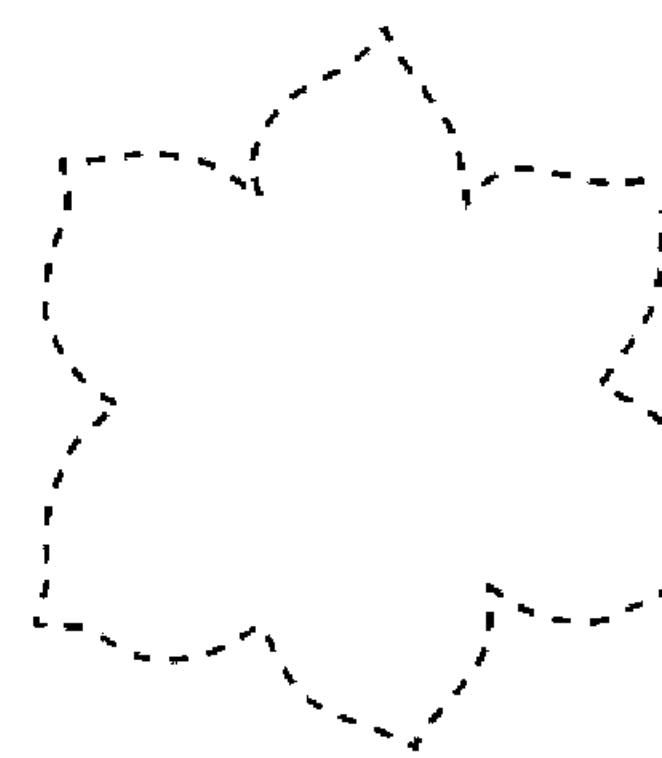
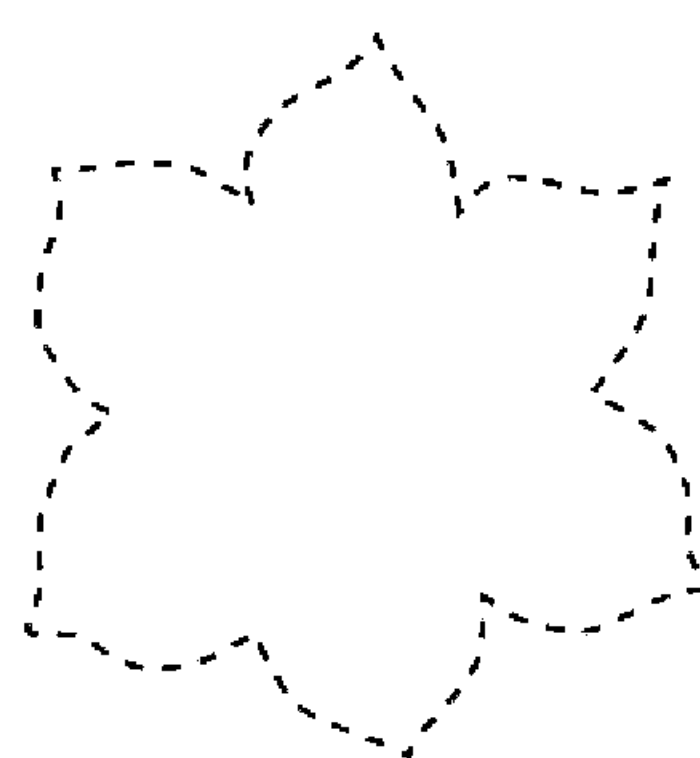
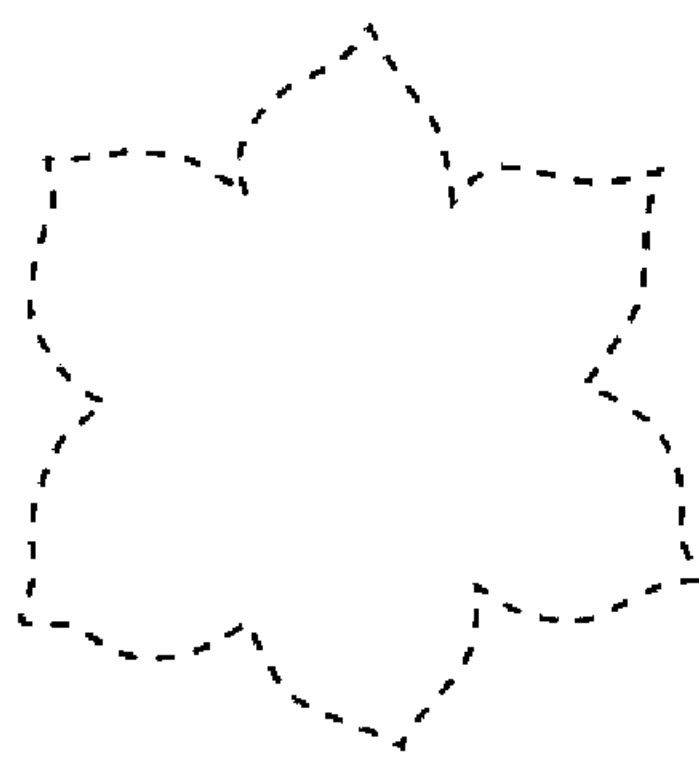
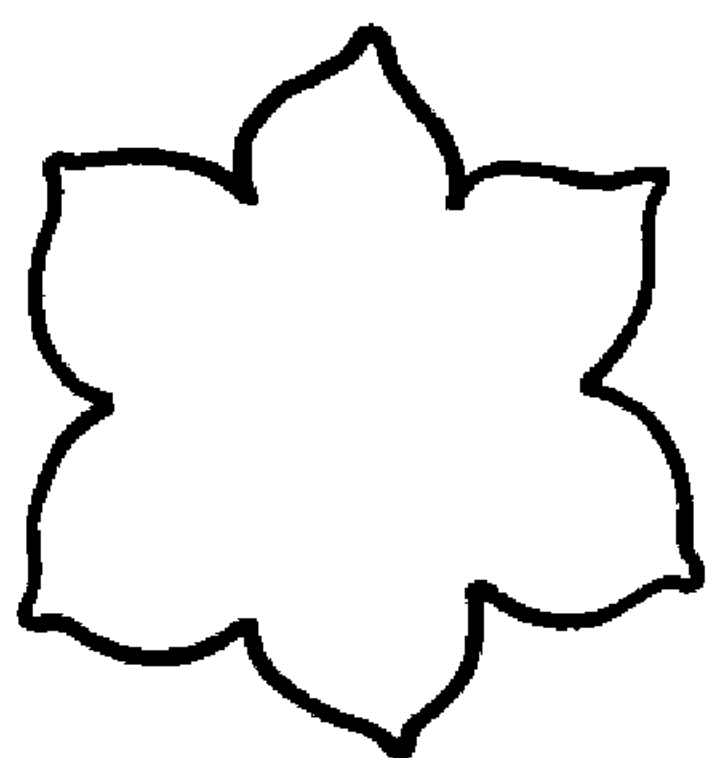
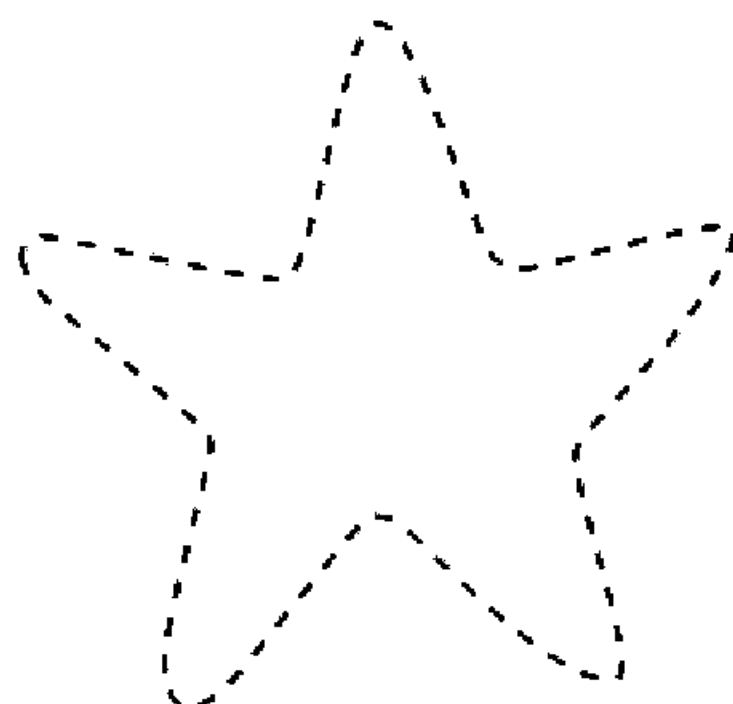
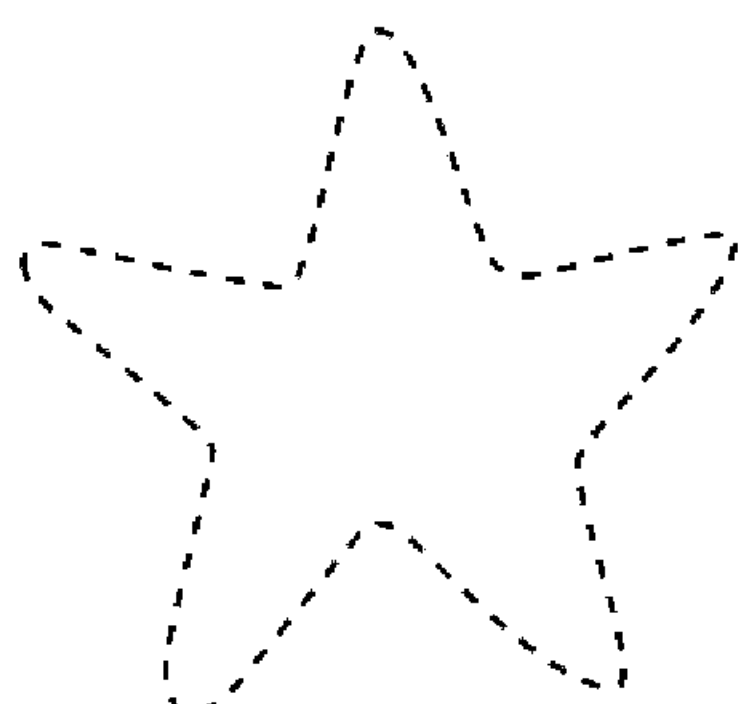
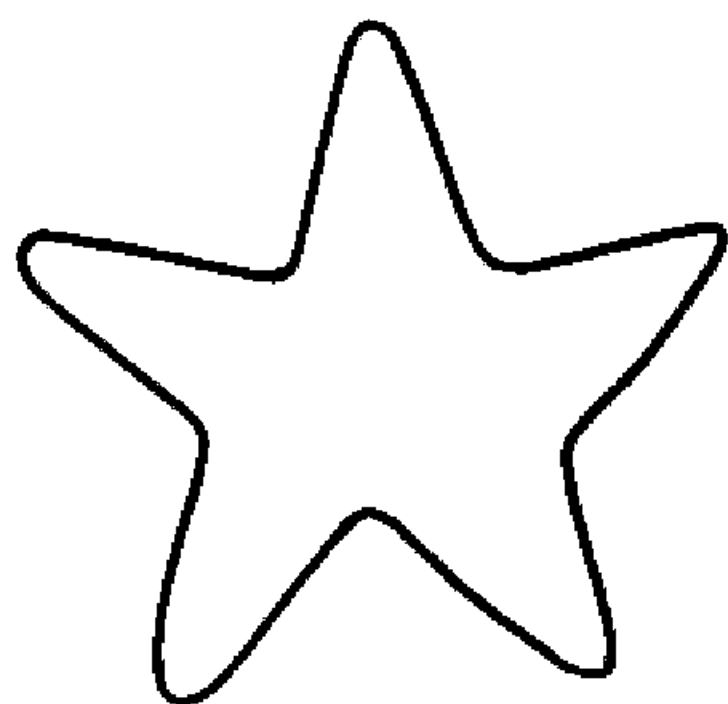
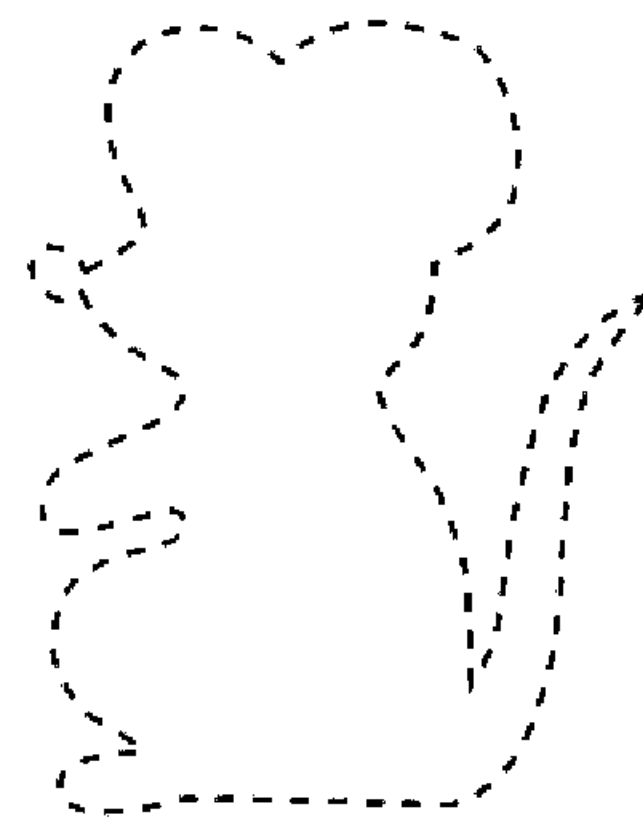
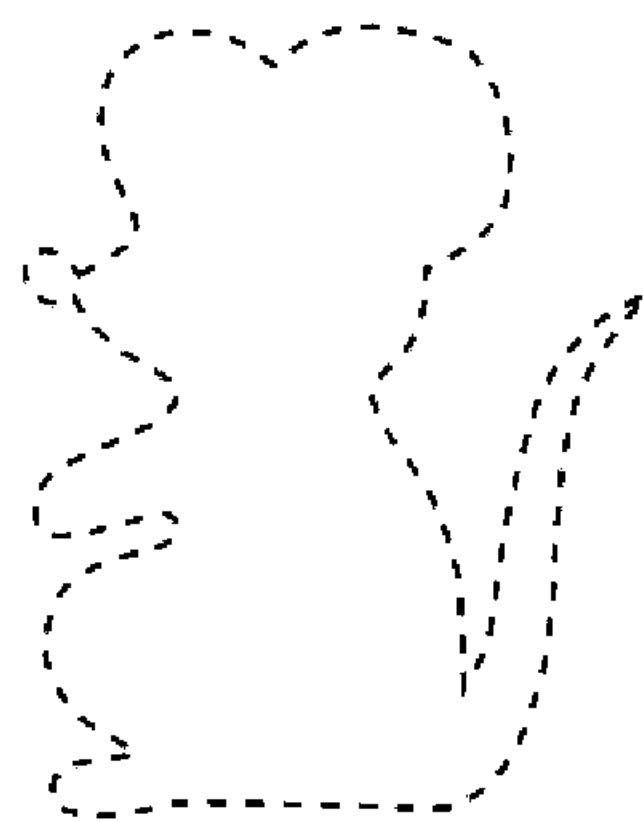
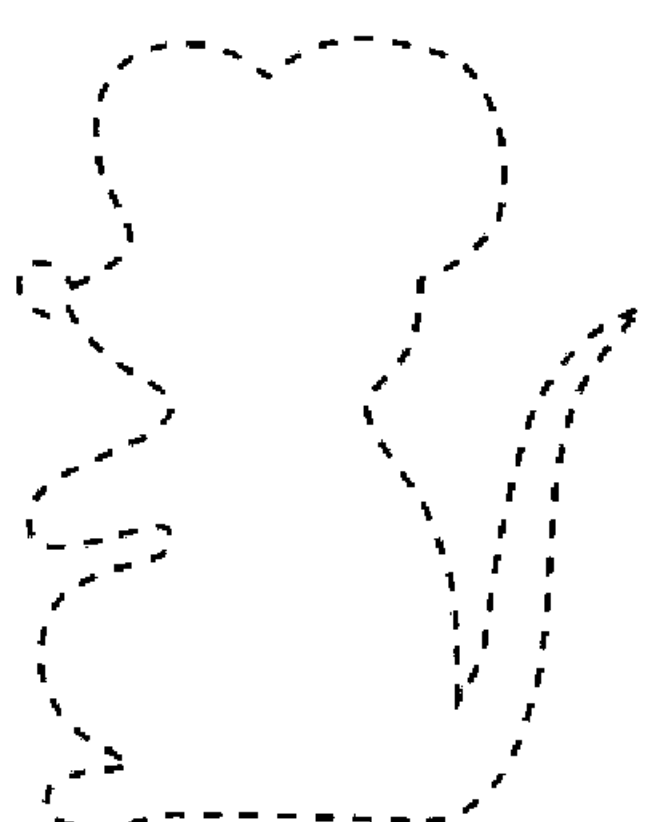



Проведи карандашом точно по линиям, постарайся не отрывать карандаш от бумаги. Раскрась картинки.

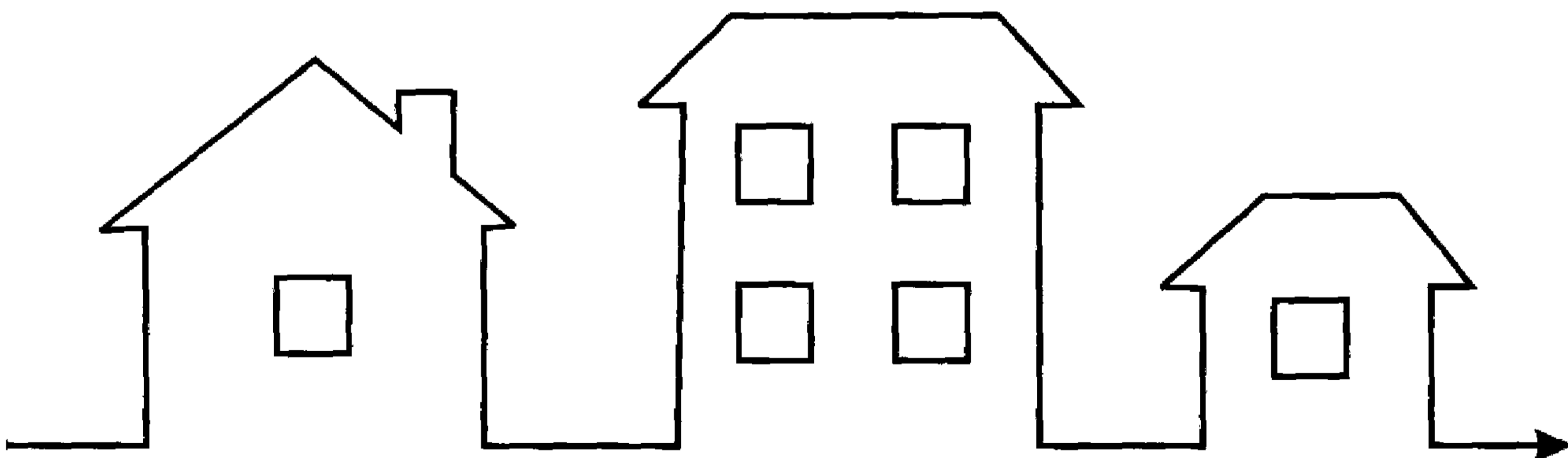
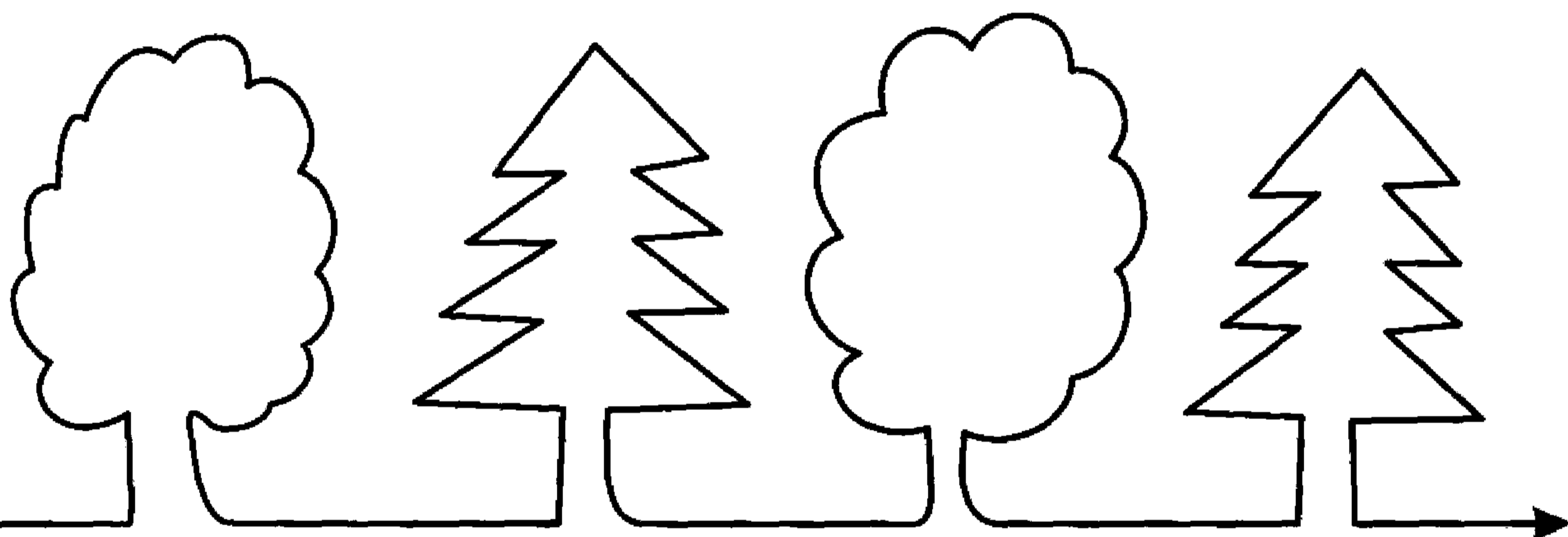
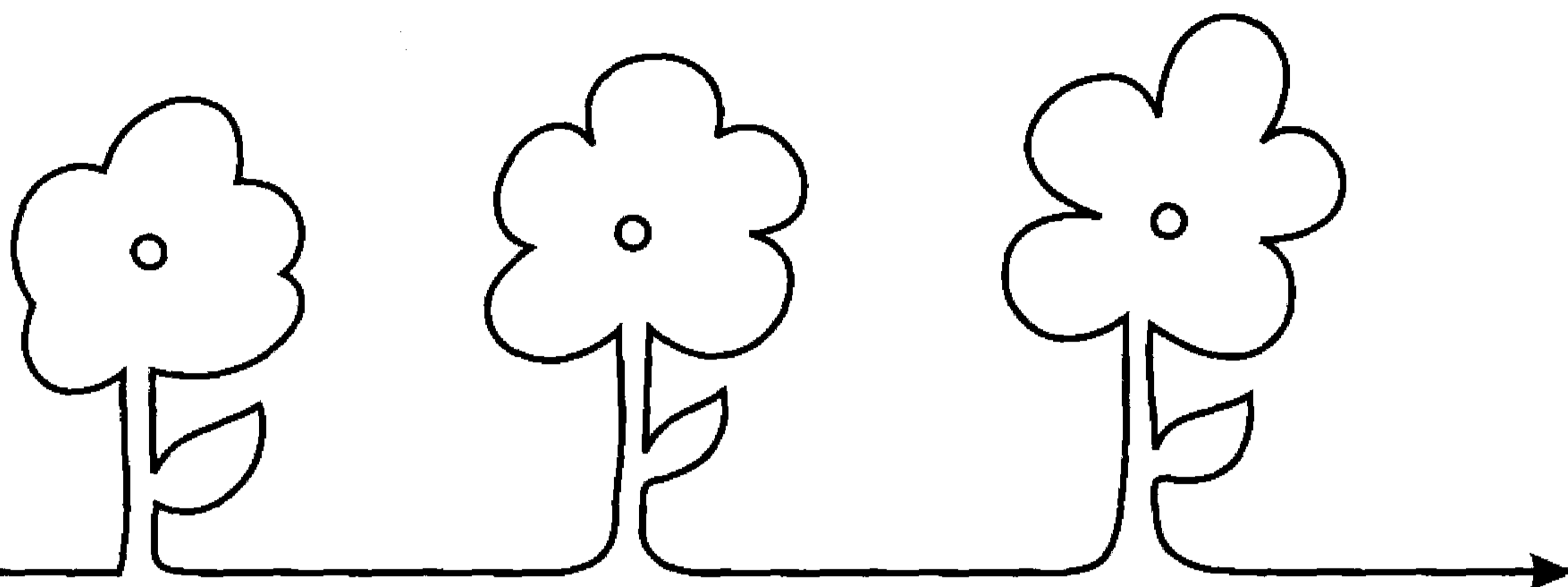

# X

Хамелеон

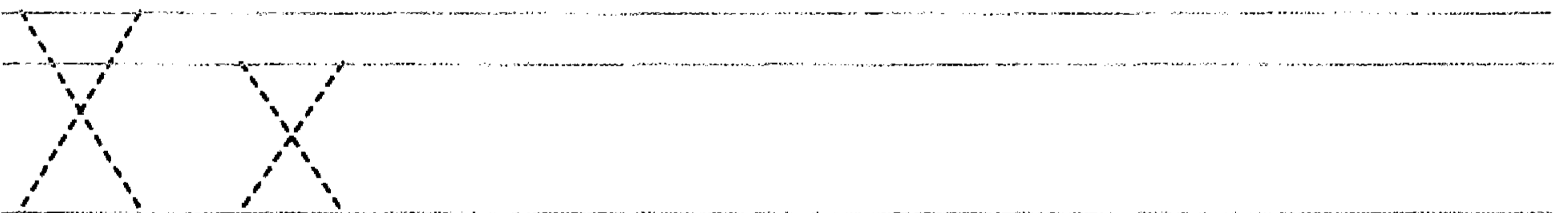
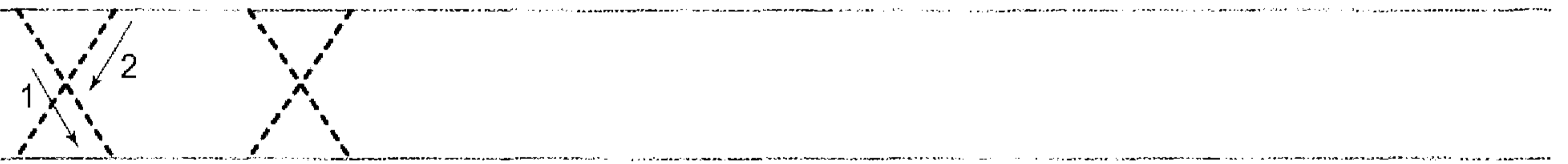
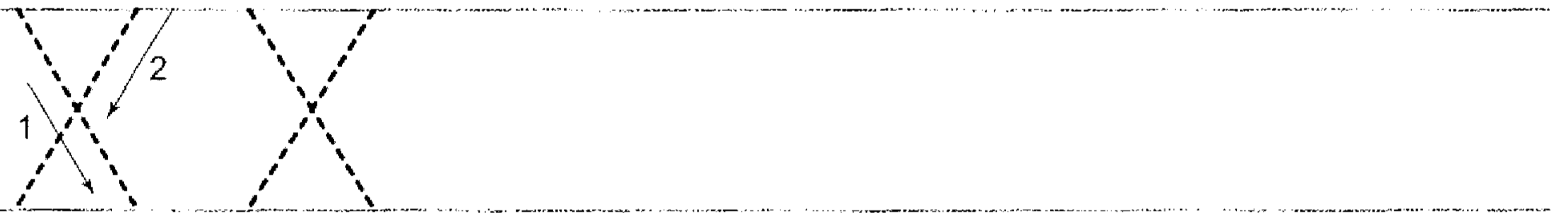

Выполни штриховку этих предметов прямыми линиями, оставляя окошечки незаштрихованными. Раскрась картинки.

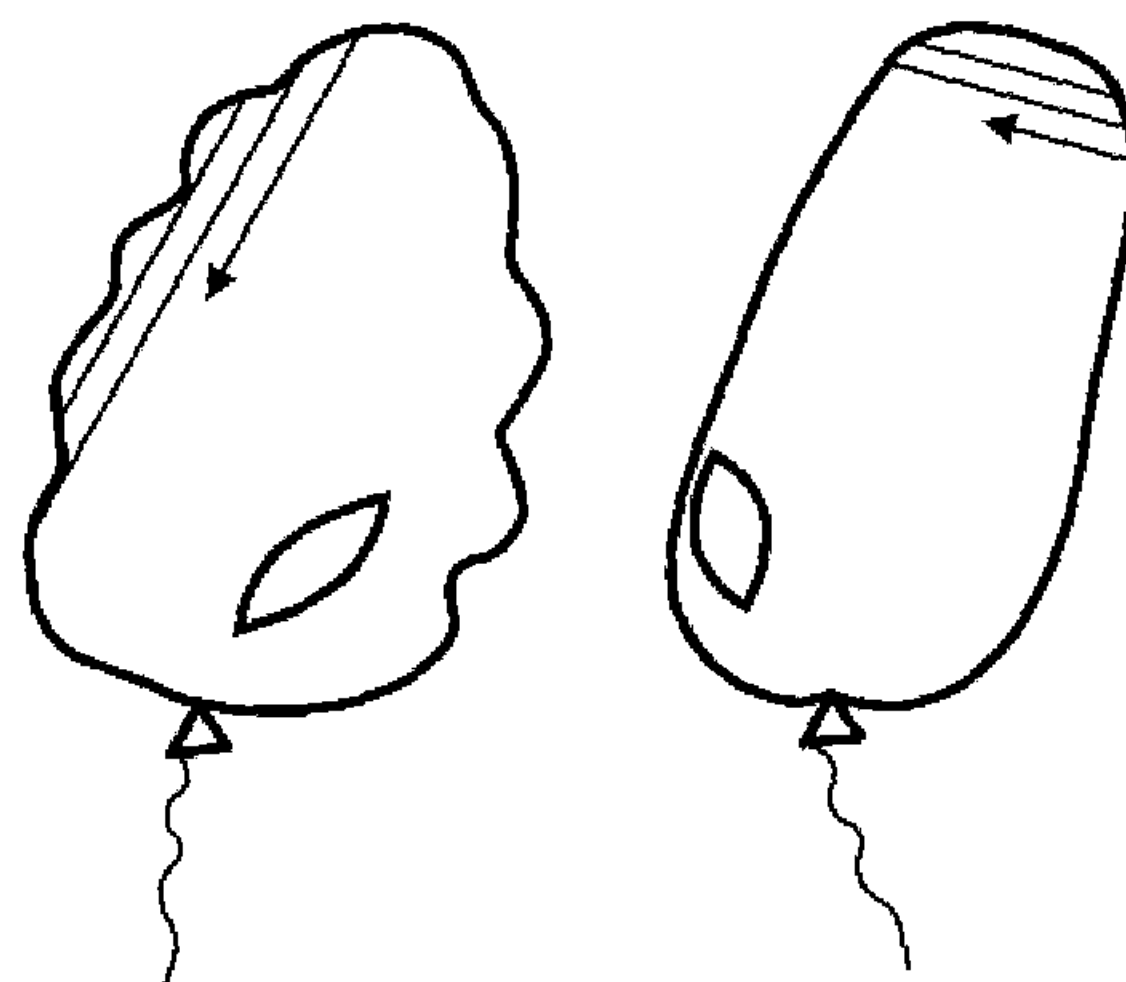
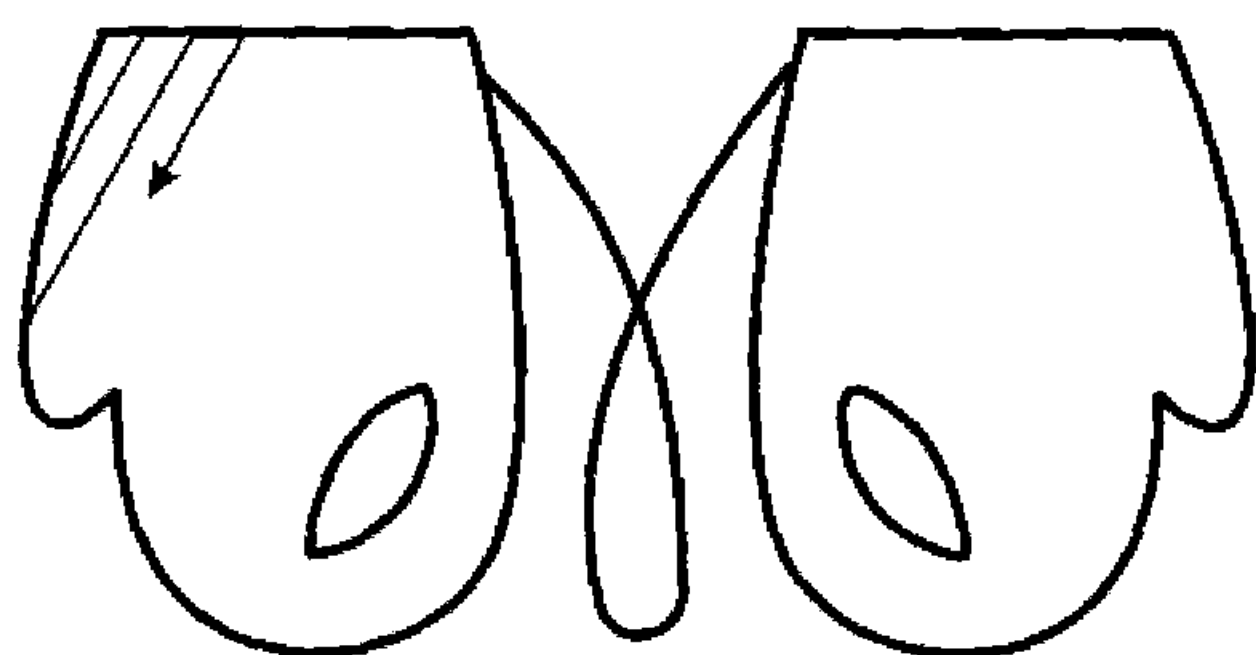
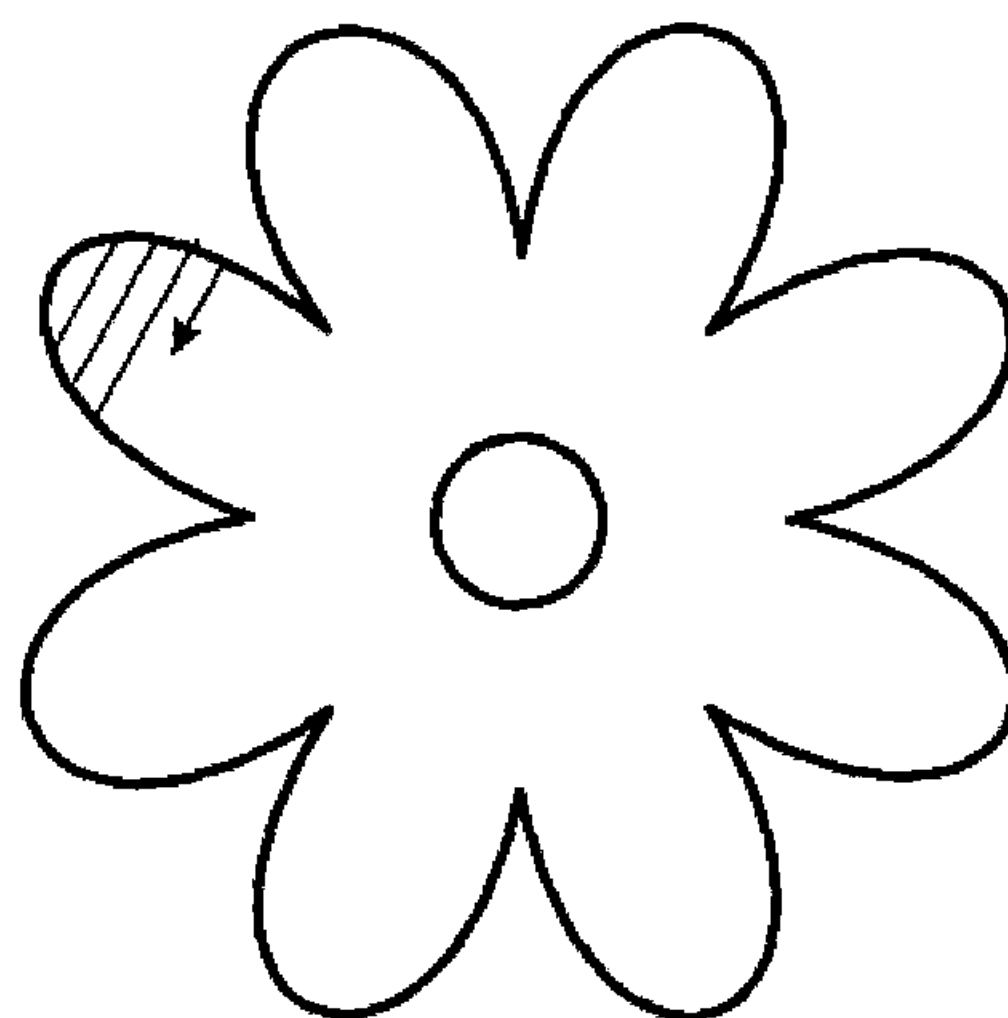
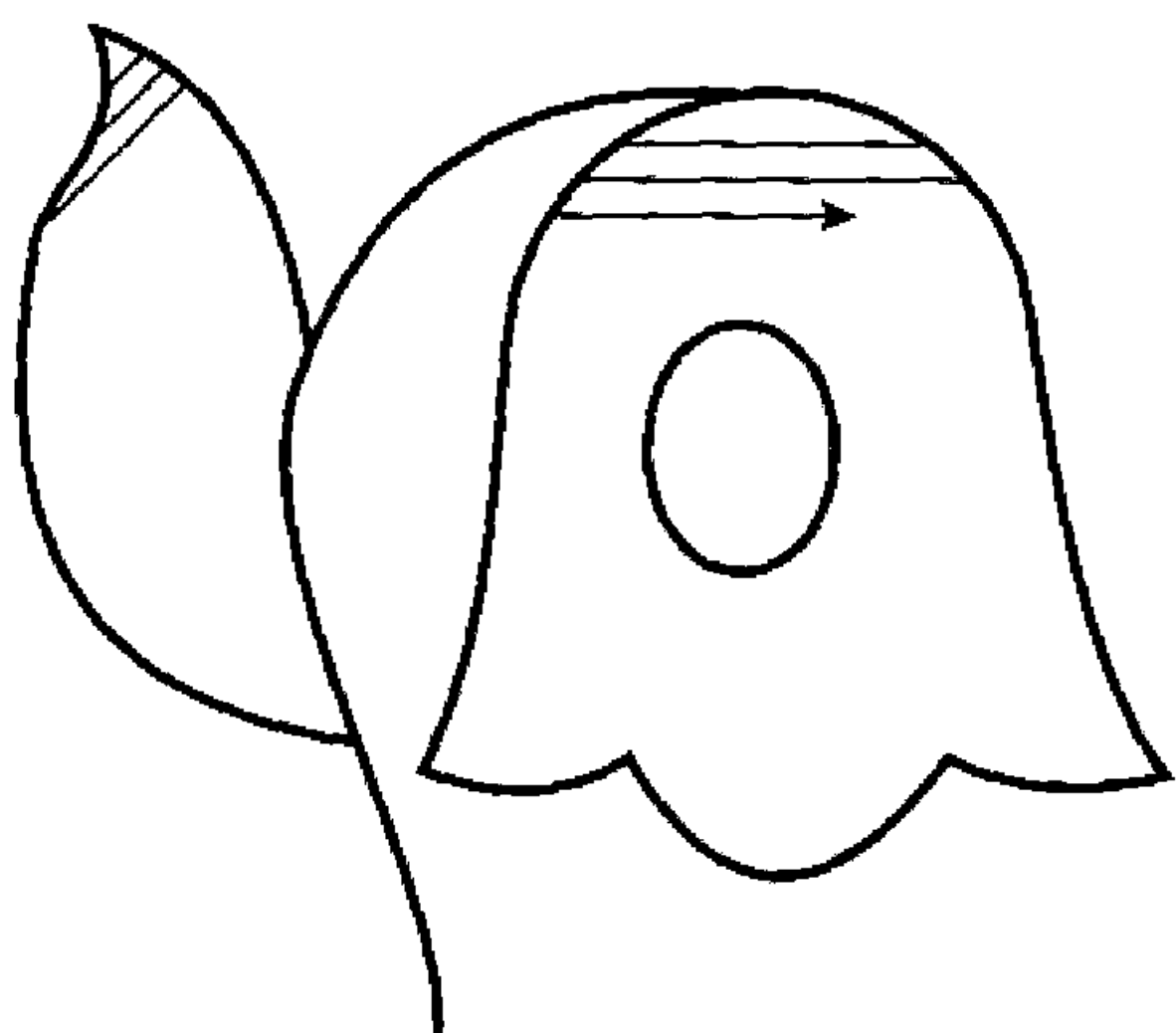
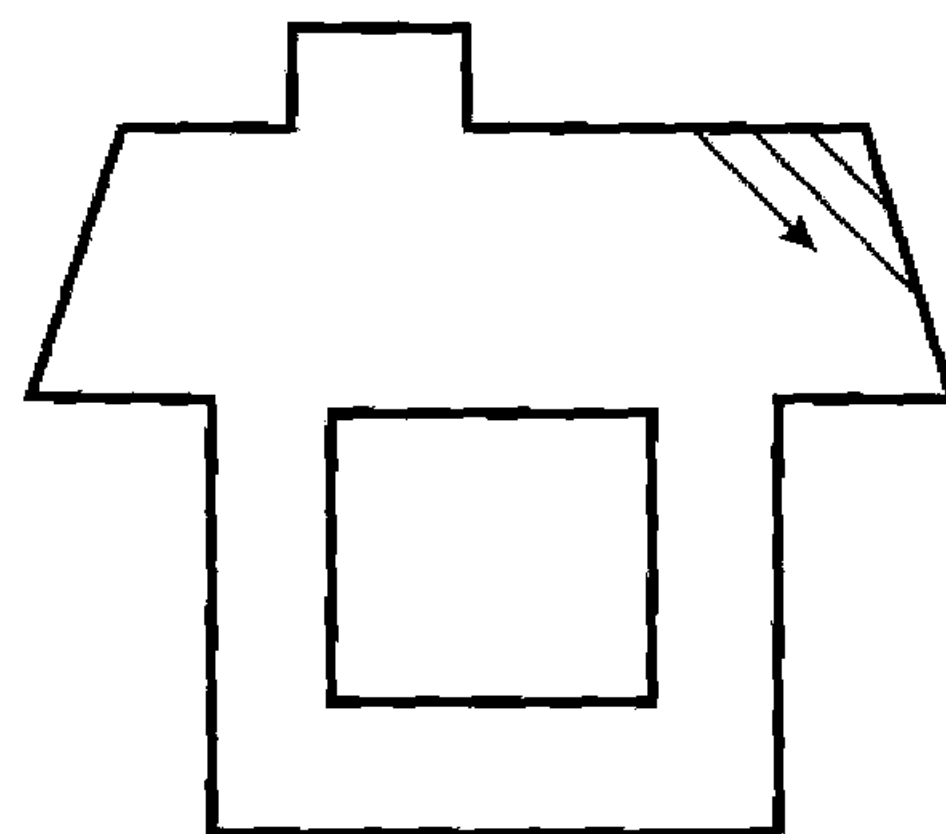
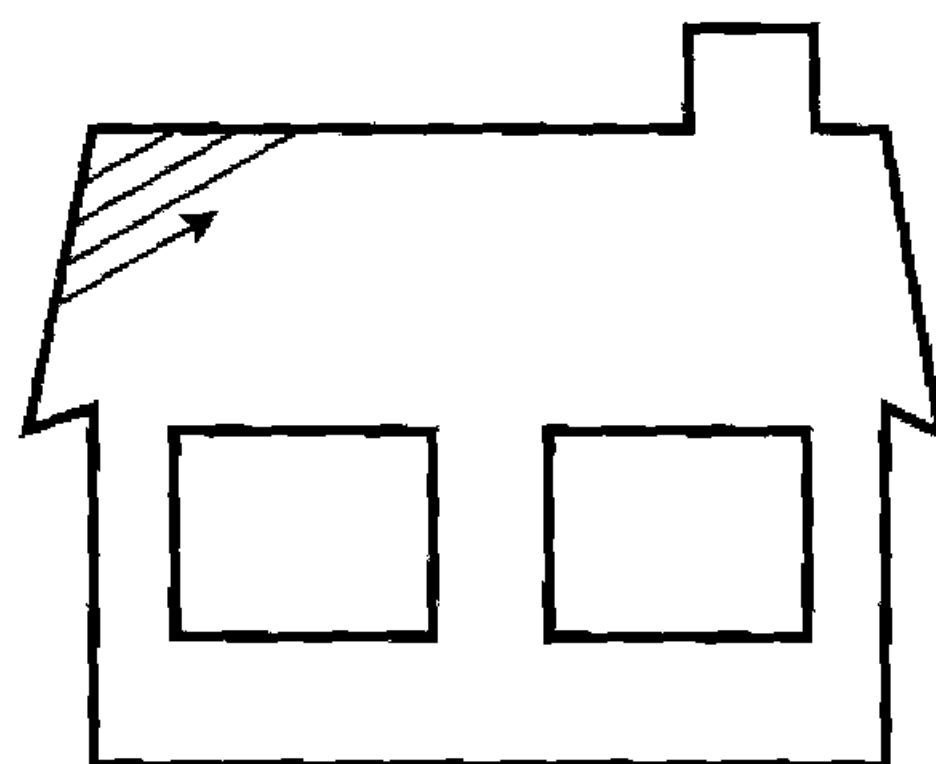
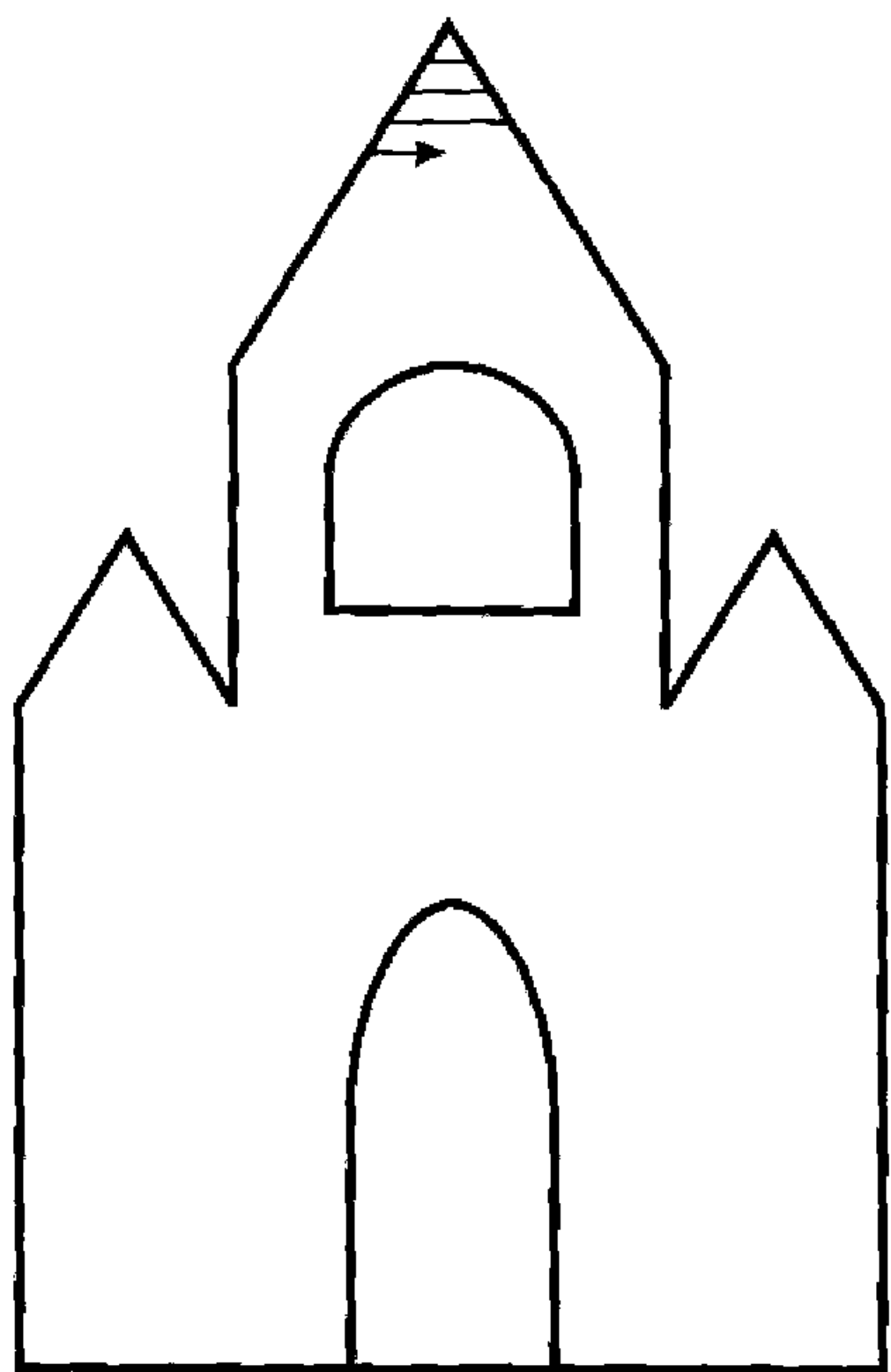



Щ

Щапля

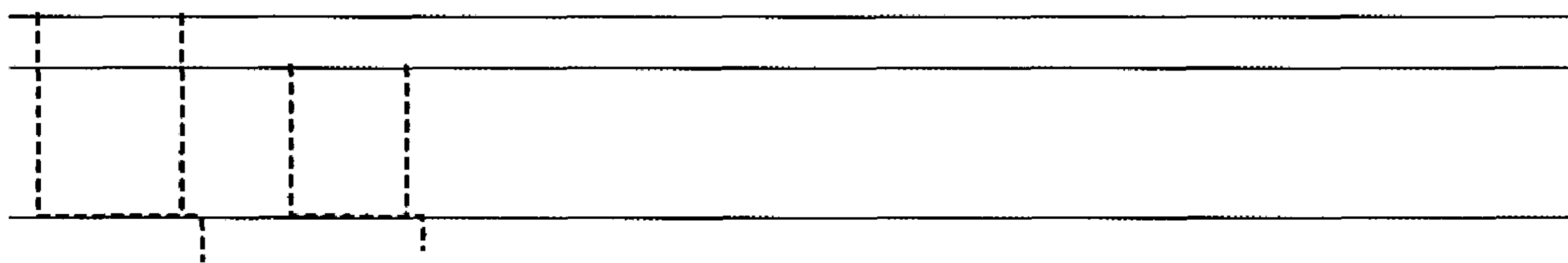
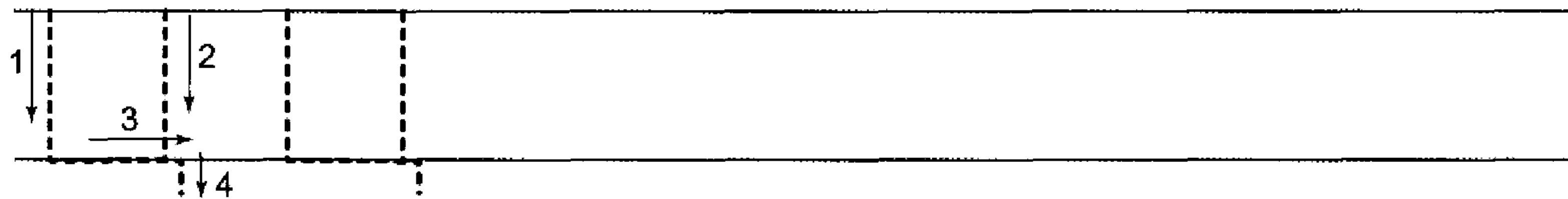
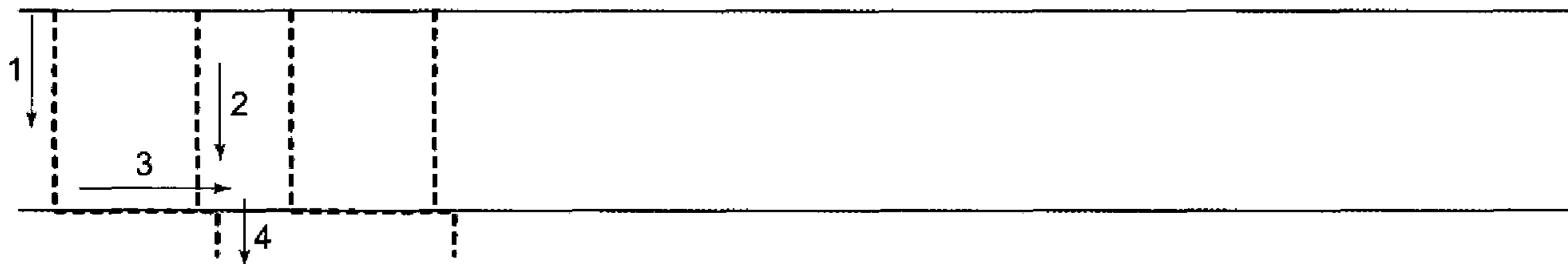
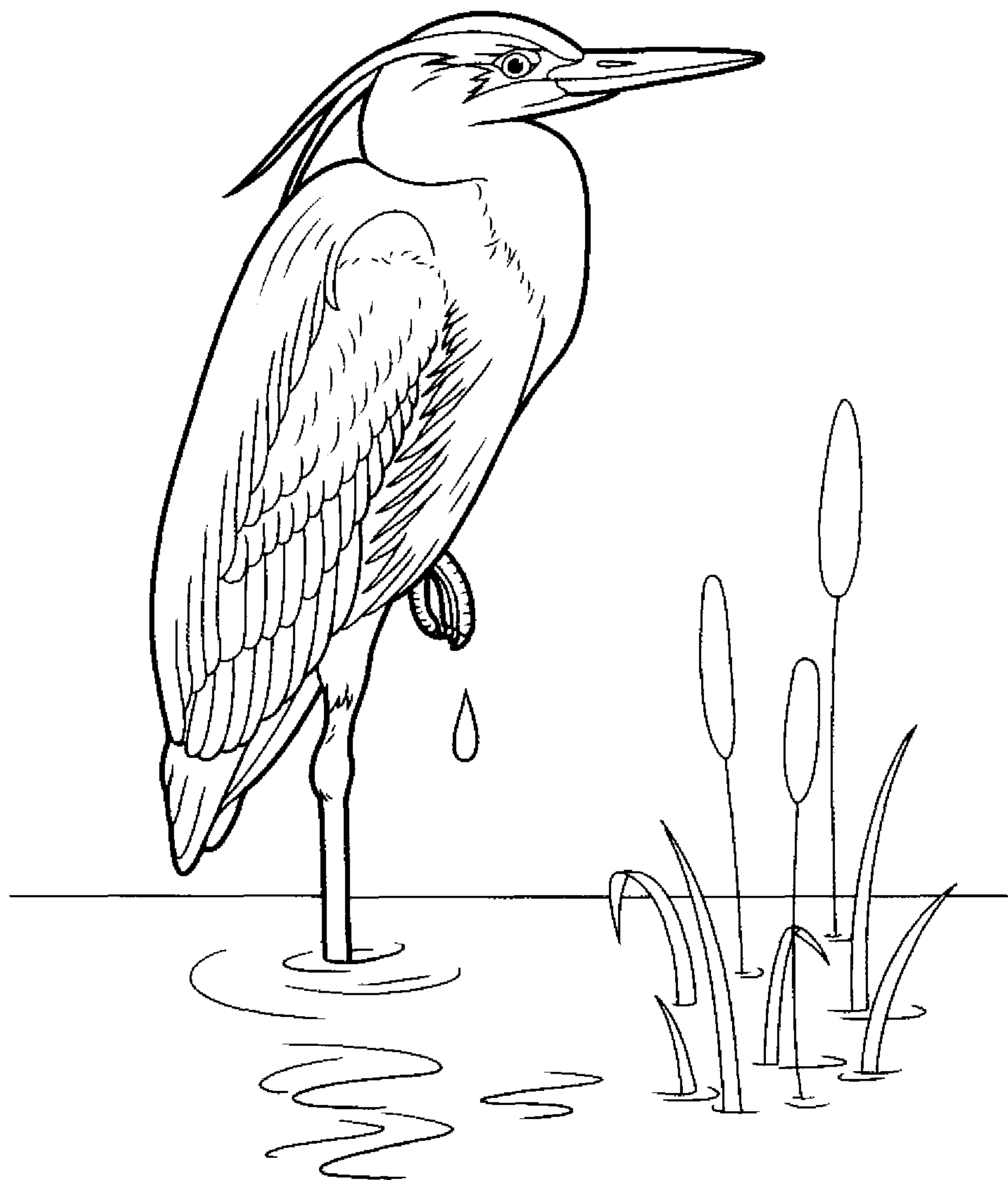

Нарисуй справа в пустых клеточках точно такие же фигуры и раскрась их.

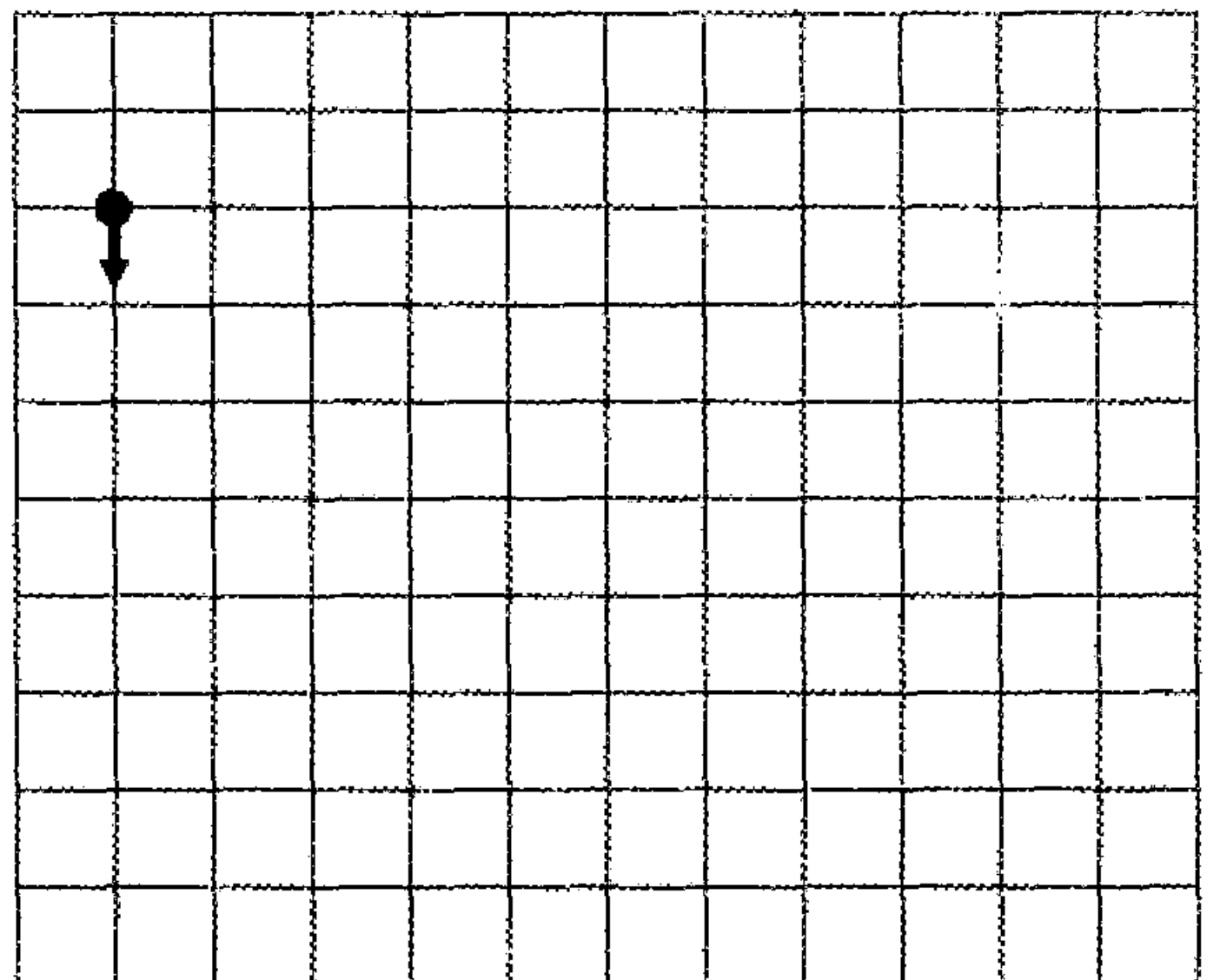
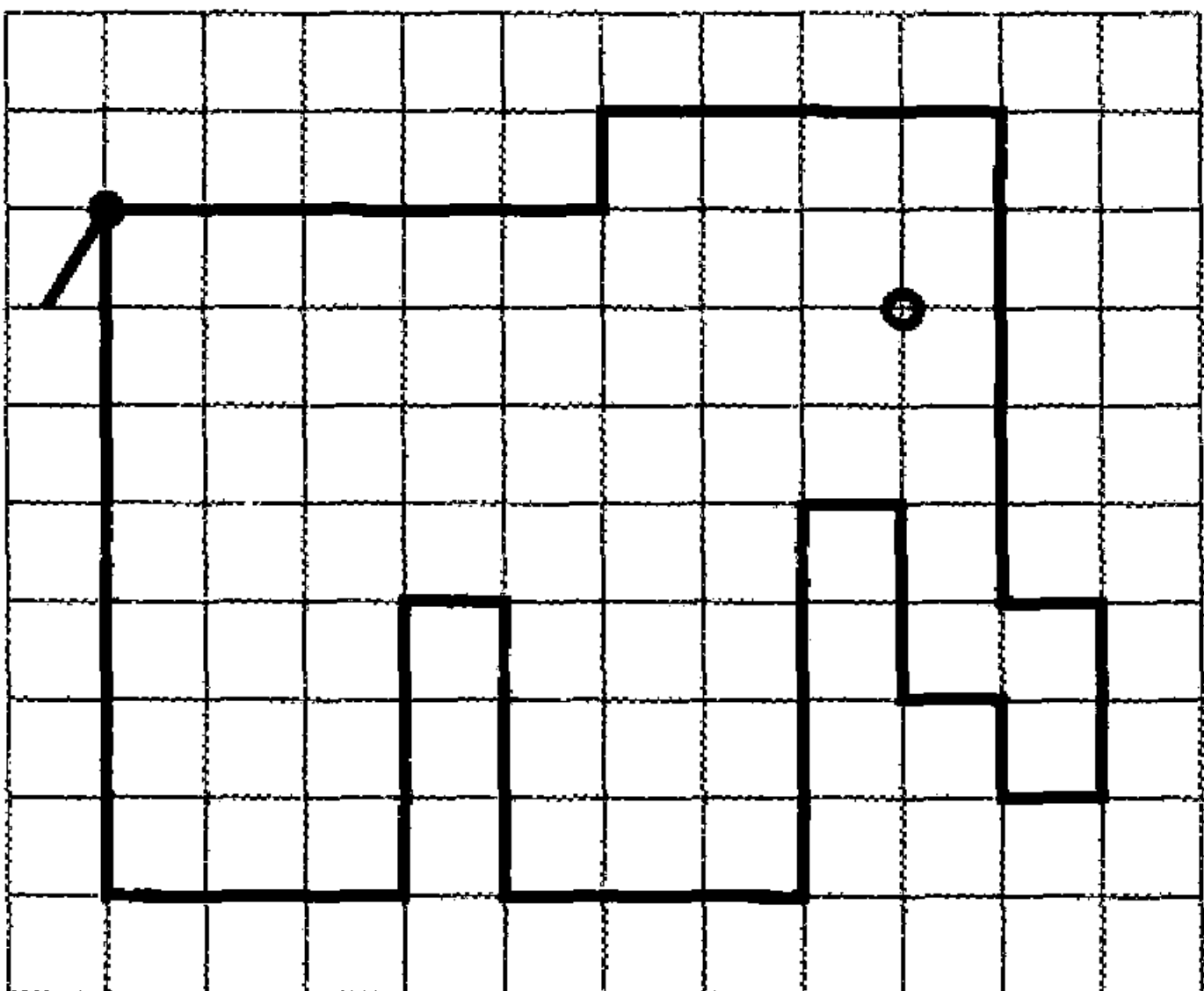
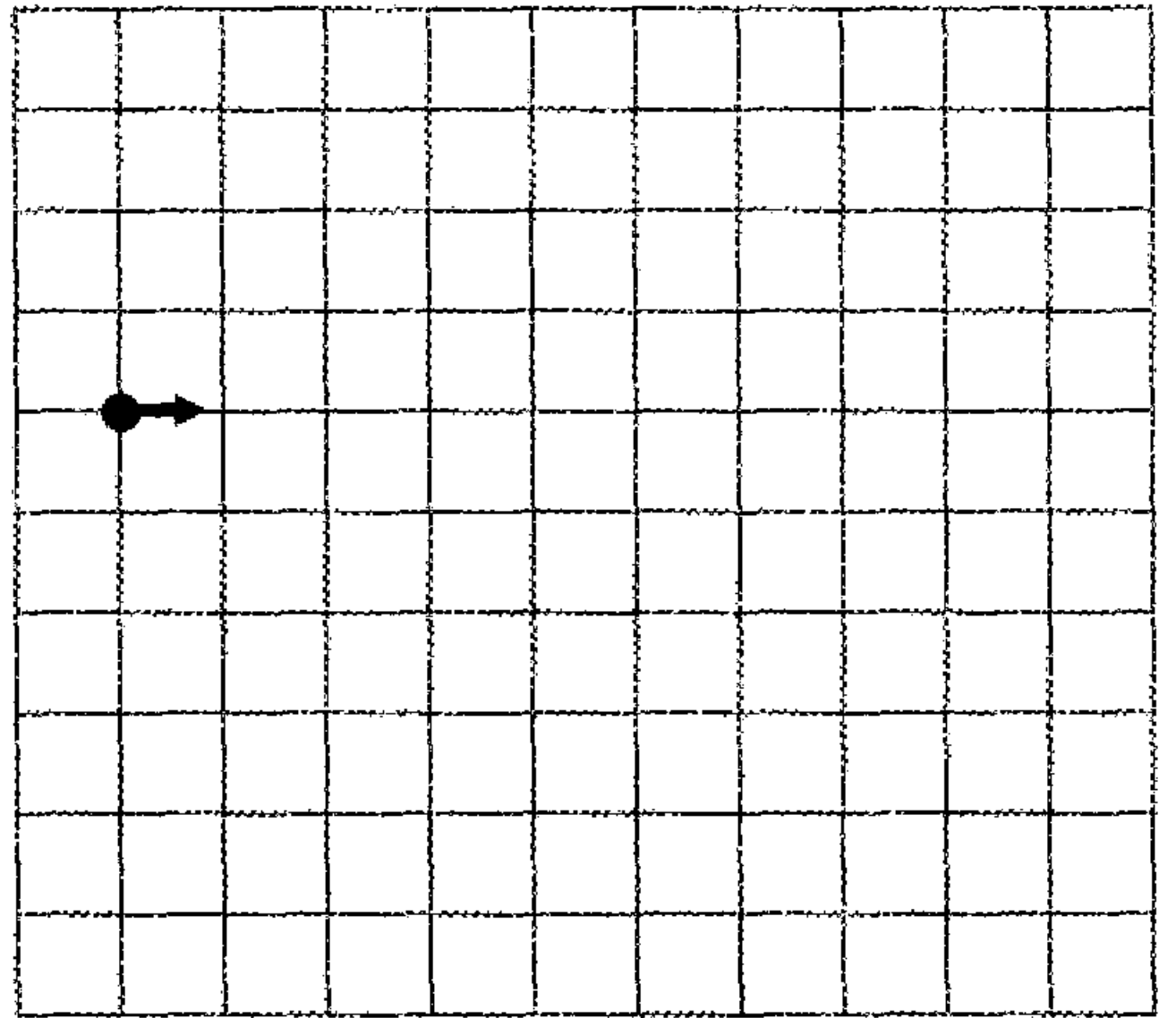
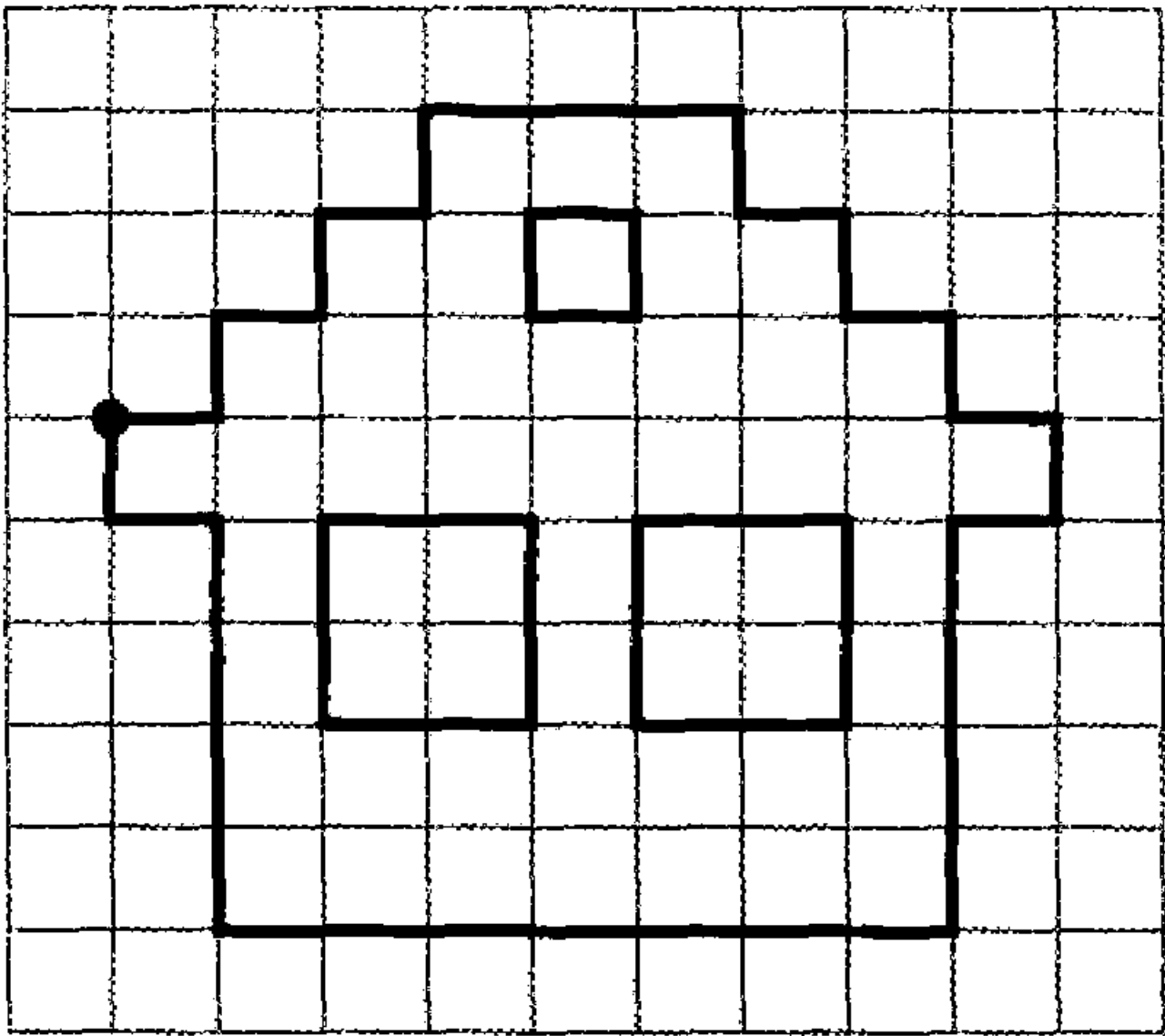
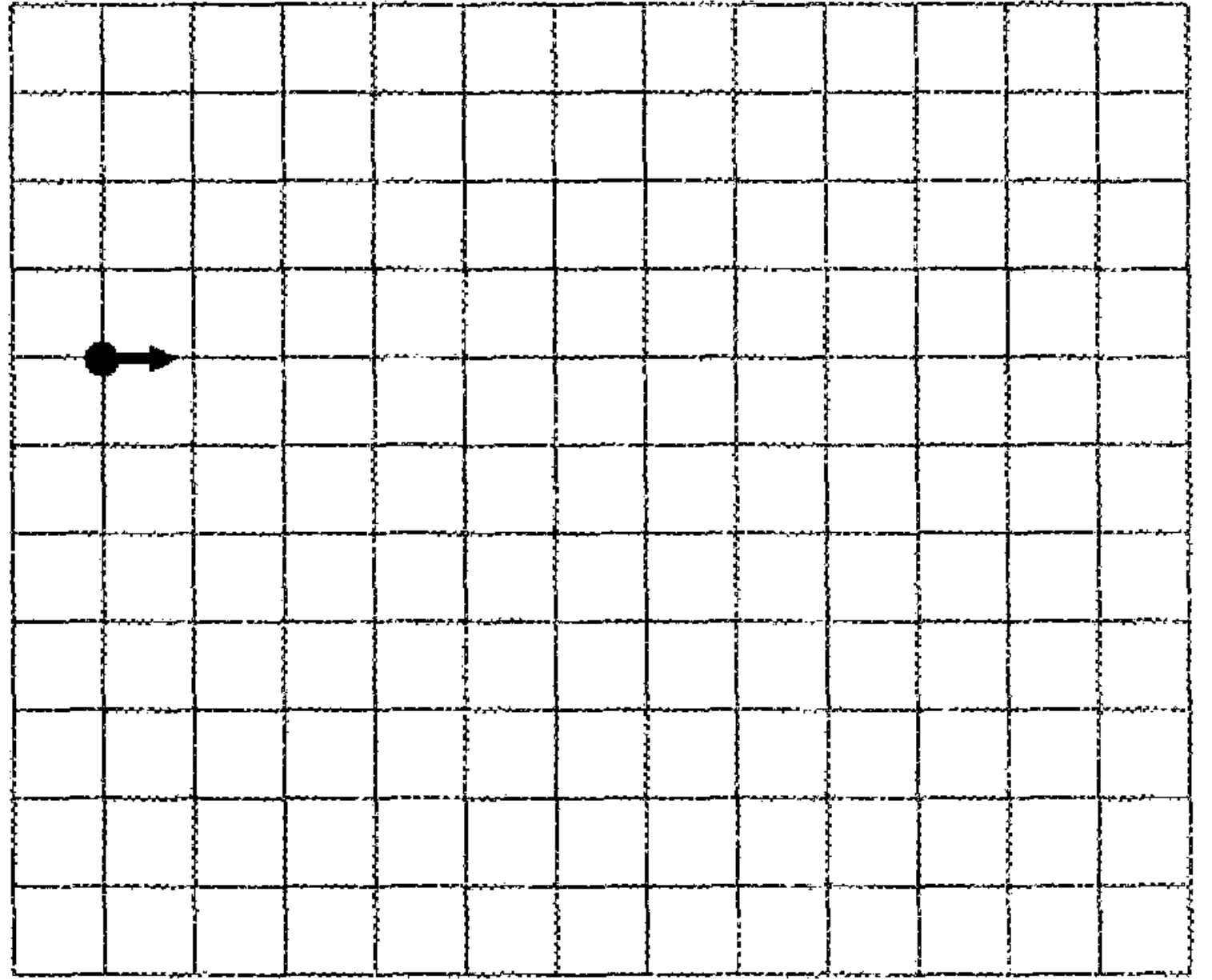
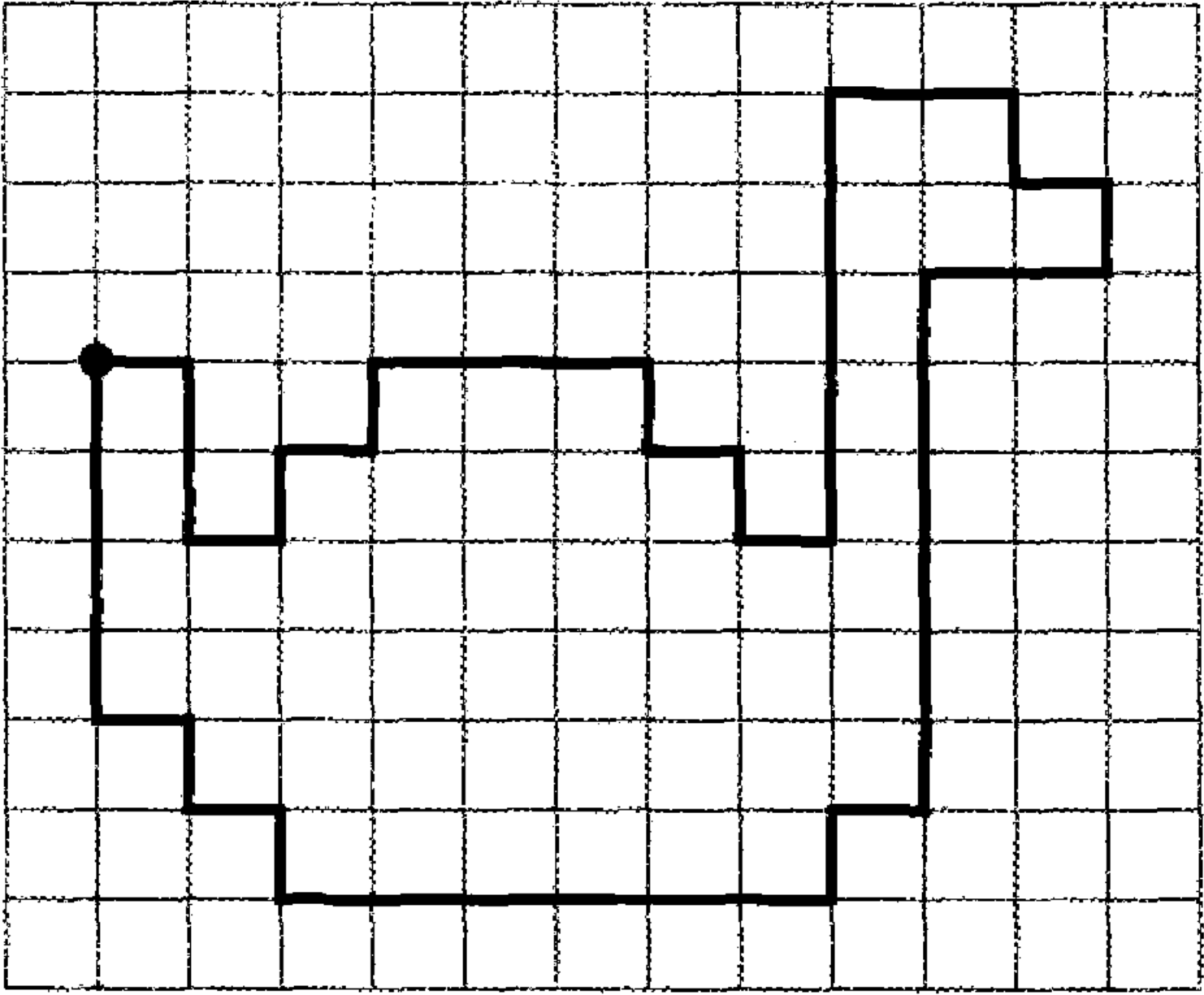

# 4

Черепаха

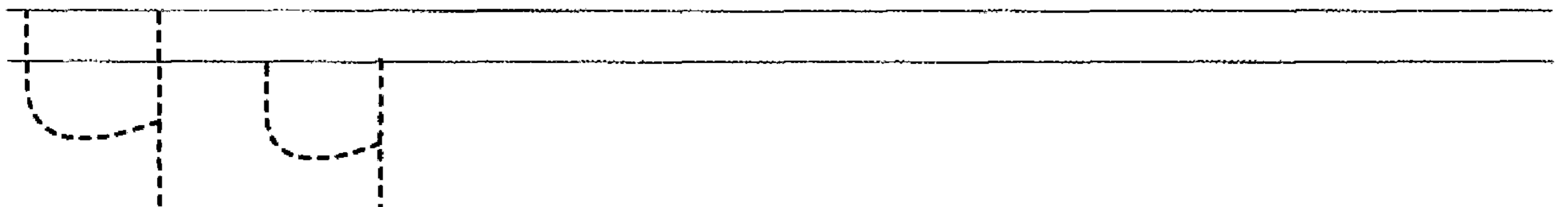
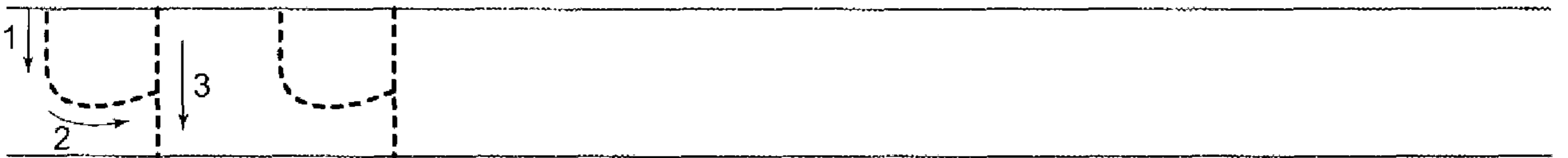
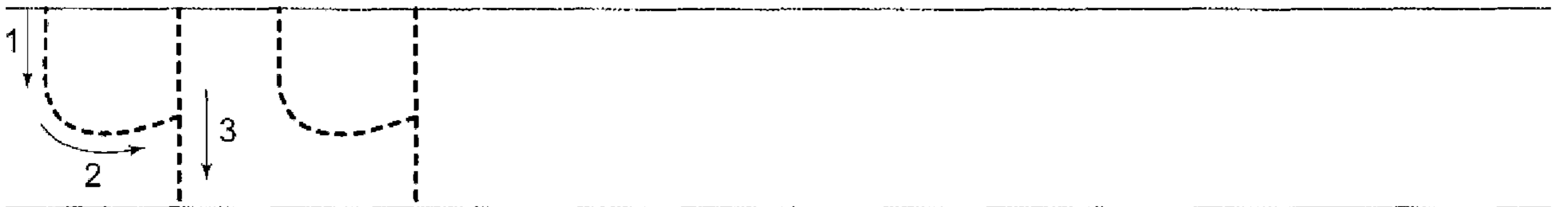
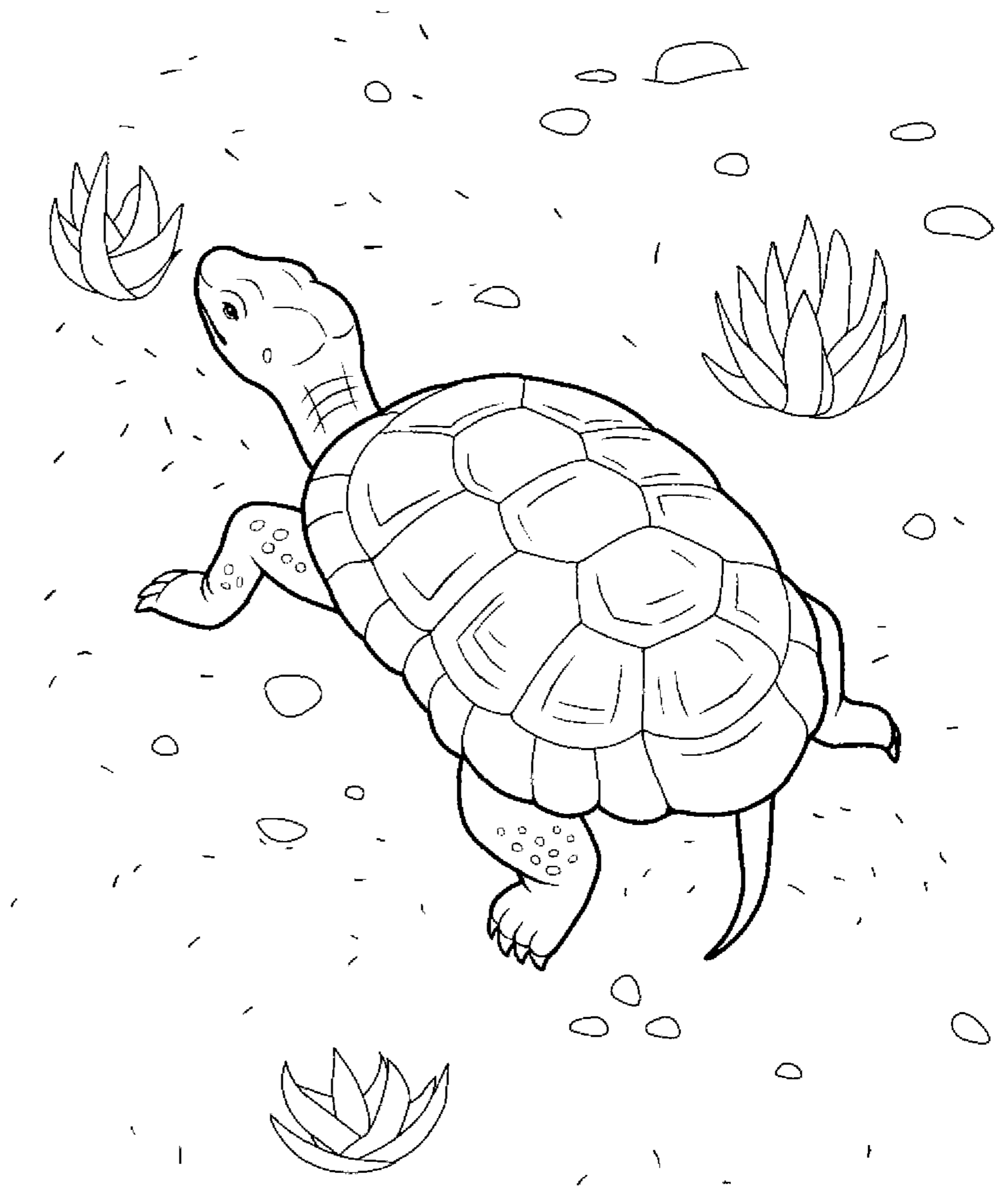

Обведи рисунки точно по линиям, не отрывая карандаш от бумаги. Раскрась картинки.

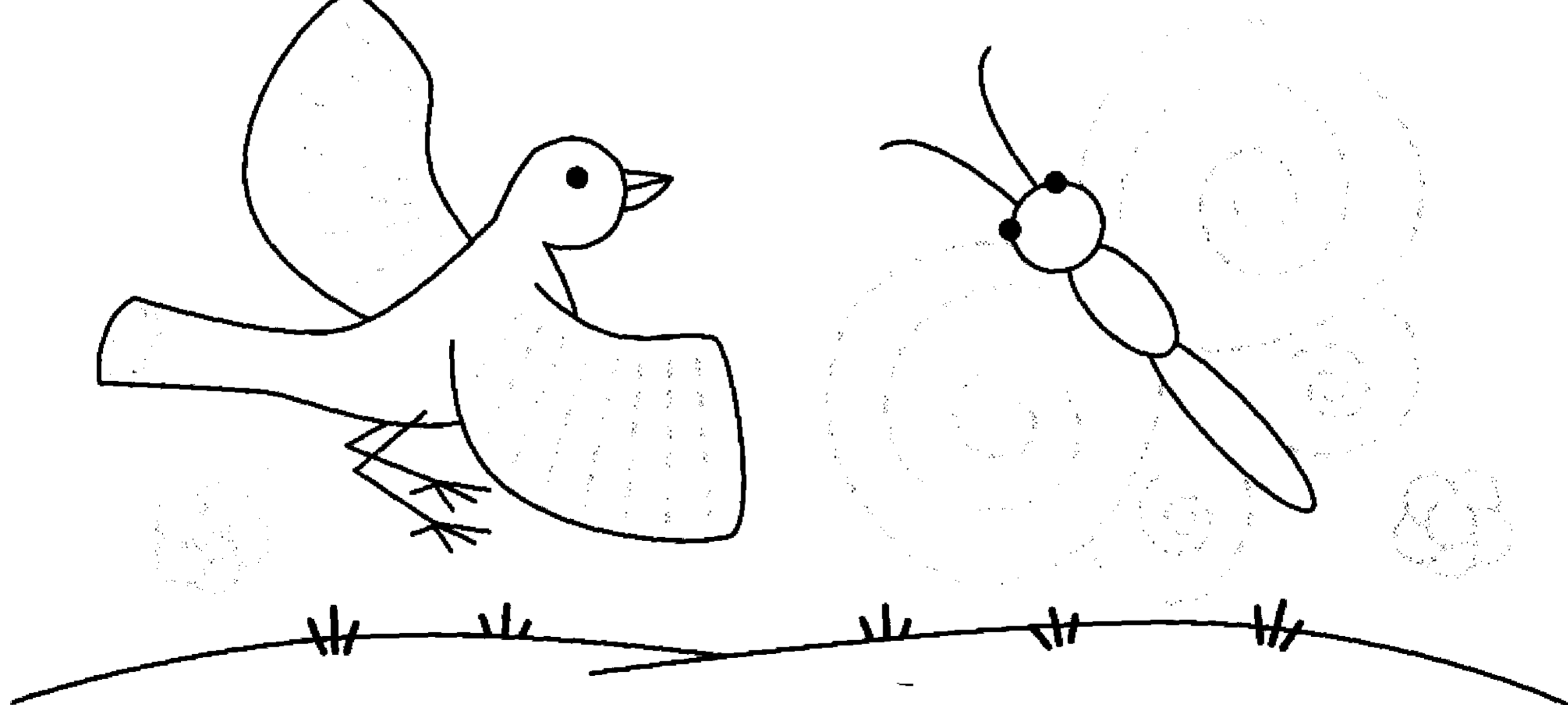
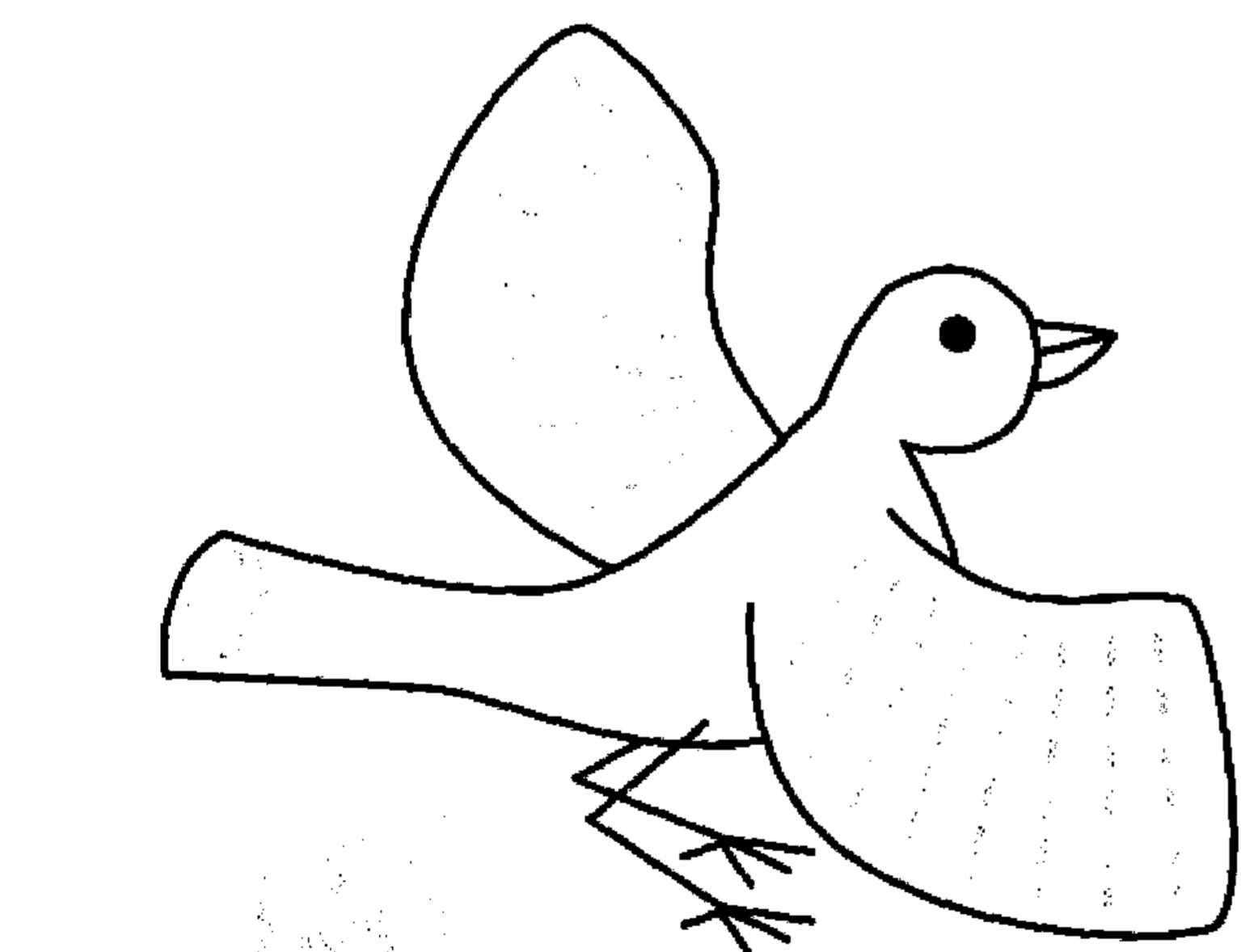
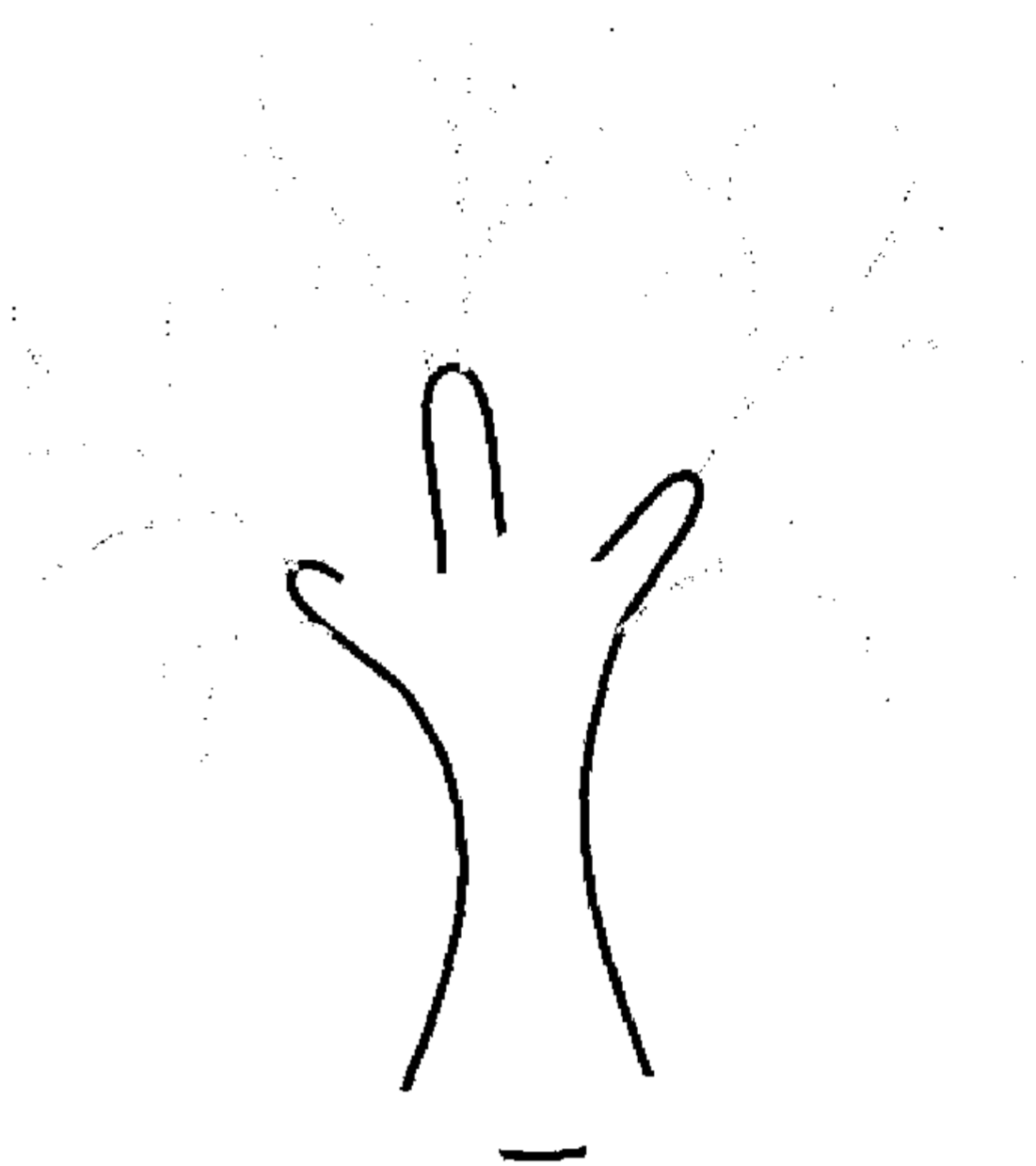
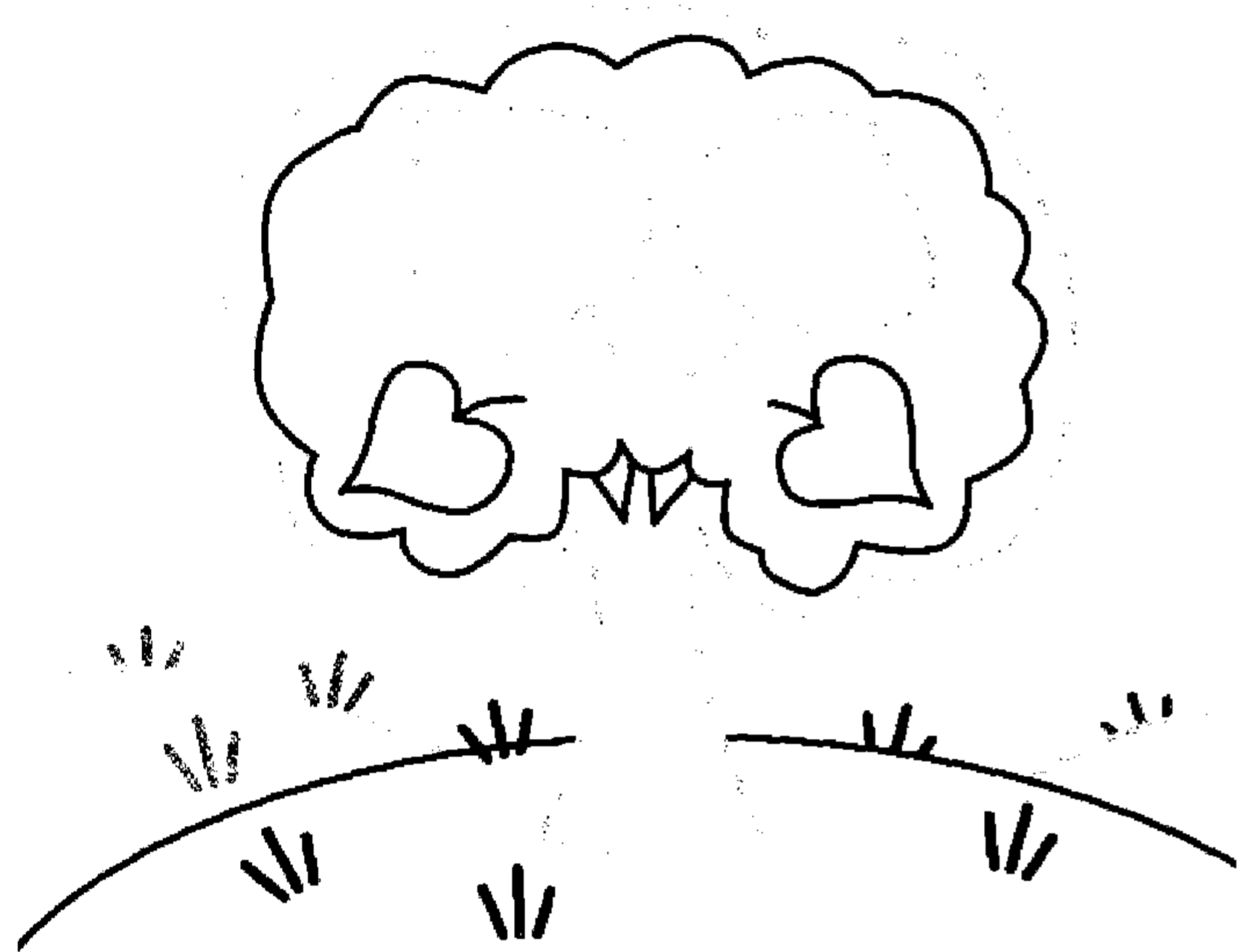

Ш Ш Ш

Шмель

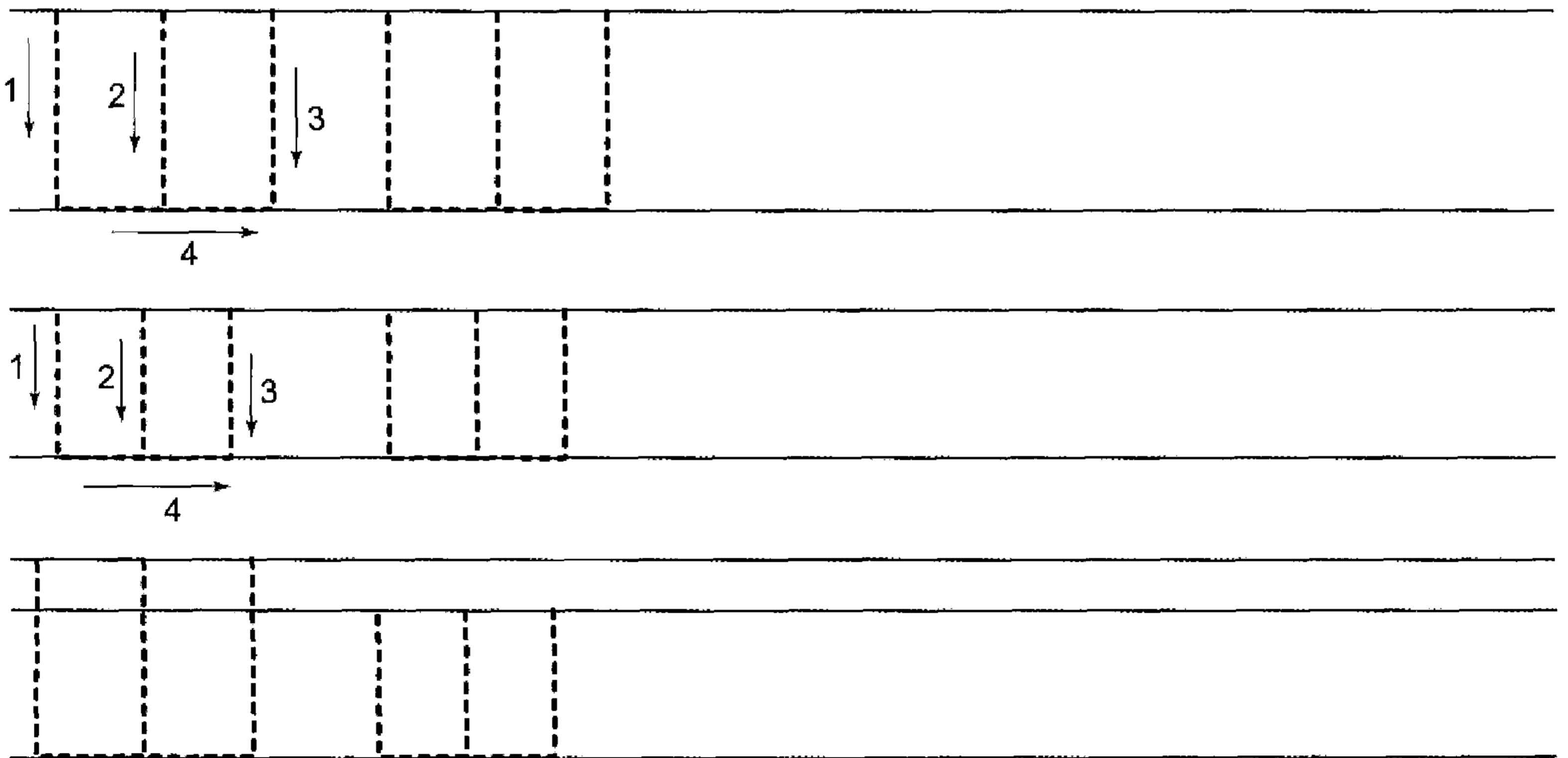
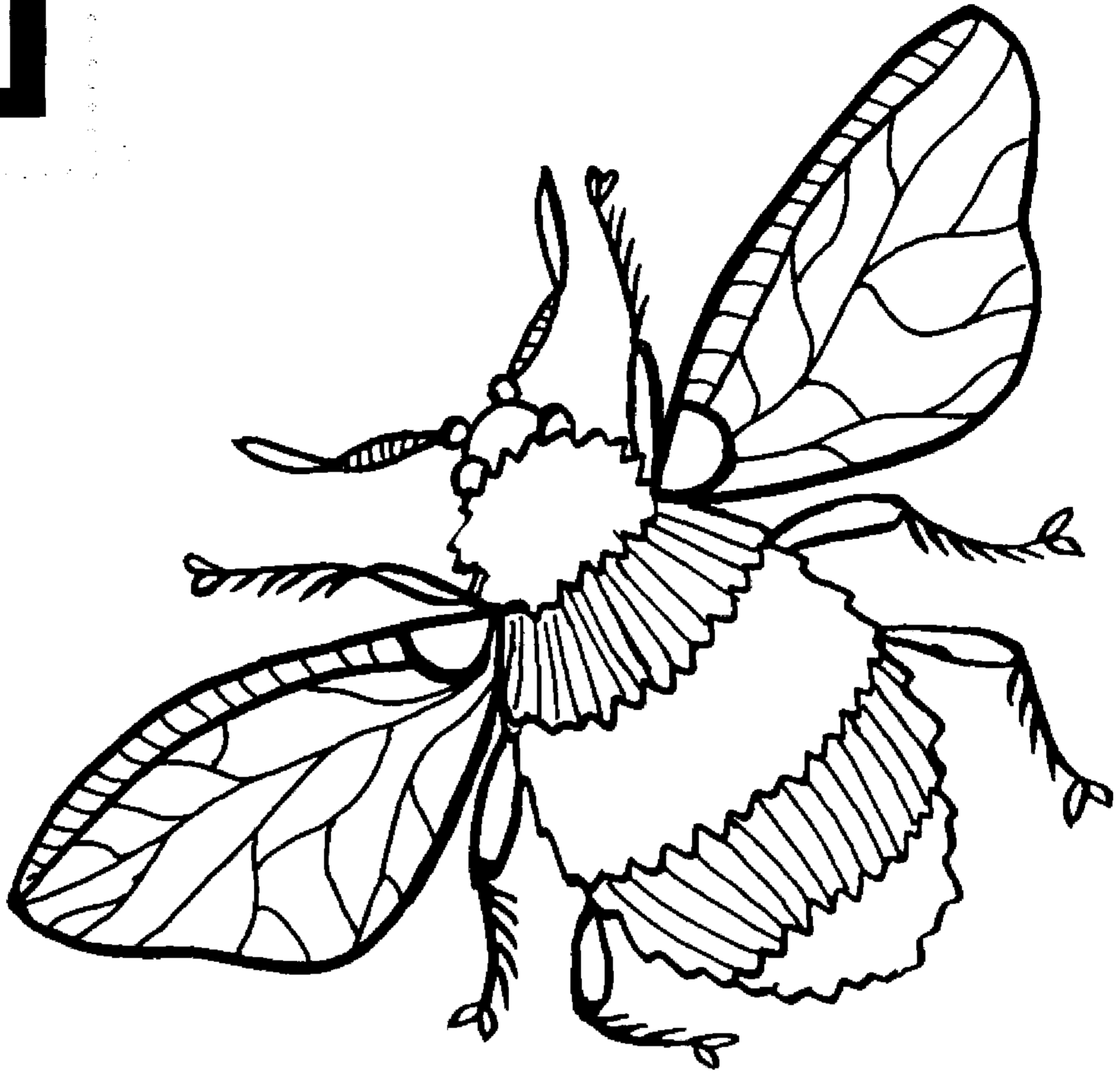

Дорисуй картинку. Соедини линии по точкам и раскрась.

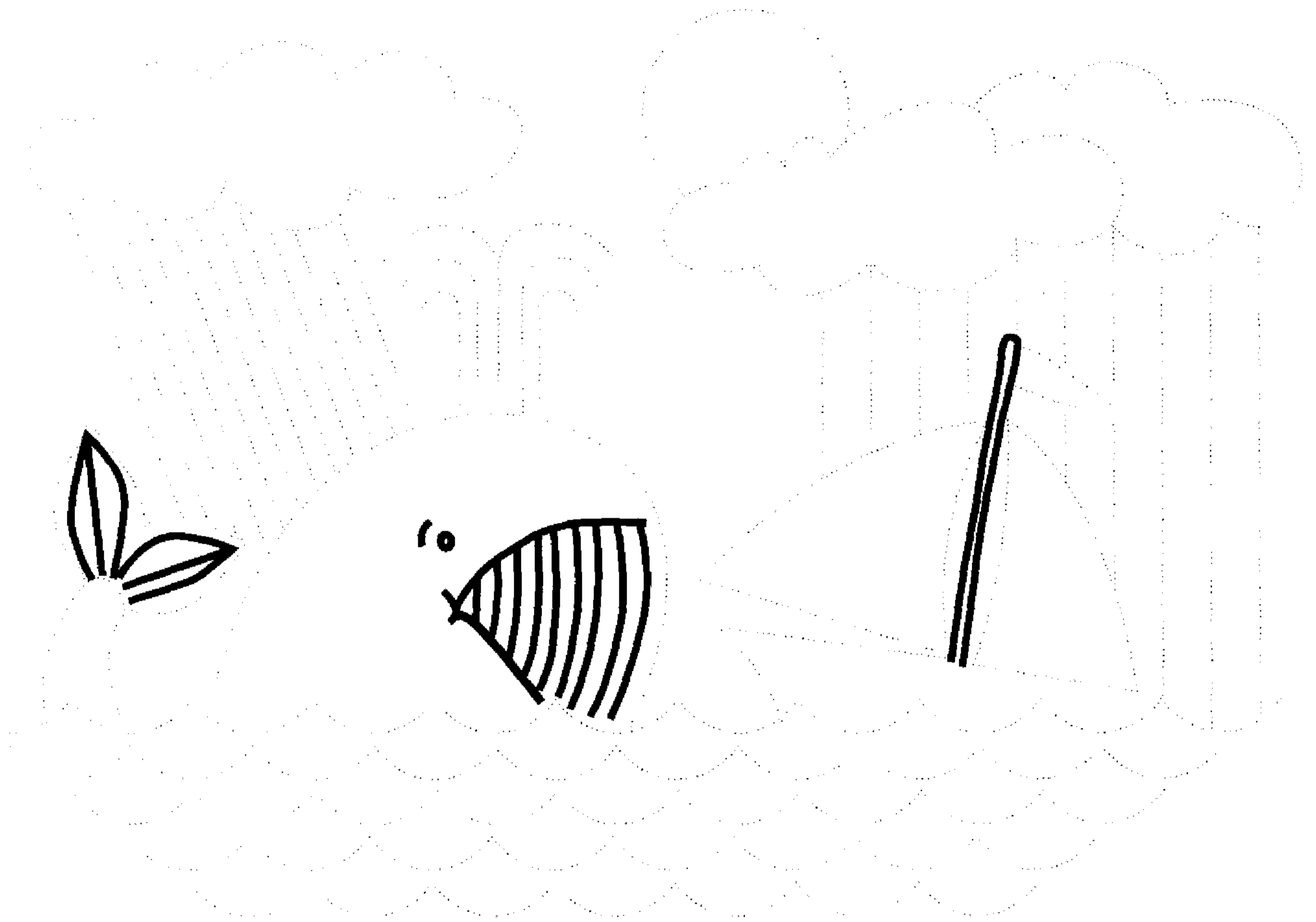

Выполни штриховку прямыми линиями, не выходя за контур рисунка, и раскрась.

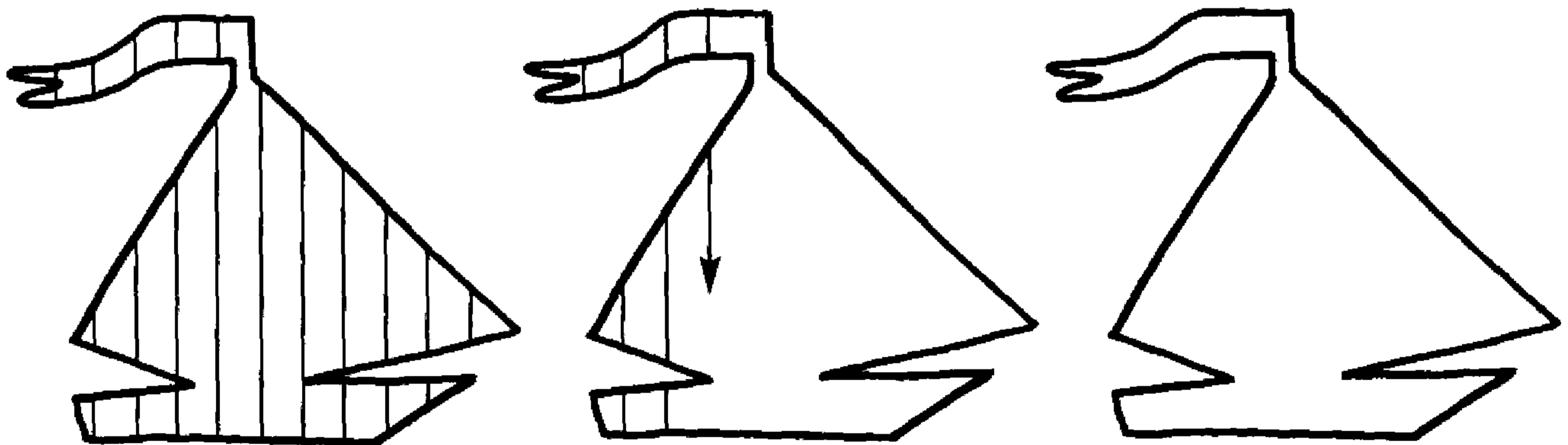

ЩЩЩ

Щенок

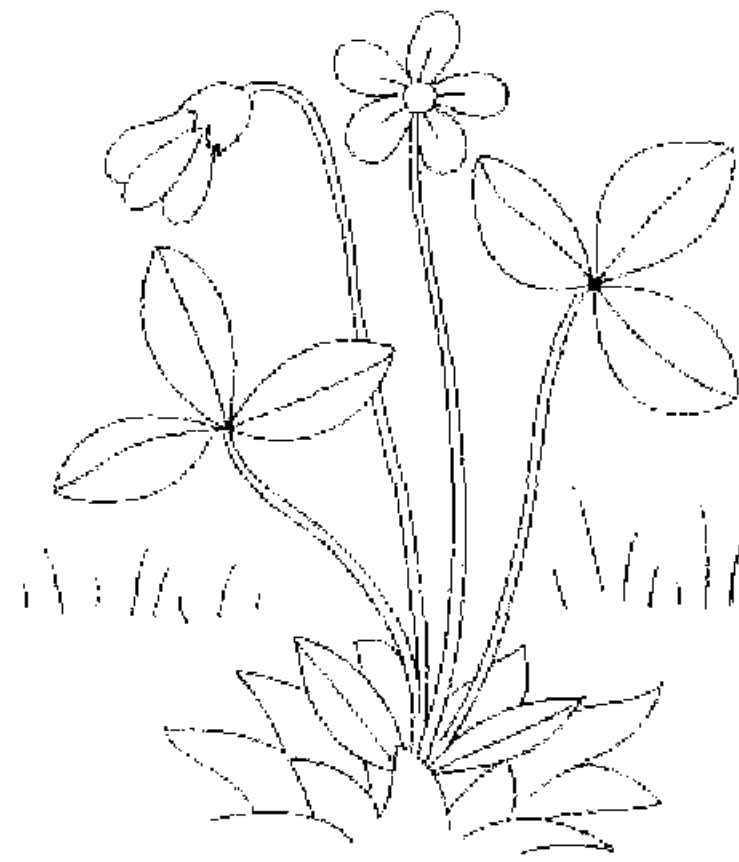

Tracing practice lines for the Cyrillic letter 'Щ'. The first two rows show the stroke order: 1 (vertical down), 2 (vertical down), 3 (vertical down), 4 (horizontal right), and 5 (vertical down). The third row is a blank template for practice.

Нарисуй узоры на рукавичках, шарфике и шапочке. Раскрась картин-  
тинки.





Ъ

Нет такого животного, в названии  
которого была бы буква «Ъ».  
Нарисуй любое животное  
и раскрась его.

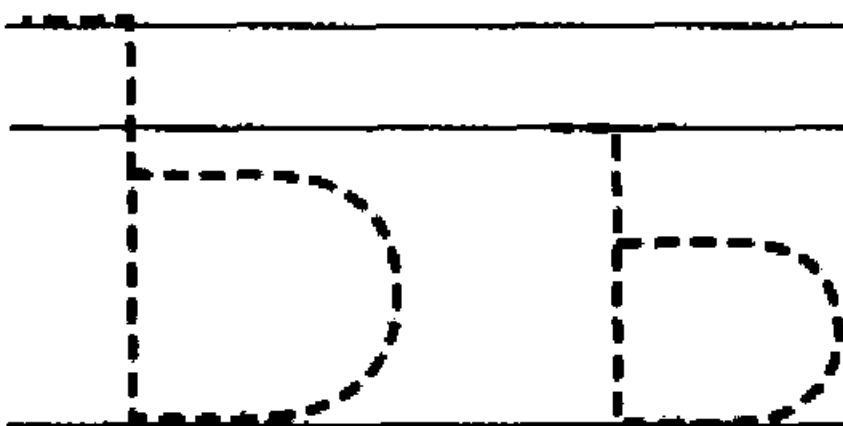
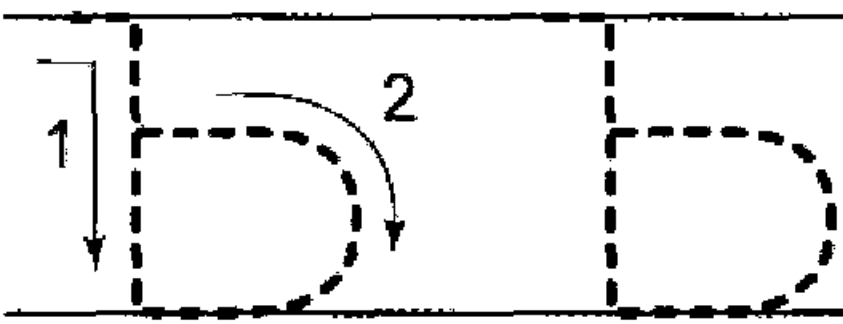
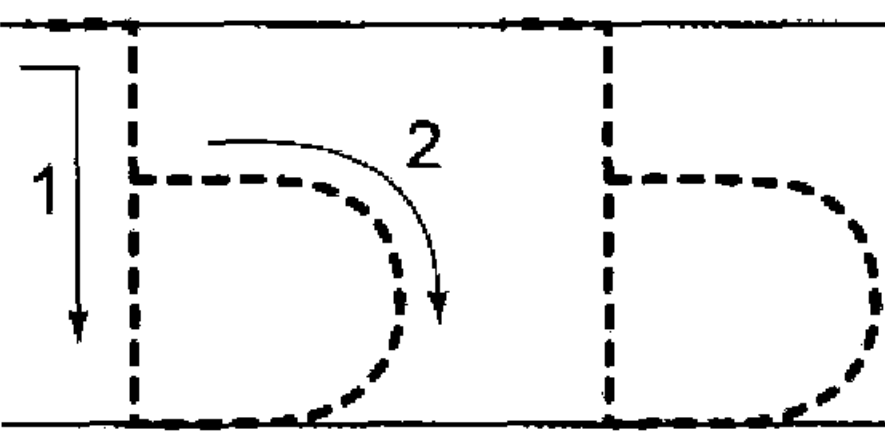

б

Олень

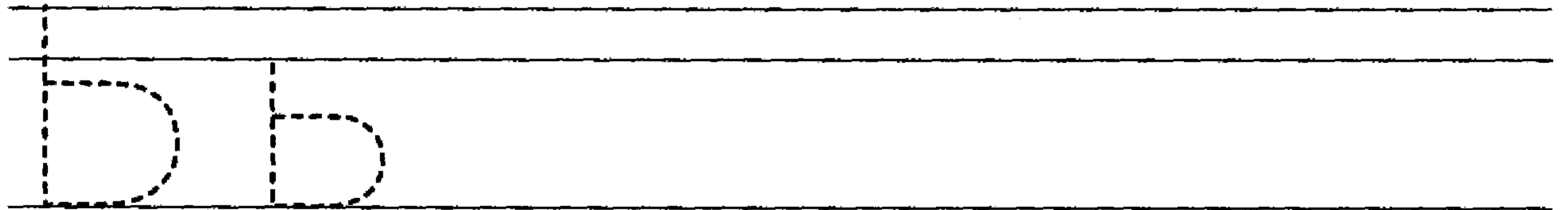
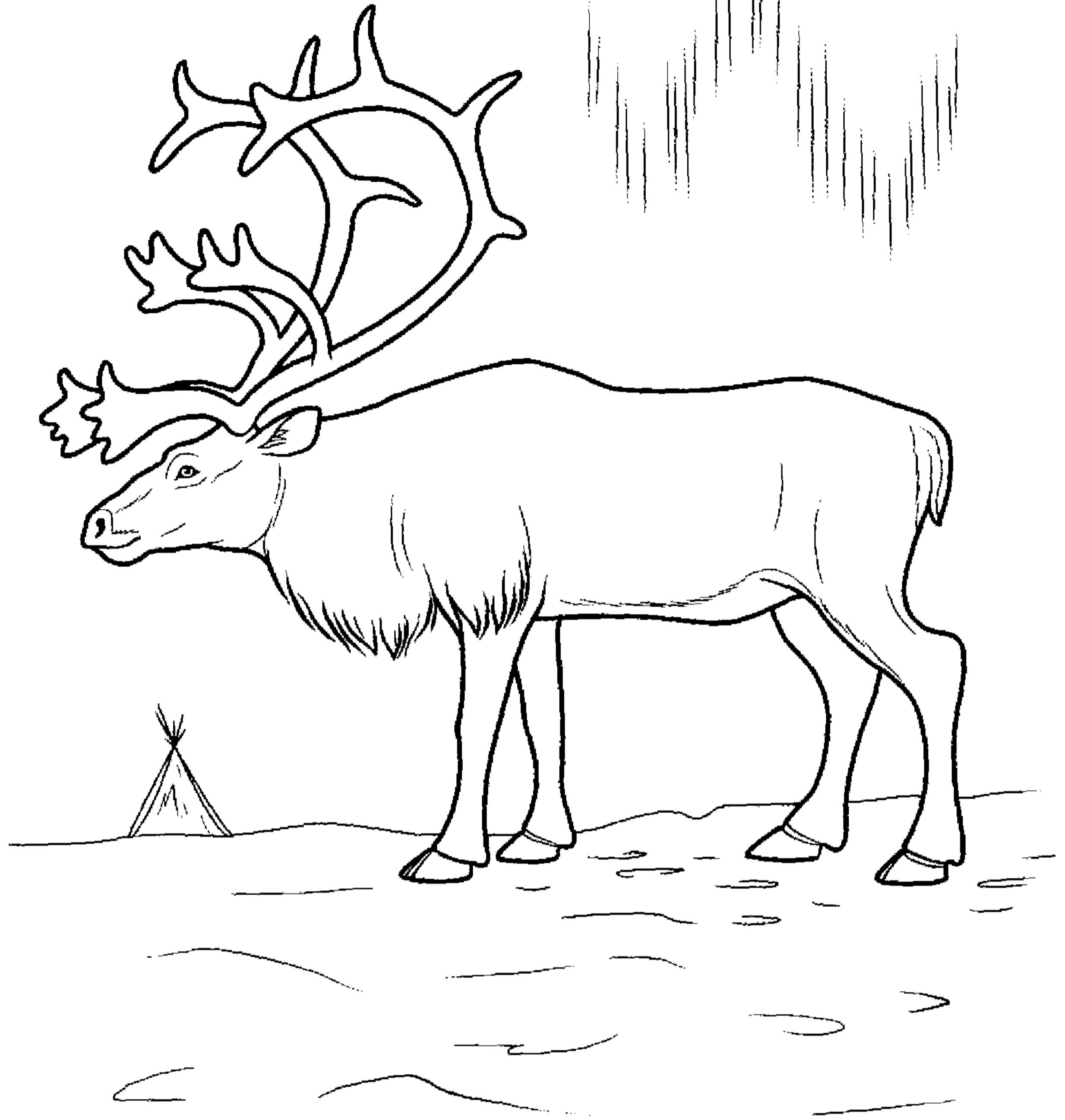

# Ы

Выдра

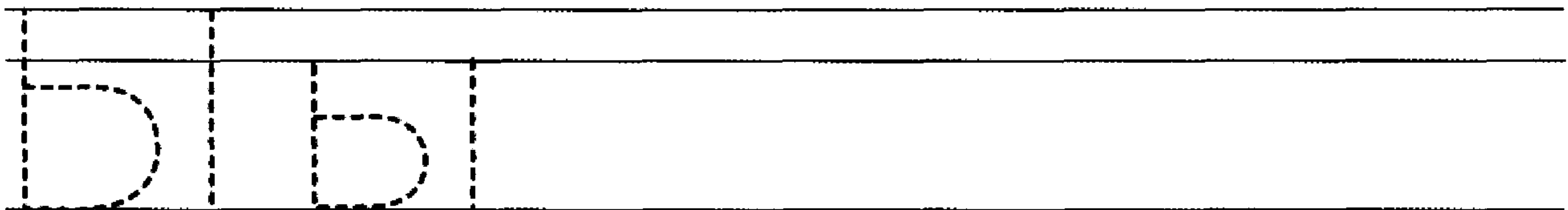
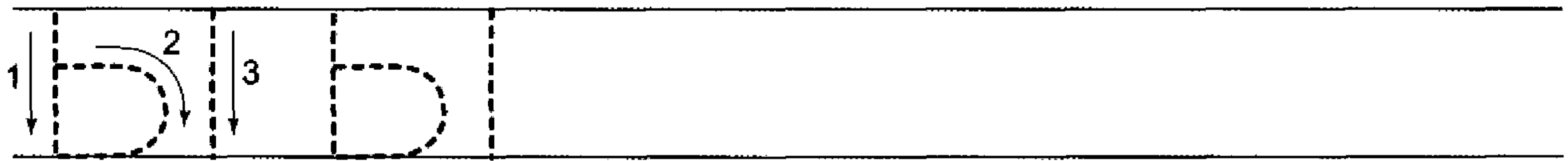
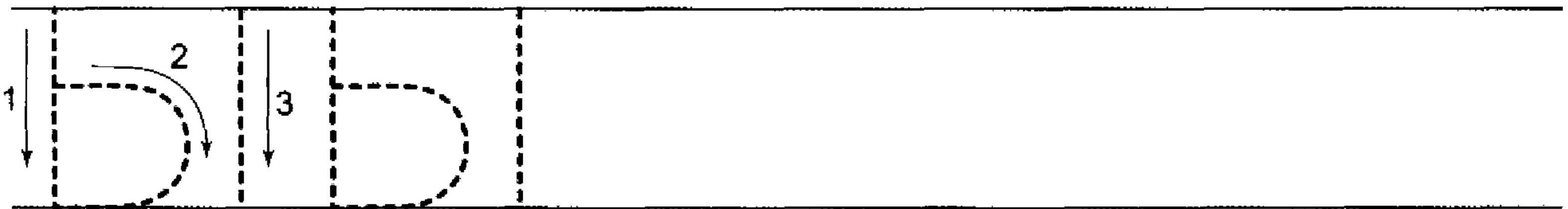

Обведи картинки по пунктирным линиям. Раскрась их.

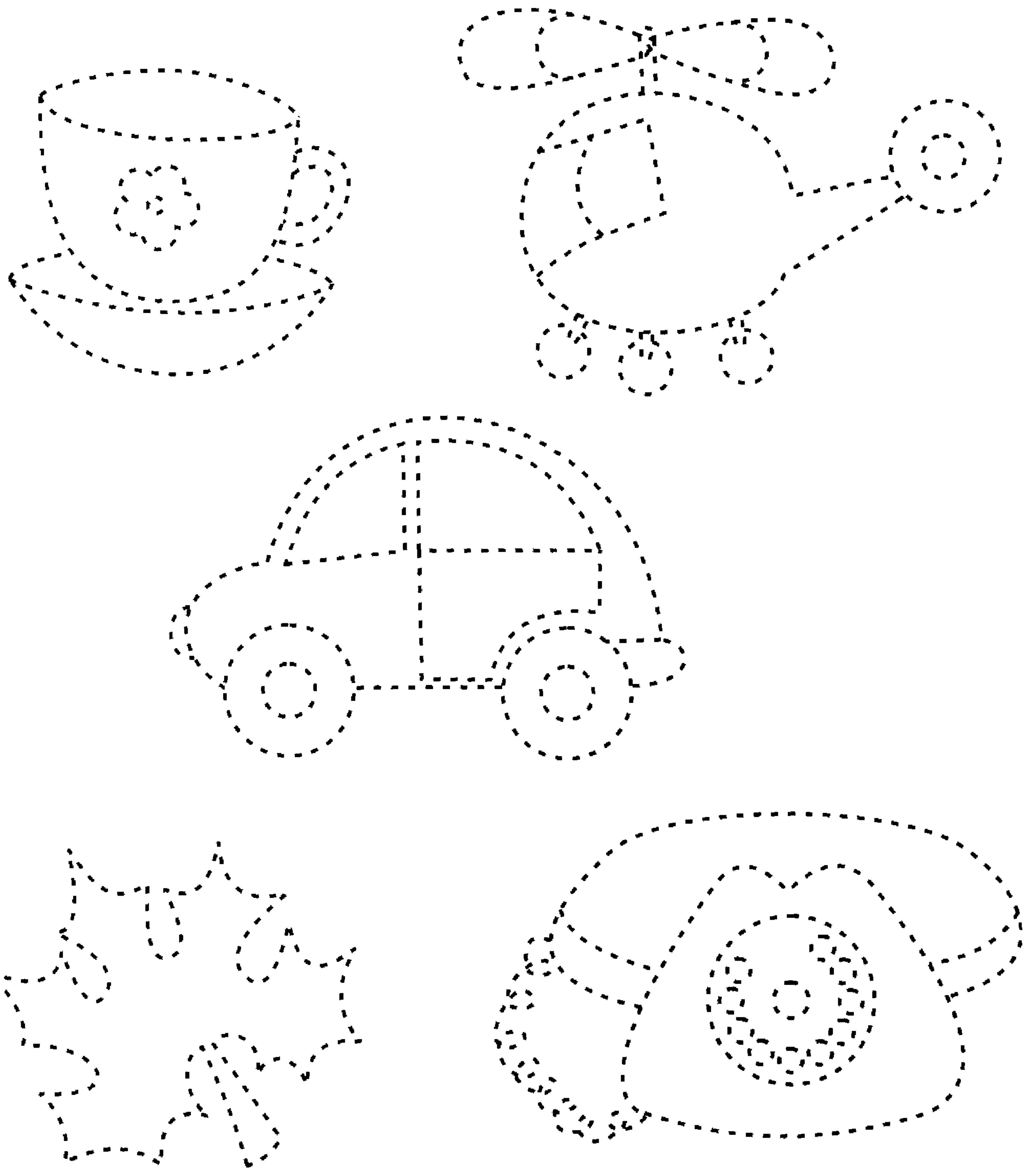

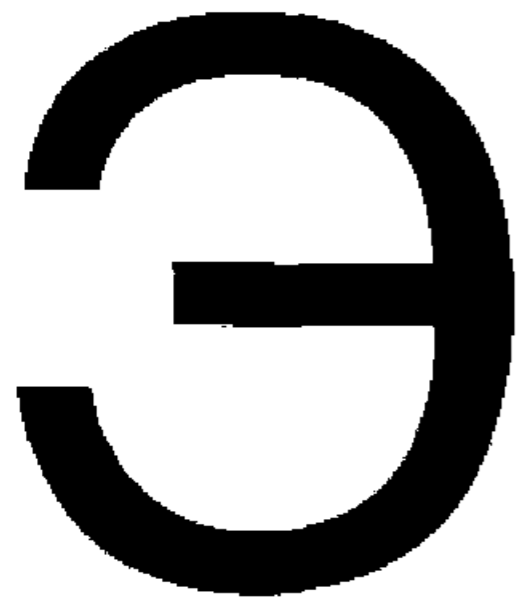

Нет такого животного, в названии  
которого была бы буква «Э».  
Нарисуй любое животное  
и раскрась его.

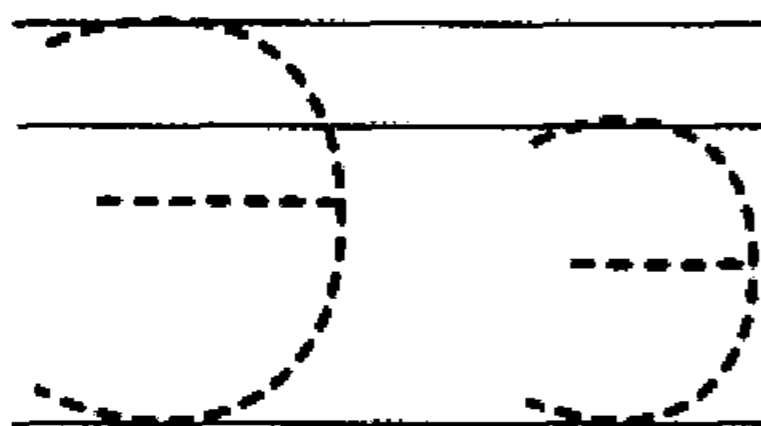
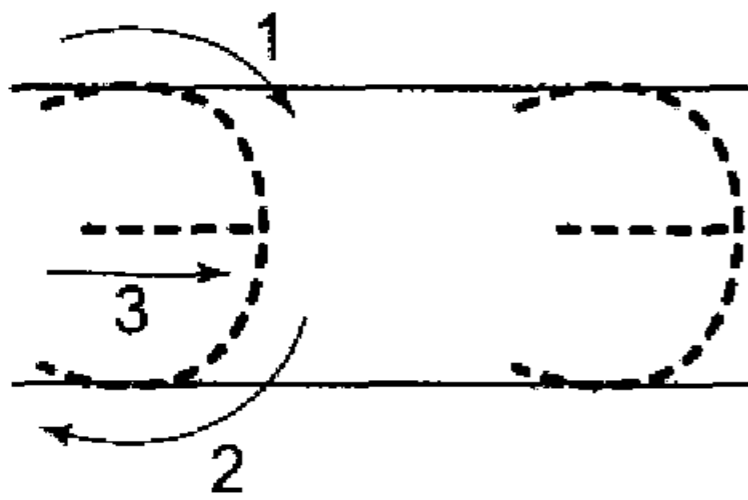
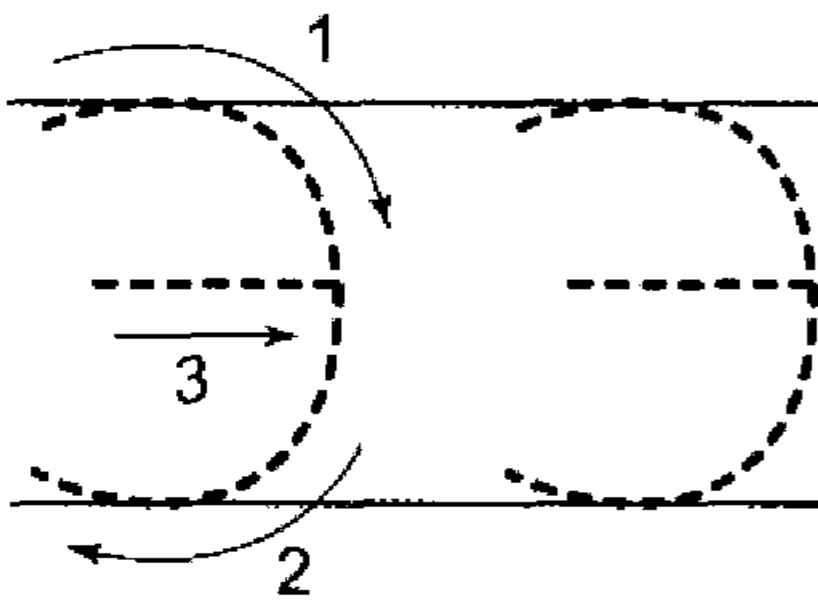

# Ю

Тюлень

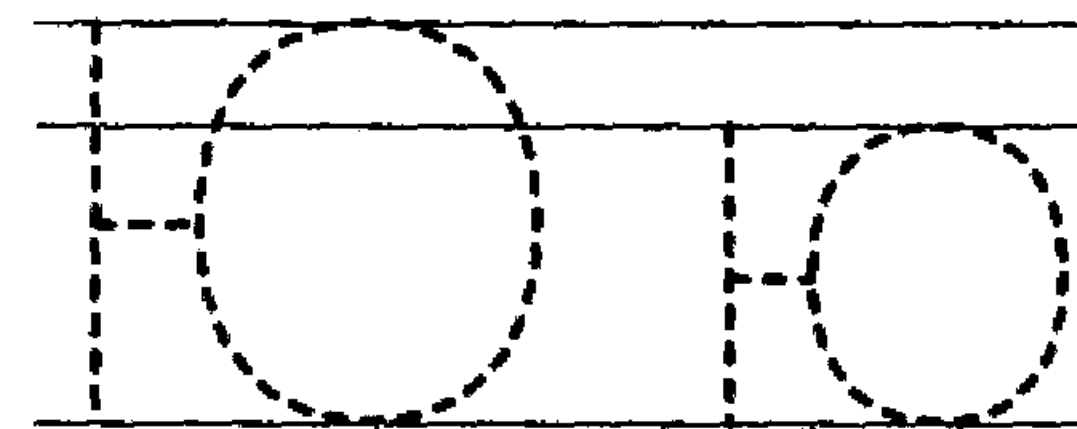
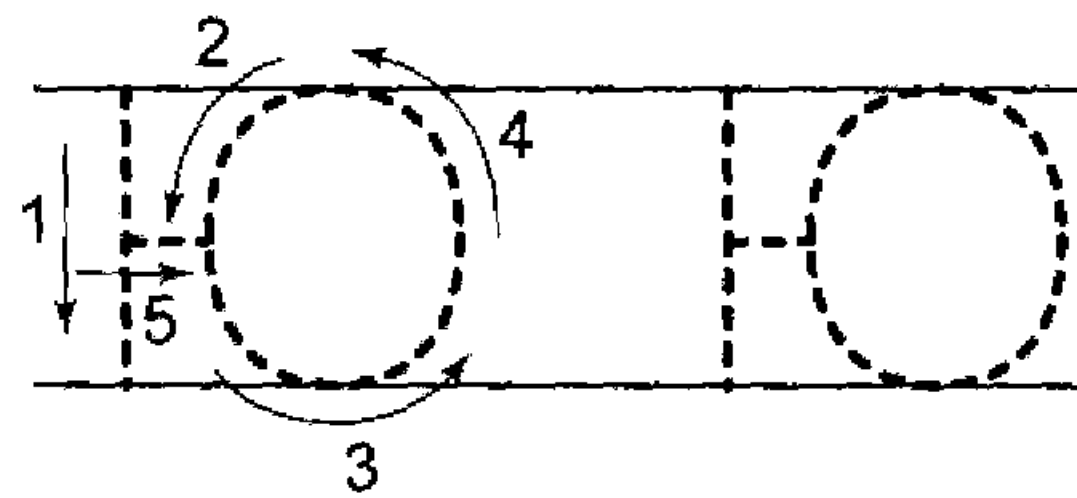
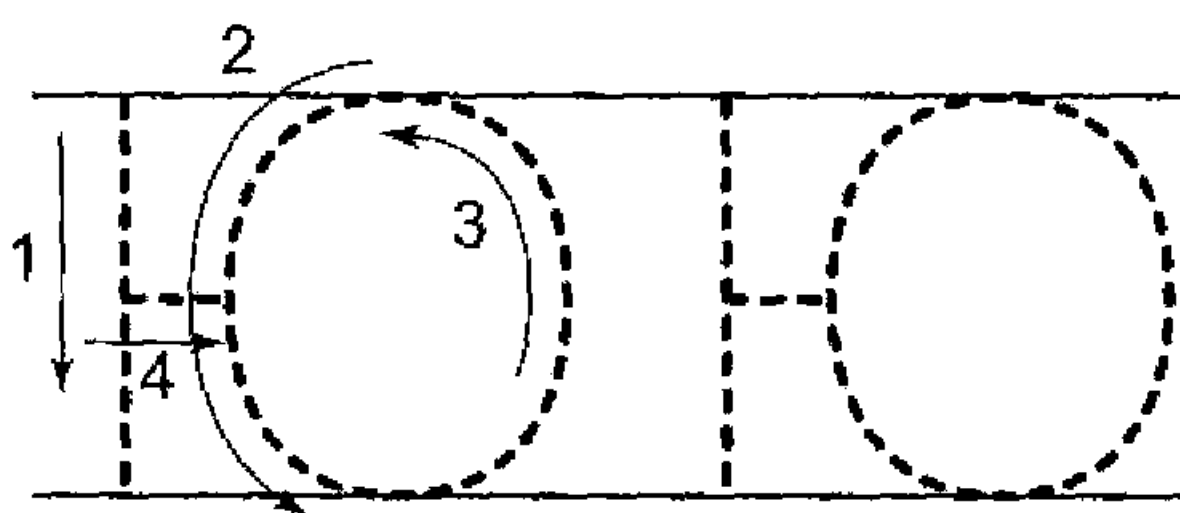
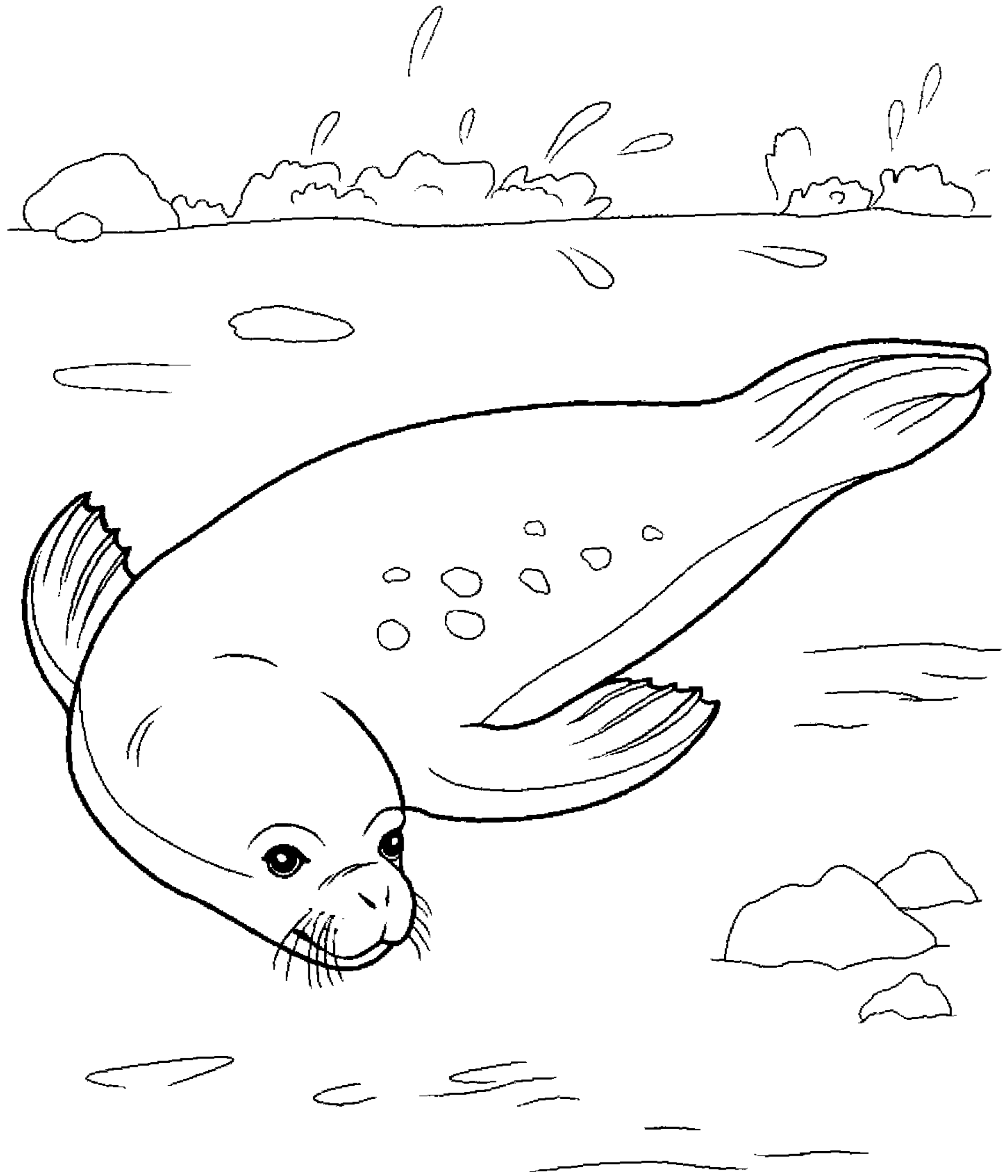



Дорисуй картинки по пунктирным линиям и раскрась.

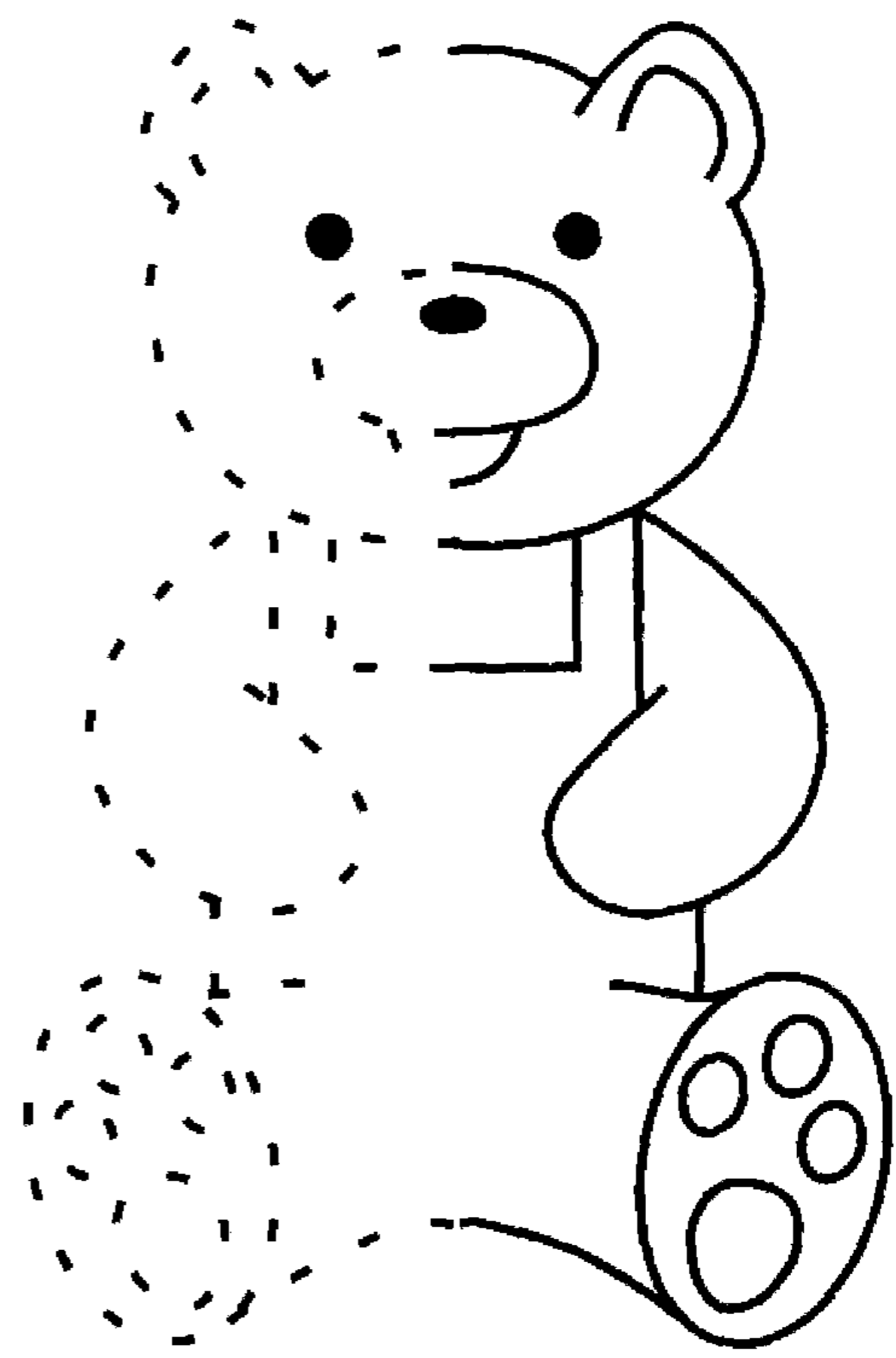
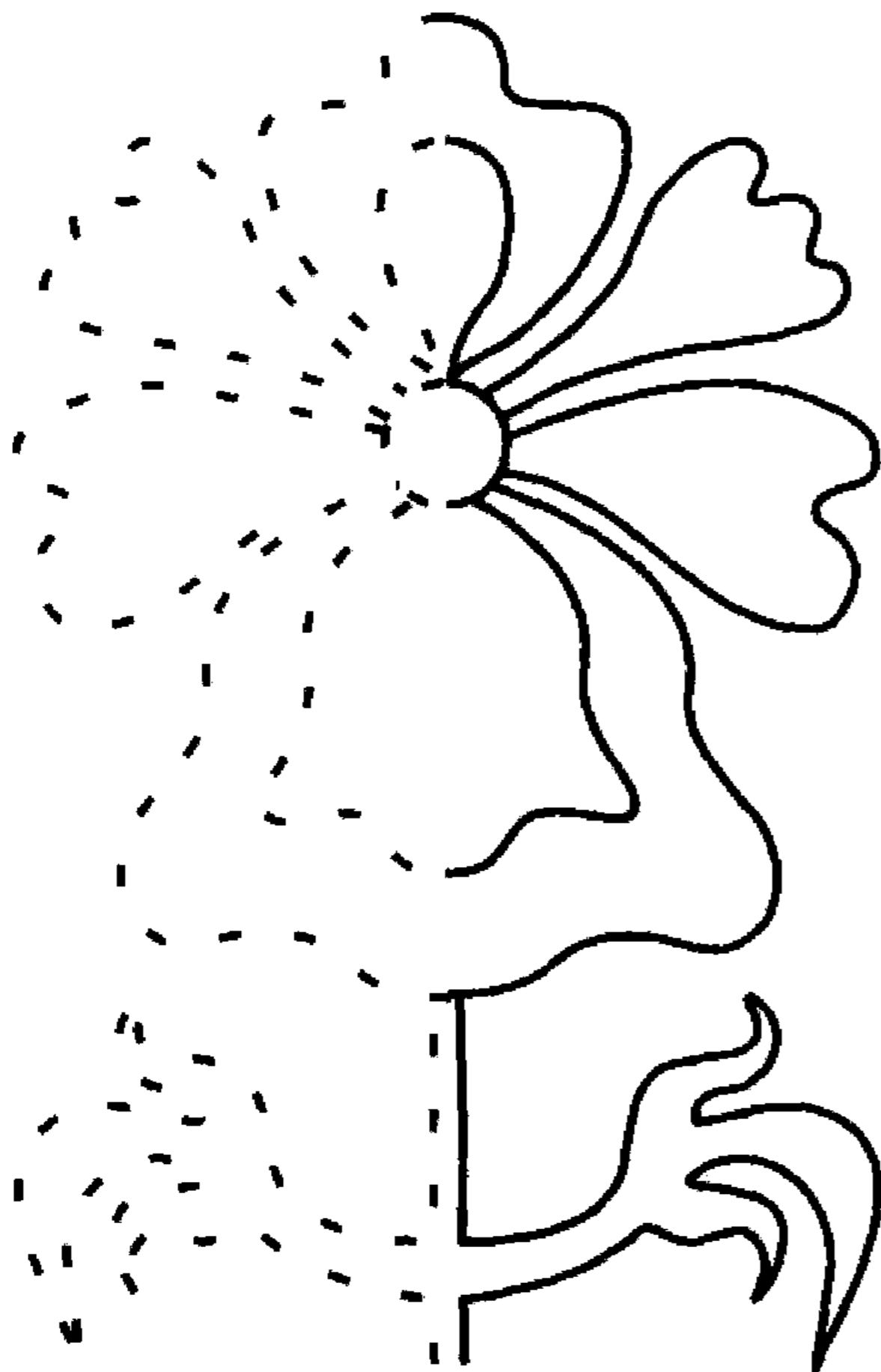
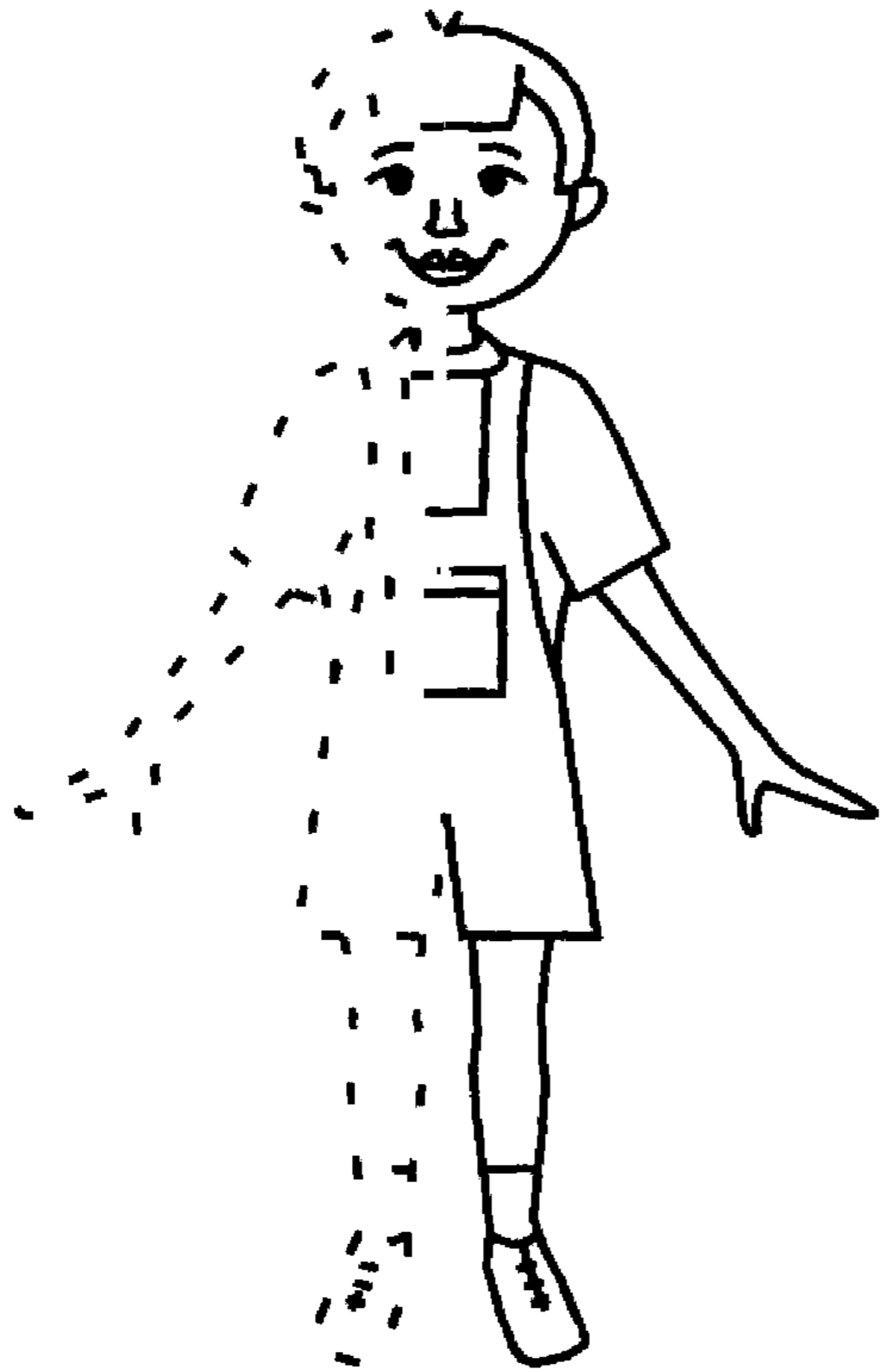



# Соедини буквы от А до Я. Раскрась рисунок.

